

HI83308

Multiparameter Photometer for Water Conditioning



INSTRUCTION MANUAL

Dear
Customer,

Thank you for choosing a Hanna Instruments product.

Please read this instruction manual carefully before using this instrument.

This manual will provide you with the necessary information for correct use of this instrument, as well as a precise idea of its versatility.

If you need additional technical information, do not hesitate to e-mail us at tech@hannainst.com or view our worldwide contact list at www.hannainst.com.

All rights are reserved. Reproduction in whole or in part is prohibited without the written consent of the copyright owner, Hanna Instruments Inc., Woonsocket, Rhode Island, 02895, USA.

TABLE OF CONTENTS

1. PRELIMINARY EXAMINATION	5
2. SAFETY MEASURES	5
3. SPECIFICATIONS	6
4. ABBREVIATIONS	7
5. DESCRIPTION	8
5.1. GENERAL DESCRIPTION & INTENDED USE	8
5.2. PRECISION & ACCURACY	8
5.3. FUNCTIONAL DESCRIPTION	9
5.4. PRINCIPLE OF OPERATION	10
5.5. OPTICAL SYSTEM	11
6. GENERAL OPERATIONS	12
6.1. POWER CONNECTION & BATTERY MANAGEMENT	12
6.2. MODE SELECTION	12
6.3. GENERAL SETUP	13
6.4. CONTEXTUAL HELP	16
7. LOGGING DATA & DATA MANAGEMENT	17
7.1. LOGGING DATA	17
7.2. ADDING SAMPLE & USER NAMES TO LOG DATA	17
7.3. DATA MANAGEMENT	18
8. PHOTOMETER MODE	19
8.1. METHOD SELECTION	19
8.2. COLLECTING & MEASURING SAMPLES AND REAGENTS	19
8.3. CUVETTE PREPARATION	20
8.4. TIMERS & MEASUREMENT FUNCTIONS	22
8.5. CHEMICAL FORMULA & UNIT CONVERSION	22
8.6. METER VALIDATION & CAL CHECK	23
8.7. ABSORBANCE MEASUREMENTS	24
9. PROBE MODE	25
9.1. pH MEASUREMENT	25
9.2. pH CALIBRATION	26
9.3. pH MESSAGES & WARNINGS	27
9.4. pH GLP	28
9.5. pH ELECTRODE CONDITIONING & MAINTENANCE	29

10. METHOD PROCEDURES	31
10.1. AMMONIA LOW RANGE.....	31
10.2. AMMONIA MEDIUM RANGE	34
10.3. AMMONIA HIGH RANGE	37
10.4. CHLORINE, FREE	40
10.5. CHLORINE, TOTAL	43
10.6. COPPER LOW RANGE	47
10.7. COPPER HIGH RANGE.....	49
10.8. FLUORIDE LOW RANGE.....	51
10.9. IRON LOW RANGE.....	53
10.10. IRON HIGH RANGE.....	56
10.11. MANGANESE LOW RANGE.....	58
10.12. MANGANESE HIGH RANGE.....	61
10.13. MOLYBDENUM	64
10.14. NICKEL LOW RANGE	67
10.15. NICKEL HIGH RANGE	70
10.16. NITRATE.....	72
10.17. OXYGEN, DISSOLVED	75
10.18. pH.....	78
10.19. PHOSPHATE LOW RANGE.....	80
10.20. PHOSPHATE HIGH RANGE.....	82
10.21. SILICA LOW RANGE	85
10.22. SILVER.....	88
10.23. ZINC	92
11. WARNINGS & ERRORS	94
12. STANDARD METHODS	97
13. ACCESSORIES.....	98
13.1. REAGENT SETS.....	98
13.2. pH ELECTRODES	100
13.3. pH SOLUTIONS.....	101
13.4. OTHER ACCESSORIES	103
CERTIFICATION	105
RECOMMENDATIONS FOR USERS.....	105
WARRANTY	106

1. PRELIMINARY EXAMINATION

Remove the instrument and accessories from the packaging and examine it carefully. For further assistance, please contact your local Hanna Instruments Office or email us at tech@hannainst.com. Each HI83308 is delivered in a rugged carrying case and is supplied with:

- Sample cuvette (4 pcs.)
- Sample cuvette cap (4 pcs.)
- Cloth for wiping cuvettes
- Scissors
- USB cable
- 5 Vdc power adapter
- 60 mL glass bottle
- Instrument quality certificate
- Instruction manual

Note: Save all packing material until you are sure that the instrument works correctly. Any damaged or defective item must be returned in its original packing material with the supplied accessories.

2. SAFETY MEASURES



- The chemicals contained in the reagent kits may be hazardous if improperly handled.
- Read the Safety Data Sheets (SDS) before performing tests.
- Safety equipment: Wear suitable eye protection and clothing when required and follow instructions carefully.
- Reagent spills: If a reagent spill occurs, wipe up immediately and rinse with plenty of water. If reagent contacts skin, rinse the affected area thoroughly with water. Avoid breathing released vapors.
- Waste disposal: For proper disposal of reagent kits and reacted samples, contact a licensed waste disposal provider.

3. SPECIFICATIONS

Measurement Channels		4 x optical channels
		1 x digital electrode channel (pH measurement)
Photometer	Range	0.000 to 4.000 Abs
	Resolution	0.001 Abs
	Accuracy	± 0.003 Abs @ 1.000 Abs
	Light source	Light Emitting Diode
	Bandpass filter bandwidth	8 nm
	Bandpass filter wavelength accuracy	± 1.0 nm
	Light detector	Silicon photocell
	Cuvette types	Round, 24.6 mm diameter
	Number of methods	27
Probe	Range	-2.00 to 16.00 pH (± 1000.0 mV)*
	Resolution	0.01 pH (0.1 mV)
	Accuracy	± 0.01 pH (± 0.2 mV) @ 25 °C / 77 °F
	Temperature compensation	ATC, -5.0 to 100.0 °C (23.0 to 212.0 °F)*
	Calibration	two-point, from five available buffers (4.01, 6.86, 7.01, 9.18, 10.01 pH)
	Electrode	Intelligent pH / temperature electrode
Temperature	Range	-20.0 to 120.0 °C (-4.0 to 248.0 °F)
	Resolution	0.1 °C (0.1 °F)
	Accuracy	± 0.5 °C @ 25 °C (± 0.9 °F @ 77 °F)
Additional Specifications	Logging	1000 readings (mixed photometer and electrode)
	Display	128 x 64 pixel B/W LCD with backlight
	USB-A (Host) functions	Mass-storage host
	USB-B (Device) functions	Power input, mass-storage device
	Battery life	> 500 photometer measurements or 50 hours of continuous pH measurement
	Power supply	5 Vdc USB 2.0 power adapter / type micro-B connector 3.7 Vdc Li-polymer rechargeable battery, non-serviceable
	Environment	0 to 50 °C (32 to 122 °F) 0 to 95% RH, non-serviceable
	Dimensions	206 x 177 x 97 mm (8.1 x 7.0 x 3.8")
	Weight	1.0 kg (2.2 lbs.)

*Limits will be reduced to actual probe / sensor limits.

4. ABBREVIATIONS

Abs	Absorbance
GLP	Good Laboratory Practice
NIST	National Institute of Standards and Technology
EPA	US Environmental Protection Agency
g/L	grams per liter (ppt)
$\mu\text{g/L}$	micrograms per liter (ppb)
mg/L	milligrams per liter (ppm)
mL	milliliter
HR	High Range
MR	Medium Range
LR	Low Range

5. DESCRIPTION

5.1. GENERAL DESCRIPTION & INTENDED USE

HI83308 multiparameter photometer is a compact and versatile meter with two measurement modes, Photometer and Probe. Photometer mode includes a CAL Check™ feature and 27 different methods that cover a wide variety of applications, making it ideal for both benchtop and portable operations. With the CAL Check feature users are able to validate the performance of the instrument and apply a user calibration (if necessary). Hanna Instruments CAL Check cuvettes are made with NIST traceable standards. Probe mode uses a digital pH probe with a one or two-point calibration.

- Digital electrode input for pH measurements
- Certified CAL Check cuvettes to confirm meter functionality
- Dual purpose micro-USB flash drive
- Lithium polymer rechargeable battery
- Auto-off
- Absorbance mode
- User and sample name entry
- GLP features

5.2. PRECISION & ACCURACY

Precision is how closely repeated measurements are to one another. Precision is usually expressed as standard deviation. Accuracy is defined as the closeness of a test result to the true value. Although good precision suggests good accuracy, precise results can be inaccurate. The figure explains these definitions. For each method, the accuracy is expressed in the related measurement section.

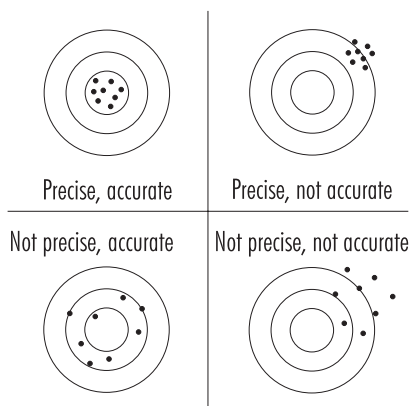



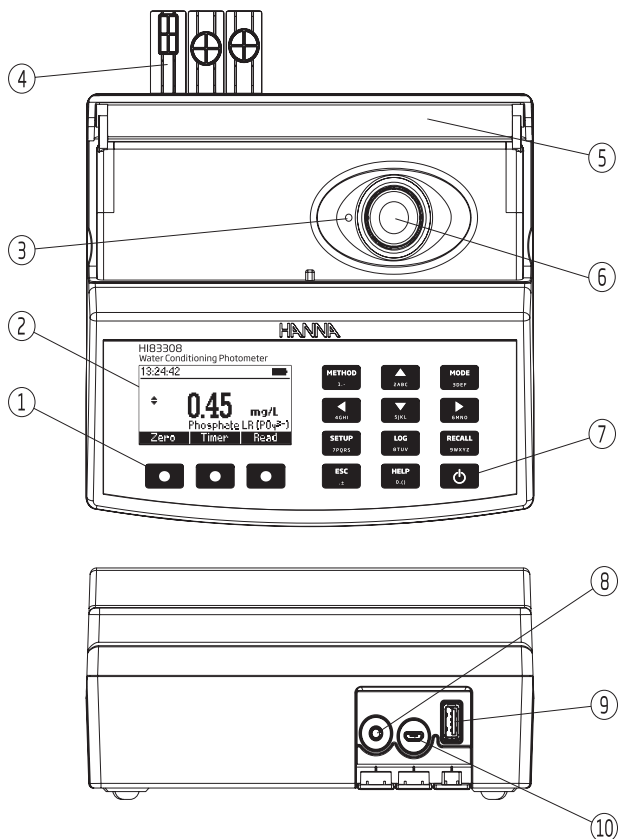









5.3. FUNCTIONAL DESCRIPTION



1. Splash-proof keypad
2. Liquid Crystal Display (LCD)
3. Indexing mark
4. Protective port covers
5. Light-blocking cover panel
6. Cuvette holder
7. ON/OFF power button
8. 3.5 mm TRRS (jack) input for digital electrodes
9. Standard USB host connector for data transfer to a USB flash drive
10. Micro-USB device connector for power or PC interface

Keypad Description

The keypad contains 12 direct keys and 3 functional keys with the following functions:

-  Press the functional key to perform the function displayed above it on the LCD.
-  Press to access the list of photometer methods.
-  Press to move up in a menu or a help screen, to increment a set value or to access second level functions.
-  Press to toggle between photometer and probe (pH electrode) mode.
-  Press to move left in a menu or to decrement a set value.
-  Press to move down in a menu or a help screen, to decrement a set value or to access second level functions.
-  Press to move right in a menu or to increment a set value.
-  Press to access the setup screen.
-  Press to log the current reading.
-  Press to review saved logs.
-  Press to exit the current screen.
-  Press to display the help screen.
-  ON/OFF power button

5.4. PRINCIPLE OF OPERATION

Absorption of light is a typical phenomenon of interaction between electromagnetic radiation and matter. When a light beam crosses a substance, some of the radiation may be absorbed by atoms, molecules or crystal lattices. Photometric chemical analysis is based on specific chemical reactions between a sample and reagent to produce a light-absorbing compound.

If pure absorption occurs, the fraction of light absorbed depends both on the optical path length through the matter and on the physical-chemical characteristics of the substance according to the Lambert-Beer Law. If all other factors are constant, the concentration "c" can be calculated from the absorbance of the substance.

Lambert Beer Law:

$$-\log I/I_o = \epsilon_{\lambda} c d$$

or

$$A = \epsilon_{\lambda} c d$$

- I_o = intensity of incident light beam
 I = intensity of light beam after absorption
 ϵ_{λ} = molar extinction coefficient at wavelength λ
 c = molar concentration of the substance
 d = optical path through the substance

5.5. OPTICAL SYSTEM

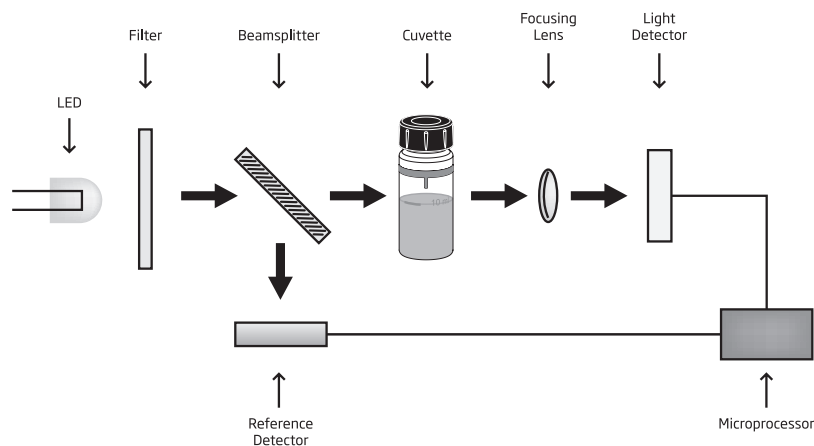

Instrument Block Diagram

The internal reference system (reference detector) of the **HI83308** photometer compensates for any drifts due to power fluctuations or ambient temperature changes, providing a stable source of light for your blank (zero) measurement and sample measurement.

LED light sources offer superior performance compared to tungsten lamps. LEDs have a much higher luminous efficiency, providing more light while using less power. They also produce little heat, which could otherwise affect electronic stability. LEDs are available in a wide array of wavelengths, whereas tungsten lamps have poor blue / violet light output.

Improved optical filters ensure greater wavelength accuracy and allow a brighter, stronger signal to be received. The end result is higher measurement stability and less wavelength error.

A focusing lens collects all of the light that exits the cuvette, eliminating errors from cuvette imperfections and scratches, eliminating the need to index the cuvette.

6. GENERAL OPERATIONS

6.1. POWER CONNECTION & BATTERY MANAGEMENT

The meter can be powered from an AC / DC adapter (included) or from the built-in rechargeable battery.

The meter will perform an auto-diagnostic test when it is first powered on. During this test, the Hanna Instruments logo will appear on the LCD. After 5 seconds, if the test was successful, the last method used will appear on the display.

The battery icon on the LCD will indicate the battery status:

- battery is charging from external adapter
- battery fully charged (meter connected to AC / DC adapter)

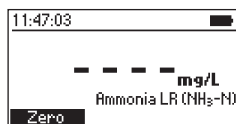
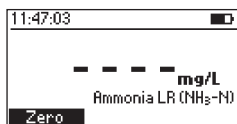

- battery capacity (no external adapter)
- battery near 0% (no external adapter)

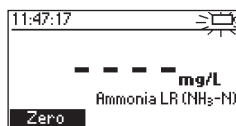
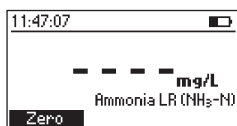

- battery exhausted (no external adapter)

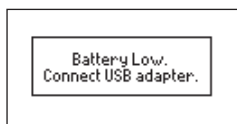

To conserve battery, the meter will turn off automatically after 15 minutes of inactivity (30 minutes after a Zero measurement). If a photometer measurement is on the screen, an auto-log is created before shutdown.

6.2. MODE SELECTION

The **HI83308** has two operational modes: Photometer and Probe.

Photometer mode enables on-demand measurement of a cuvette using the integrated optical system.

Probe mode enables continuous measurement using a Hanna Instruments digital electrode connected to the 3.5 mm port.

To switch between Photometer mode and Probe mode, use the **MODE** key.

Note: *The active mode cannot be switched while in Setup, Recall or Method menus.*

6.3. GENERAL SETUP

Press the **SETUP** key to enter in **Setup** menu, highlight desired option using the ▲▼ keys and press **Select**.

CAL Check (Photometer Mode Only)

Press **Select** to enter the CAL Check screen. The date, time and values for the last CAL Check are displayed on the screen. To start a new CAL Check press **Check** and follow the prompts on the screen. See METER VALIDATION & CAL CHECK section for additional information.

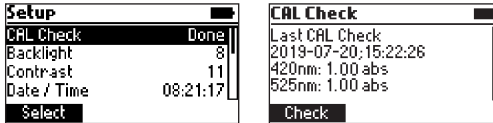

Temperature Unit (Probe Mode Only)

Option: °C or °F

Press the functional key to select the desired temperature unit.

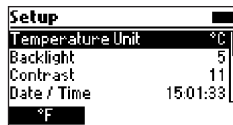

Backlight

Values: 0 to 8

Press **Modify** to access the backlight intensity. Use the functional keys or the ◀▶ keys to increase or decrease the value. Press **Accept** to confirm or press the **ESC** key to return to the **Setup** menu without saving the new value.

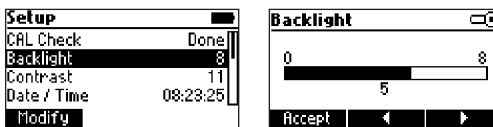

Contrast

Values: 0 to 20

Press **Modify** to change the display's contrast. Use the functional keys or the ◀▶ keys to increase or decrease the value. Press **Accept** to confirm the value or the **ESC** key to return to the **Setup** menu without saving the new value.

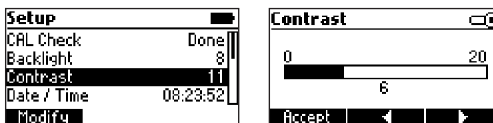

Date & Time

Press **Modify** to change the date and time. Press the functional keys or the ◀▶ keys to highlight the value to be modified (year, month, day, hour, minute or second). Use the ▲▼ keys to change the value. Press **Accept** to confirm or **ESC** key to return to the **Setup** without saving the new date or time.

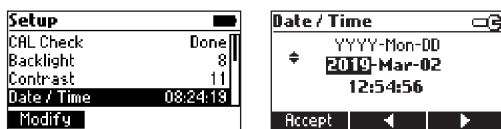

Time Format

Option: AM/PM or 24-hour

Press the functional key to select the desired time format.

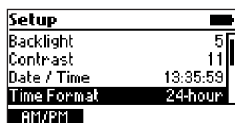

Date Format

Option: DD/MM/YYYY, MM/DD/YYYY, YYYY/MM/DD, YYYY-MM-DD, Mon DD, YYYY, DD-Mon-YYYY, YYYY-Mon-DD

Press **Modify** to change the date format. Use the ▲▼ keys to select the desired format. Press **Select** to confirm or the **ESC** key to return to the **Setup** menu without saving the new format.

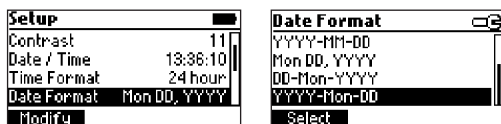

Decimal Separator

Option: Comma (,) or Period (.)

Press the functional key to select the desired decimal separator. The decimal separator is used on the measurement screen and CSV (Comma-Separated Values) files.

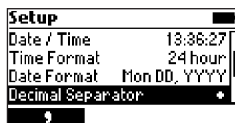

Language

Option: Português, Deutsch, English, Español, Français, Italiano, Dutch

Press **Modify** to change the language. Use the ▲▼ keys to select the desired language. Press **Select** to change the language.



Beeper

Option: Enable or Disable

When enabled, a short beep is heard every time a key is pressed. A long beep alert sounds when the pressed key is not active or an error is detected. Press the functional key to enable or disable the beeper.

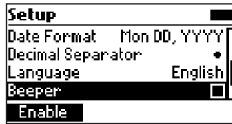

Instrument ID

Option: 0 to 999999

This option is used to set the instrument's ID (identification number). Press **Modify** to access the instrument ID screen. Use the functional keys or the ◀▶ keys to highlight the digit to be modified. Press the ▲▼ keys in order to set the desired value. Press **Accept** to confirm the value or press the ESC key to return to the **Setup** menu without saving the new value.



Meter Information

Press **Select** to view the model, serial number, firmware version and selected language. Press the ESC key to return to the **Setup** menu.

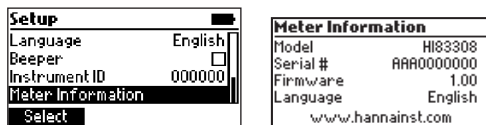

Probe Information (Probe Mode Only)

Press **Select** to view model number, serial number and firmware version for the connected probe. Press the **ESC** key to return to the **Setup** menu.

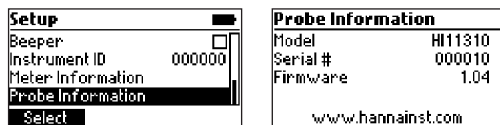

6.4. CONTEXTUAL HELP

HI83308 offers an interactive contextual help mode that assists the user at any time.

To access the help screen press the **HELP** key. The instrument will display additional information related to the current screen. To read all the available information, scroll the text using the **▲▼** keys. Press the **ESC** key to return to the previous screen.

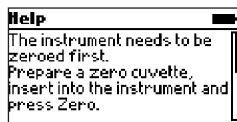

7. LOGGING DATA & DATA MANAGEMENT

The instrument features a data log function to help the user to keep track of measurements. The data log can hold 1000 individual measurements. Storing, viewing and deleting the data is possible using the **LOG** and **RECALL** keys.

7.1. LOGGING DATA

Press the **LOG** key and the last valid measurement will be stored with a date and time stamp. Only valid measurements can be stored.

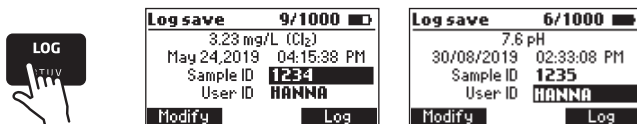

7.2. ADDING SAMPLE & USER NAMES TO LOG DATA

A sample ID and user ID can be added to the saved log. Use the ▲▼ keys to highlight the Sample ID or User ID then press **Modify**. Sample ID and user ID are entered using the alphanumeric multi-tapping keypad.

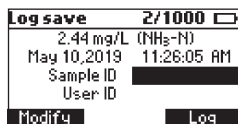

Enter one character at a time by pressing the key with the assigned character repeatedly until the desired character is highlighted. For reference, a list of the characters available for the current key will be shown under the text box.

The character will be entered after a two-second delay or after another key is pressed.

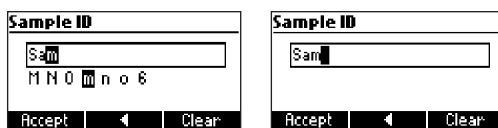

Press **Accept** to update the sample or user ID.

Press ◀ functional key to delete the last character.

Press **Clear** to delete all of the characters.

Press the **ESC** key to discard all changes and return to the previous screen.

7.3. DATA MANAGEMENT

Viewing & Deleting

Data can be viewed, deleted and exported to a USB drive or a PC by pressing the **RECALL** key. Use the **▲▼** keys to scroll through the saved logs. Press **Info** to view additional information about the selected log.

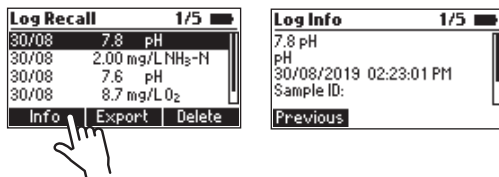

Use **Delete** to erase logged data. After pressing **Delete** the prompt on the display will confirm the action.

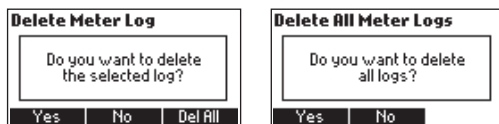

Press **No** or the **ESC** key to return to the previous screen.

Press **Yes** to delete the selected log.

Press **Del All** to erase all the logged data. If **Del All** is pressed the prompt on the display will confirm the action. Press **Yes** to delete all logged data, **No** or the **ESC** key to return to the log recall.

Data Export

Log data can be exported to a USB flash drive or to a PC. To access data export functions, press the **RECALL** key then **Export**.

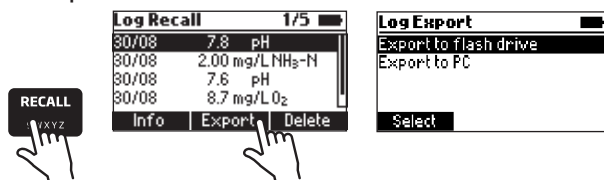

Use the **▲▼** keys to select the desired export location.

For export to flash drive, insert the USB flash drive into the dedicated port at the back of the meter labeled **HOST USB**, then follow the on-screen prompts.

For export to PC, connect the meter to a PC using the supplied micro-USB cable. Insert the cable into the port at the back of the meter labeled **PC PWR**. Follow the on-screen prompts. When the display informs that the PC is connected, the meter will appear as a removable disk. Use a file manager (such as Windows Explorer or Mac Finder) to move the file from the meter to the PC.

Log data is exported as a single file (H183308.csv) containing all logged photometer and probe data. The CSV file may be opened with a text editor or spreadsheet application.

8. PHOTOMETER MODE

8.1. METHOD SELECTION

In order to select the desired method press the **METHOD** key and a screen with the available methods will appear.

Press the ▲▼ keys to highlight the desired method. Press **Select**.

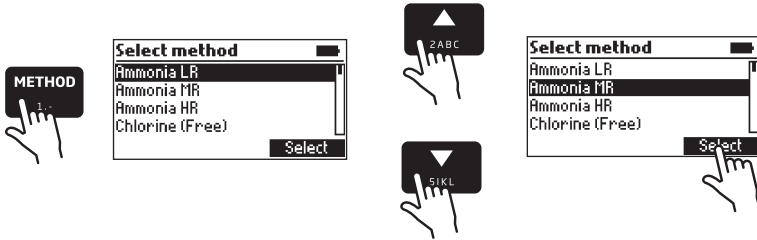

After the desired method is selected, follow the procedure described in the related section. Before performing a method, read all the instructions carefully.

8.2. COLLECTING & MEASURING SAMPLES AND REAGENTS

Proper Use of Syringe

1. Push the plunger completely into the syringe and insert the tip into the solution.
2. Pull the plunger up until the lower edge of the seal is exactly on the mark for the desired volume.
3. Take out the syringe and clean the outside of the syringe tip, be sure that no drops are hanging on the tip of the syringe. Then, keeping the syringe in a vertical position, push the plunger down into the syringe, the desired volume has been delivered.

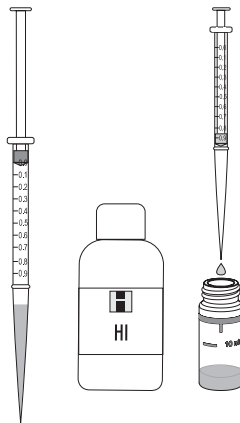

Proper Use of Dropper Bottle

1. Tap the dropper on the table several times.
2. Remove the cap and wipe the outside of the tip with a cloth.
3. Keep the dropper bottle in a vertical position while dosing the reagent.

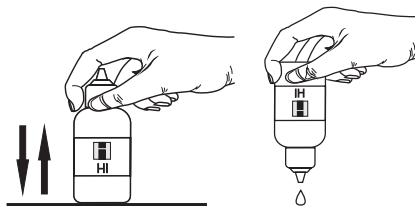

Proper Use of Powder Packet

1. Use scissors to open the powder packet.
2. Push the edges of the packet to form a spout.
3. Pour out the content of the packet.

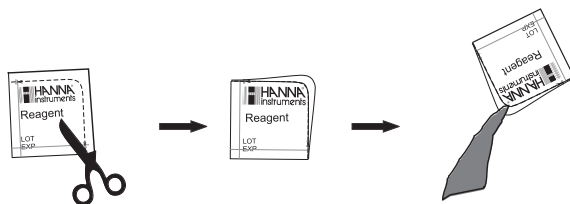

8.3. CUVETTE PREPARATION

Proper mixing is very important for reproducibility of the measurements. The proper mixing technique for each method is listed in the method procedure.

- (a) Invert the cuvette a couple of times or for a specified time: hold the cuvette in the vertical position. Turn the cuvette upside-down and wait for all of the solution to flow to the cap end, then return the cuvette to the upright vertical position and wait for all of the solution to flow to the cuvette bottom. This is one inversion. The correct speed for this mixing technique is 10 to 15 complete inversions in 30 seconds. This mixing technique is indicated with “invert to mix” and one of the following icons:

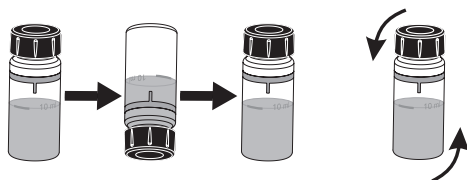

- (b) Shaking the cuvette, moving the cuvette up and down. The movement may be gentle or vigorous. This mixing technique is indicated with “shake gently” or “shake vigorously”, and one of the following icons:

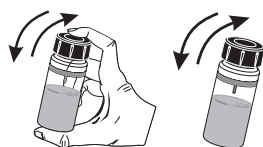

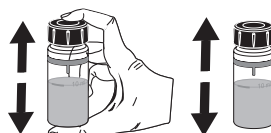

shake gently

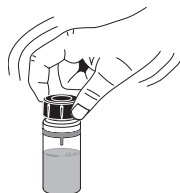

shake vigorously

- (c) Swirl the cuvette gently to mix the solution. This mixing technique is indicated with one of the following icons:



In order to avoid reagent leaking and to obtain more accurate measurements, close the cuvette first with the supplied High-Density Polyethylene (HDPE) plastic stopper  and then the black cap.



Whenever the cuvette is placed into the measurement holder, it must be dry outside and free of fingerprints, oil and dirt. Wipe it thoroughly with [HI731318](#) microfiber cleaning cloth or a lint-free wipe prior to insertion. Shaking the cuvette can generate bubbles in the sample, causing higher readings. To obtain accurate measurements, remove such bubbles by swirling or by gently tapping the cuvette.

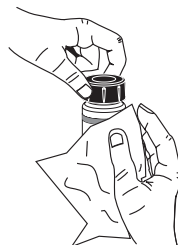

Do not let the reacted sample stand too long after reagent is added. For best accuracy, respect the timings described in each specific method.

It is possible to take multiple readings in a row, but it is recommended to take a new zero reading for each sample and to use the same cuvette for zeroing and measurement when possible.

Discard the sample immediately after the reading is taken, or the glass might become permanently stained.

All the reaction times reported in this manual are at 25 °C (77 °F). In general, the reaction time should be increased for temperatures lower than 20 °C (68 °F) and decreased for temperatures higher than 25 °C (77 °F).

Interferences

In the method measurement section the most common interferences that may be present in a typical water sample have been reported. It is possible that a particular application could introduce other compounds that will also interfere.

8.4. TIMERS & MEASUREMENT FUNCTIONS

Each method requires a different preparation procedure, reaction times and sample preparations. If a timer or timers are necessary for proper sample preparation, the **Timer** will be available.

To use a reaction timer, press **Timer**. The default timer will start immediately. To stop and reset the timer, press **Stop**.

If the selected method requires more than one timer, the meter will automatically select each timer in the appropriate order. To bypass the default order, a different timer may be activated by pressing the desired key (only while the current timer is stopped). Press **Continue** to start the active timer.

For some methods, the timer is only necessary after a Zero measurement has been performed. In this case, the timer key will only be available after the Zero measurement has been performed.

If the method requires a Zero or Read measurement after a timer has expired, the meter will automatically perform the appropriate action. Follow the instructions in the method procedure.

To perform a Zero or Read measurement, insert the prepared cuvette, then press **Zero** or **Read**. A Zero measurement must be conducted before a Read measurement.

8.5. CHEMICAL FORMULA & UNIT CONVERSION

Chemical formula and unit conversion factors are pre-programmed into the instrument and are method specific. In order to view the displayed result in the desired chemical formula press the ▲▼ keys to access the second level function and then press **Chem Frm** to toggle between the available chemical formulas for the selected method.

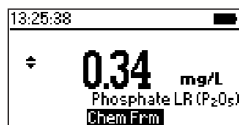
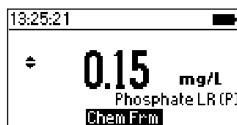

8.6. METER VALIDATION & CAL CHECK

Warning: Do not validate the meter with standard solutions other than the Hanna Instruments® CAL Check Standards. For accurate validation results, please perform tests at room temperature, 18 to 25 °C (64.4 to 77.0 °F).

Validation of the **HI83308** involves absorbance measurements of certified Hanna Instruments CAL Check Standards (see ACCESSORIES section). The CAL Check screen guides the user through the measurement of each CAL Check Standard and applies the factory calibration corrections to each measurement. The **HI83308** stores the results of the most recent CAL Check measurements which may be viewed on the CAL Check screen. Compare these results with the values printed on the Certificate provided with each Hanna Instruments CAL Check Standards kit.

To perform a validation:

1. Press the **SETUP** key.



2. Highlight **CAL Check**, then press **Select**.

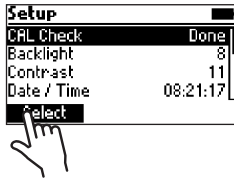

3. Follow the prompts on the screen. The meter will prompt to measure each cuvette provided in the Hanna Instruments CAL Check Standards kit. To exit the process at any time, press **ESC** key.

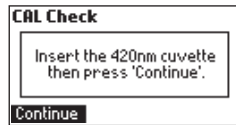
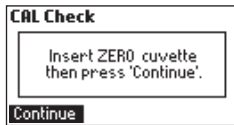
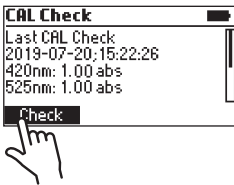

4. Press the **ESC** key to return in **Setup** menu.



8.7. ABSORBANCE MEASUREMENTS

Raw absorbance measurements may be performed on the [HI83308](#) for personal or diagnostic purposes. For example, the stability of a reagent blank may be monitored by occasionally measuring its absorbance versus deionized water.

To measure the raw absorbance of a prepared sample:

1. Press the **METHOD** key. 
2. Highlight the appropriate Absorbance method (according to the wavelength to be used), then press **Select**. Absorbance methods are located at the bottom of the method list.
3. Prepare the sample cuvette according to the method.
4. Insert a cuvette filled with deionized water, then press **Zero**.
5. Insert the prepared sample cuvette, then press **Read**.

Warning: *Never use absorbance methods for validation using Hanna Instruments® CAL Check cuvettes. The factory calibration corrections for CAL Check cuvettes are applied while in CAL Check mode only!*

9. PROBE MODE

9.1. pH MEASUREMENT

The HI83308 can be used to perform direct pH measurements by connecting a Hanna Instruments® digital pH electrode with a 3.5 mm TRRS connector. Connect the electrode to the 3.5 mm port marked with EXT PROBE located at the rear of the meter. If the meter is in Photometer mode, set the meter to Probe mode by pressing the **MODE** key.

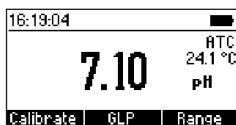

Press **Calibrate** to open the calibration window.

Press **GLP** to review the calibration information.

Press **Range** to switch between pH and mV.

For high accuracy it is recommended to calibrate the electrode often. pH electrodes should be recalibrated at least once per week, but daily calibration is recommended. Always recalibrate after cleaning an electrode, see pH CALIBRATION section for more information.

To take pH measurements:

- Remove the protective cap and rinse the electrode with water.
- Collect some sample in a clean, dry beaker.
- Preferably, rinse the electrode with a small amount of sample.
- Submerge the electrode tip approximately 3 cm (1¼”) into the sample to be tested and stir the sample gently. Make sure the electrode junction is completely submersed.
- Allow time for the electrode to stabilize in the sample. When the ⏱ symbol disappears, the reading is stable.

If measurements are taken successively in different samples, it is recommended to rinse the electrodes thoroughly with deionized or distilled water and then with some of the next sample to prevent cross-contamination.

pH measurements are affected by temperature. Hanna Instruments digital pH electrodes include a built-in temperature sensor and automatically calculate corrected pH values. The measured temperature is displayed on the screen with the pH measurements.

9.2. pH CALIBRATION

From the probe measurement screen, press **Calibrate** to begin the calibration process. During pH calibration, the display will show the current pH reading, temperature reading, selected buffer type and the buffer number (“Buffer: 1” for the first buffer, “Buffer: 2” for the second buffer).

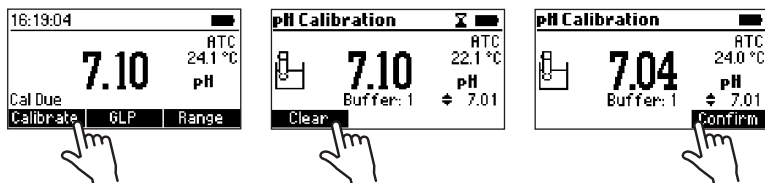

Press **Clear** to clear the current calibration.

Press **Confirm** to accept the current calibration point (only available if the reading is stable and within the limits for the selected buffer).

Press the **▲▼** keys to cycle through the list of available buffers: pH 4.01, 6.86, 7.01, 9.18, 10.01.

Press the **ESC** key to exit calibration and return to pH measurement mode.

Preparation

Pour small quantities of the buffer solutions into clean beakers. If possible, use plastic beakers to minimize any EMC interferences. For accurate calibrations and to minimize cross-contamination, use two beakers for each buffer solution: one for rinsing the electrode and one for calibration. If the sample to be measured is in the acidic range, use pH 7.01 or 6.86 as the first buffer and pH 4.01 as the second buffer. If it is in the alkaline range, use pH 7.01 or 6.86 as the first buffer and pH 10.01 or 9.18 as the second buffer.

Procedure

Calibration can be performed using one or two calibration buffers. For more accurate measurements, a two-point calibration is recommended.

Submerge the pH electrode approximately 3 cm (1¼”) into a buffer solution and stir gently.

When the reading is stable and close to the selected buffer, press **Confirm** to accept and store the calibration point. The meter will prompt for the second buffer (Buffer: 2). To use only a one-point calibration, press the **ESC** key to exit calibration mode. The meter will store the calibration information to the probe and return to measurement mode. To continue calibrating with a second buffer, rinse and submerge the pH electrode approximately 3 cm (1¼”) into the second buffer solution and stir gently. If necessary, use the **▲▼** keys to select a different buffer value.

When the reading is stable and close to the selected buffer, press **Confirm** to accept and store the second calibration point.

The meter will store the two-point calibration information to the probe and return to Measurement mode. The list of calibrated buffers will appear at the bottom of the screen.

9.3. pH MESSAGES & WARNINGS

No Probe

No probe is connected or the probe is broken.

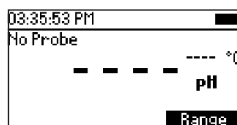

Connecting

The meter has detected a probe and is reading the probe configuration and calibration information.

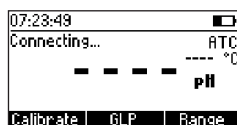

Incompatible Probe

The connected probe is not compatible with this device.

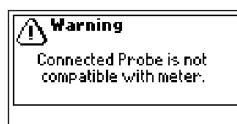

Incompatible Calibration

The probe's current calibration is not compatible with this meter. The calibration must be cleared to use this probe.

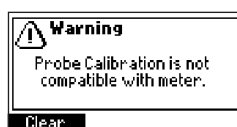

Exceeded Probe Range

The pH and/or temperature measurement exceed the specifications of the probe. The measurement value(s) will be blinking.

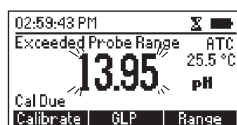

Broken Temperature Sensor

The temperature sensor inside the probe is broken. Temperature compensation will revert to a fixed value of 25 °C (77 °C).

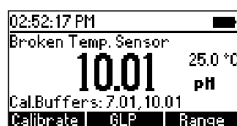

Cal Due

The probe has no calibration. See pH CALIBRATION section for details.

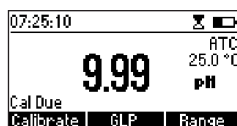

Clean Probe

The offset is outside the accepted window or the slope is under the accepted lower limit. Cleaning the probe will improve the pH electrode's response, repeat the calibration after cleaning. See pH ELECTRODE CONDITIONING & MAINTENANCE section for details.

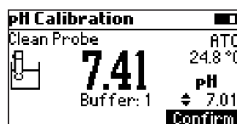

Check Probe & Buffer

There is a large difference between the pH measurement and the selected buffer value or the electrode slope is outside of the accepted slope limit. Clean the probe and confirm the correct buffer selection.

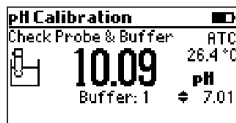

Wrong Temperature

The buffer temperature is outside of the acceptable window for the selected buffer value.

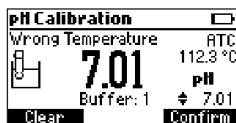

9.4. pH GLP

Good Laboratory Practice (GLP) refers to a quality control function used to ensure uniformity and consistency of sensor calibrations and measurements. To view the GLP information, press the GLP key from the probe measurement screen.

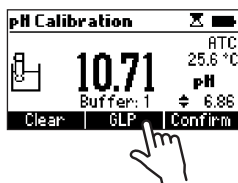

The pH GLP screen displays the date and time, buffers, slope and offset for the last calibration. If the probe has not been calibrated, "No User Calibration" is displayed. Press the ESC key to return to the measurement mode.

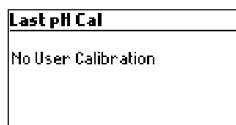
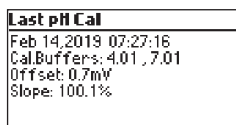

9.5. pH ELECTRODE CONDITIONING & MAINTENANCE

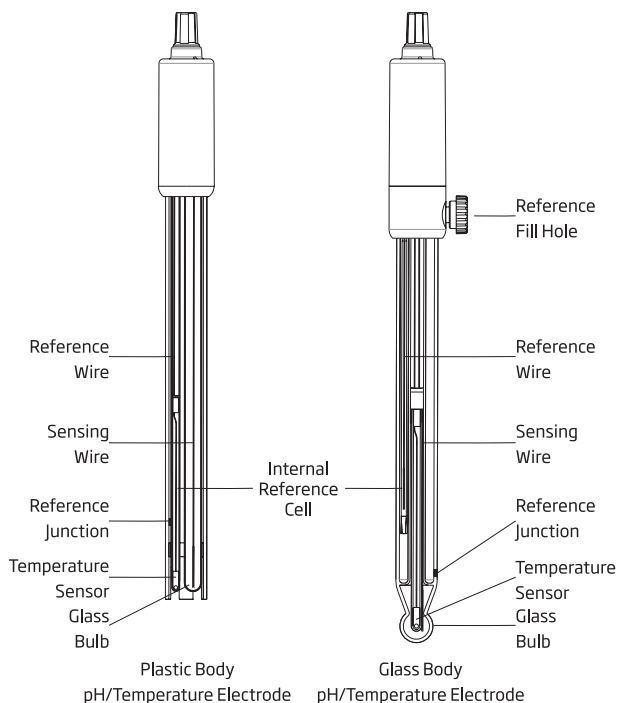

Remove the protective cap. Do not be alarmed if salt deposits are present, this is normal. Rinse the probe with water.

Shake the electrode like a clinical thermometer to eliminate any air bubbles inside the glass bulb. If the bulb and / or junction are dry, soak the electrode in [HI70300](#) or [HI80300](#) Storage solution for a minimum of 30 minutes. Rinse with water. Calibrate before using.

For refillable electrodes if the filling solution (electrolyte) is more than 2½ cm (1”) below the fill hole, add [HI7082](#) or [HI8082](#) 3.5M KCl Electrolyte solution. Unscrew the fill hole cover during measurements so the liquid reference junction maintains an outward flow of electrolyte.

Storage Procedure

To minimize clogging and ensure a quick response time, the glass bulb and the junction should be kept moist and not allowed to dry out.

Replace the solution in the protective cap with a few drops of [HI70300](#) or [HI80300](#) Storage solution or Filling solution ([HI7082](#) or [HI8082](#) 3.5M KCl Electrolyte solution). pH 4.01 or 7.01 buffer can also be used.

Note: Never store the electrode in distilled or deionized water.

Periodic Maintenance

Inspect the electrode and the cable. The cable used for connection to the instrument must be intact and there must be no points of broken insulation on the cable, connectors must be perfectly clean and dry. If there are any scratches or cracks on the electrode stem or bulb, replace the electrode.

For refillable electrodes, refill the reference chamber with fresh electrolyte (HI7082 or HI8082 3.5M KCl Electrolyte solution). Allow the electrode to stand upright for 1 hour.

Cleaning Procedure

Several cleaning solutions are available:

- General — Soak in HI7061 or HI8061 General cleaning solution for approximately 30 minutes.
- Protein — Soak in HI7073 or HI8073 Protein cleaning solution for 15 minutes.
- Inorganic — Soak in HI7074 Inorganic cleaning solution for 15 minutes.
- Oil and grease — Rinse with HI7077 or HI8077 Oil and fat cleaning solution.

After performing any of the cleaning procedures, rinse the electrode thoroughly with distilled water, refill the reference chamber with fresh electrolyte (refillable electrodes only) and soak the electrode in HI70300 or HI80300 Storage solution for at least 1 hour before taking measurements.

Temperature Correlation for pH Sensitive Glass

Verify the temperature range by reading the limits on electrode's cap. The pH electrode's life is temperature dependent. If constantly cycled between two temperatures, the life of the electrode is drastically reduced.

10. METHOD PROCEDURES

10.1. AMMONIA LOW RANGE

SPECIFICATIONS

Range	0.00 to 3.00 mg/L (as NH ₃ -N)
Resolution	0.01 mg/L
Accuracy	±0.04 mg/L ±4% of reading at 25 °C
Light Source	LED with narrow band interference filter @ 420 nm
Method	Adaptation of the ASTM Manual of Water and Environmental Technology, D1426 Nessler Method

REQUIRED REAGENTS

Code	Description	Quantity
HI93700A-0	Ammonia Low Range Reagent A	4 drops
HI93700B-0	Ammonia Low Range Reagent B	4 drops

REAGENT SETS

HI93700-01	Reagents for 100 tests
HI93700-03	Reagents for 300 tests

For other accessories see ACCESSORIES section.

MEASUREMENT PROCEDURE

- Select the **Ammonia LR** method using the procedure described in the METHOD SELECTION section.

- Fill the cuvette with 10 mL of unreacted sample (up to the mark).
Replace the plastic stopper and the cap.



- Insert the cuvette into the holder and close the lid.

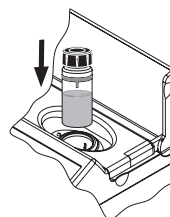

- Press **Zero**. The display will show “-0.0-” when the meter is zeroed and ready for measurement.

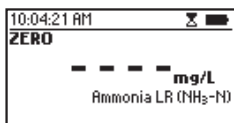
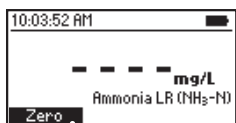

- Remove the cuvette.
- Add 4 drops of **HI93700A-0** Ammonia Low Range Reagent A. Replace the plastic stopper and the cap. Swirl to mix the solution.

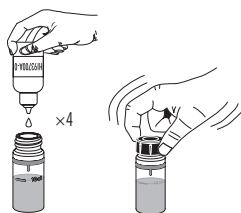

- Add 4 drops of **HI93700B-0** Ammonia Low Range Reagent B. Replace the plastic stopper and the cap. Swirl to mix the solution.

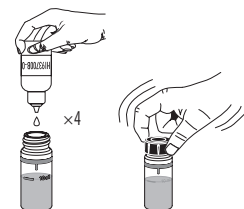

- Insert the cuvette into the holder and close the lid.

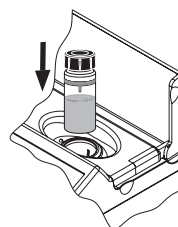

- Press **Timer** and the display will show the countdown prior to the measurement or wait 3 minutes and 30 seconds and press **Read**. When the timer ends the meter will perform the reading. The instrument displays the results in **mg/L** of **ammonia nitrogen (NH₃-N)**.

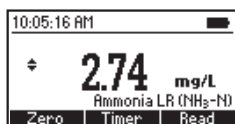
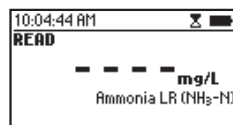
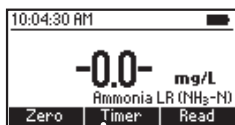

- Press the **▲** or **▼** key to access the second level functions.

- Press **Chem Frm** to convert the result to mg/L of ammonia (NH_3) and ammonium (NH_4^+).

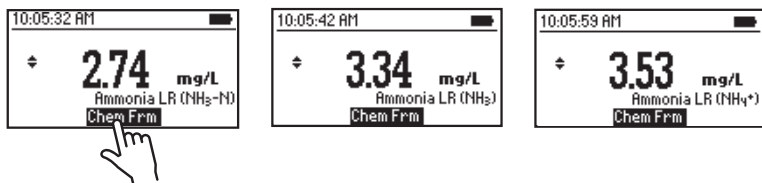

- Press the ▲ or ▼ key to return to the measurement screen.

INTERFERENCES

Interference may be caused by:

- Hardness above 1 g/L
- Iron
- Sulfide may cause turbidity
- Organic compounds like acetone above 0.1%, alcohols, aldehydes, aliphatic and aromatic amines, chloramines, glycine, or urea above 10 mg/L, to remove the interference distillation is required

10.2. AMMONIA MEDIUM RANGE

SPECIFICATIONS

Range	0.00 to 10.00 mg/L (as NH ₃ -N)
Resolution	0.01 mg/L
Accuracy	±0.05 mg/L ±5% of reading at 25 °C
Light Source	LED with narrow band interference filter @ 420 nm
Method	Adaptation of the ASTM Manual of Water and Environmental Technology, D1426, Nessler Method

REQUIRED REAGENTS

Code	Description	Quantity
HI93715A-0	Ammonia Medium Range Reagent A	4 drops
HI93715B-0	Ammonia Medium Range Reagent B	4 drops

REAGENT SETS

HI93715-01	Reagents for 100 tests
HI93715-03	Reagents for 300 tests

For other accessories see ACCESSORIES section.

MEASUREMENT PROCEDURE

- Select the **Ammonia MR** method using the procedure described in the METHOD SELECTION section.

- Fill the cuvette with 10 mL of unreacted sample (up to the mark).
Replace the plastic stopper and the cap.



- Insert the cuvette into the holder and close the lid.

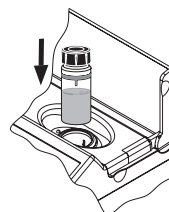

- Press **Zero**. The display will show “-0.0-” when the meter is zeroed and ready for measurement.

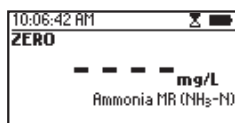
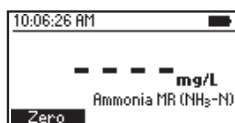

- Remove the cuvette.

- Add 4 drops of **HI93715A-0** Ammonia Medium Range Reagent A. Replace the plastic stopper and the cap. Swirl to mix the solution.

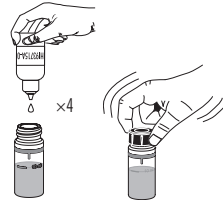

- Add 4 drops of **HI93715B-0** Ammonia Medium Range Reagent B. Replace the plastic stopper and the cap. Swirl to mix the solution.

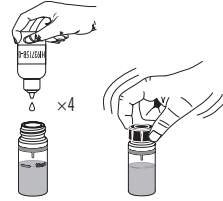

- Insert the cuvette into the holder and close the lid.

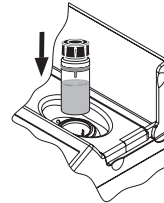

- Press **Timer** and the display will show the countdown prior to the measurement or wait 3 minutes and 30 seconds and press **Read**. When the timer ends the meter will perform the reading. The instrument displays the results in **mg/L of ammonia nitrogen (NH₃-N)**.

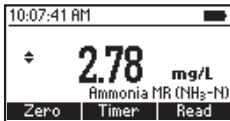
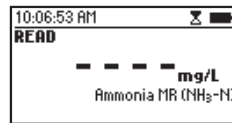
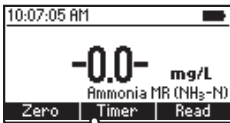

- Press the ▲ or ▼ key to access the second level functions.

- Press **Chem Frm** to convert the result to mg/L of ammonia (NH_3) and ammonium (NH_4^+).

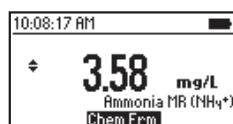
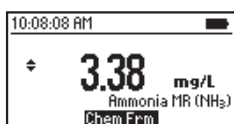
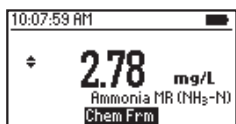

- Press the ▲ or ▼ key to return to the measurement screen.

INTERFERENCES

Interference may be caused by:

- Hardness above 1 g/L
- Iron
- Sulfide may cause turbidity
- Organic compounds like acetone above 0.1%, alcohols, aldehydes, aliphatic and aromatic amines, chloramines, glycine, or urea above 10 mg/L, to remove the interference distillation is required

10.3. AMMONIA HIGH RANGE

SPECIFICATIONS

Range	0.0 to 100.0 mg/L (as NH ₃ -N)
Resolution	0.1 mg/L
Accuracy	±0.5 mg/L ±5% of reading at 25 °C
Light Source	LED with narrow band interference filter @ 420 nm
Method	Adaptation of the ASTM Manual of Water and Environmental Technology, D1426, Nessler Method

REQUIRED REAGENTS

Code	Description	Quantity
HI93733A-0	Ammonia High Range Reagent A	4 drops
HI93733B-0	Ammonia High Range Reagent B	9 mL

REAGENT SETS

HI93733-01 Reagents for 100 tests

HI93733-03 Reagents for 300 tests

For other accessories see ACCESSORIES section.

MEASUREMENT PROCEDURE

- Select the **Ammonia HR** method using the procedure described in the METHOD SELECTION section.
- Add 1 mL of unreacted sample to the cuvette using a 1 mL syringe.
- Use the pipette to fill the cuvette up to the 10 mL mark with **HI93733B-0** Ammonia High Range Reagent B. Replace the plastic stopper and the cap. Swirl to mix the solution.
- Insert the cuvette into the holder and close the lid.

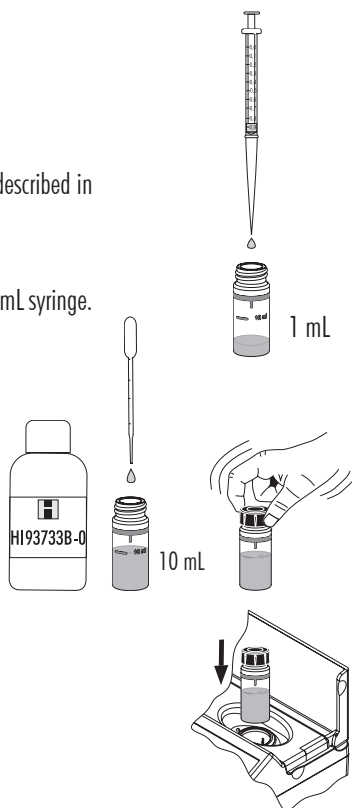

- Press **Zero**. The display will show “-0.0-” when the meter is zeroed and ready for measurement.

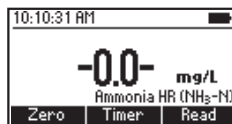
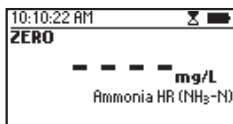
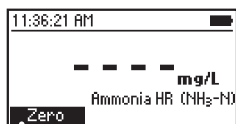

- Remove the cuvette.

- Add 4 drops of **HI93733A-0** Ammonia High Range Reagent A. Replace the plastic stopper and the cap. Swirl to mix the solution.

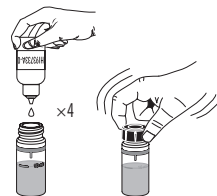

- Insert the cuvette into the holder and close the lid.

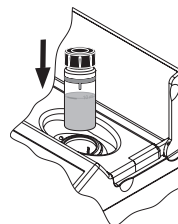

- Press **Timer** and the display will show the countdown prior to the measurement or wait 3 minutes and 30 seconds and press **Read**. When the timer ends the meter will perform the reading. The instrument displays the results in **mg/L** of ammonia nitrogen (**NH₃-N**).

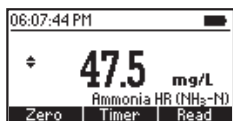
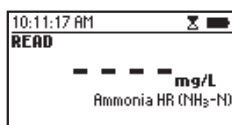
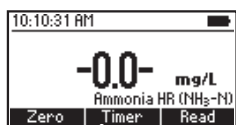

- Press the ▲ or ▼ key to access the second level functions.

- Press **Chem Frm** to convert the result to **mg/L** of ammonia (NH_3) and ammonium (NH_4^+).

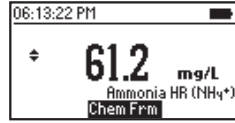
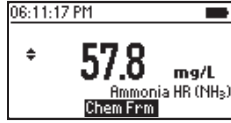
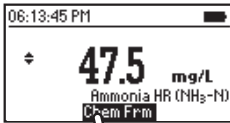

- Press the **▲** or **▼** key to return to the measurement screen.

INTERFERENCES

Interference may be caused by:

- Hardness above 1 g/L
- Iron
- Sulfide may cause turbidity
- Organic compounds like acetone above 0.1%, alcohols, aldehydes, aliphatic and aromatic amines, chloramines, glycine, or urea above 10 mg/L, to remove the interference distillation is required

10.4. CHLORINE, FREE

SPECIFICATIONS

Range	0.00 to 5.00 mg/L (as Cl ₂)
Resolution	0.01 mg/L
Accuracy	± 0.03 mg/L ± 3% of reading at 25 °C
Light Source	LED with narrow band interference filter @ 525 nm
Method	Adaptation of the EPA DPD Method 330.5

REQUIRED REAGENTS

POWDER

Code	Description	Quantity
HI93701-0	Free Chlorine Reagent	1 packet

LIQUID

Code	Description	Quantity
HI93701A-F	Free Chlorine Reagent A	3 drops
HI93701B-F	Free Chlorine Reagent B	3 drops

REAGENT SETS

HI93701-F	Reagents for 300 tests (liquid)
HI93701-01	Reagents for 100 tests (powder)
HI93701-03	Reagents for 300 tests (powder)

For other accessories see ACCESSORIES section.

MEASUREMENT PROCEDURE

- Select the **Chlorine (Free)** method using the procedure described in the METHOD SELECTION section.

- Fill the cuvette with 10 mL of unreacted sample (up to the mark).
Replace the plastic stopper and the cap.



- Insert the cuvette into the holder and close the lid.

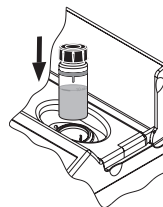

- Press **Zero**. The display will show “-0.0-” when the meter is zeroed and ready for measurement.

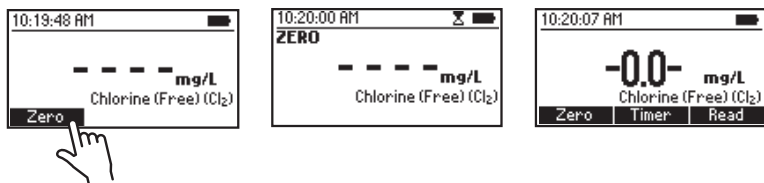

- Remove the cuvette.

POWDER REAGENT PROCEDURE

- Add the content of one packet of **HI93701-0** Free Chlorine Reagent. Replace the plastic stopper and the cap. Shake gently for 20 seconds.

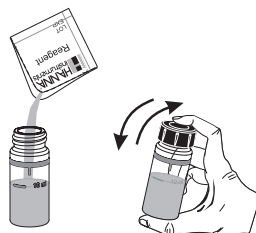

- Insert the cuvette into the holder and close the lid.

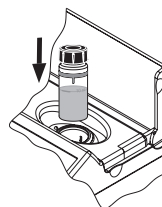

- Press **Timer** and the display will show the countdown prior to the measurement or wait 1 minute and press **Read**. When the timer ends the meter will perform the reading. The instrument displays the results in **mg/L of chlorine (Cl₂)**.

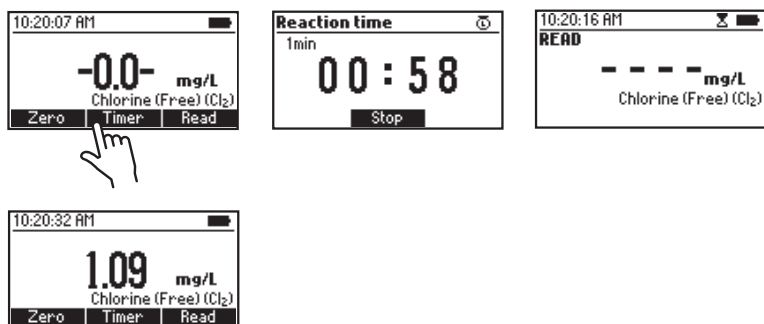

LIQUID REAGENT PROCEDURE

- To an empty cuvette add 3 drops of HI93701A-F Free Chlorine Reagent A and 3 drops of HI93701B-F Free Chlorine Reagent B.

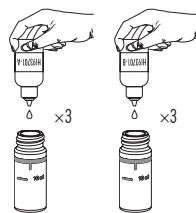

- Replace the plastic stopper and the cap. Swirl gently to mix.

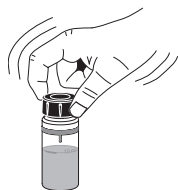

- Add 10 mL of unreacted sample (up to the mark). Replace the plastic stopper and the cap. Shake gently.



- Insert the cuvette into the holder and close the lid.

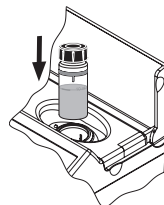

- Press **Read** to start the reading. The instrument displays the results in mg/L of chlorine (Cl_2).

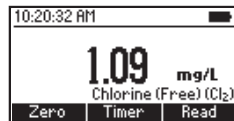
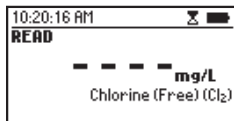
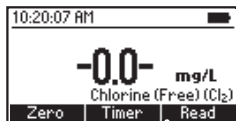

Note: Free and Total Chlorine have to be measured separately with fresh sample following the related procedure if both values are desired.

INTERFERENCES

Interference may be caused by:

- Bromine, Iodine, Oxidized forms of Chromium and Manganese, Ozone
- Hardness greater than 500 mg/L CaCO_3 , to remove the interference shake the sample for approximately 2 minutes after adding the powder reagent
- Alkalinity greater than 250 mg/L CaCO_3 or acidity value greater than 150 mg/L CaCO_3 , the color of the sample may develop only partially or rapidly fade, to remove the interference neutralize the sample with diluted HCl or NaOH

10.5. CHLORINE, TOTAL

SPECIFICATIONS

Range	0.00 to 5.00 mg/L (as Cl ₂)
Resolution	0.01 mg/L
Accuracy	±0.03 mg/L ± 3% of reading at 25 °C
Light Source	LED with narrow band interference filter @ 525 nm
Method	Adaptation of the EPA DPD Method 330.5

REQUIRED REAGENTS

POWDER

Code	Description	Quantity
HI93711-0	Total Chlorine Reagent	1 packet

LIQUID

Code	Description	Quantity
HI93701A-T	Total Chlorine Reagent A	3 drops
HI93701B-T	Total Chlorine Reagent B	3 drops
HI93701C-T	Total Chlorine Reagent C	1 drop

REAGENT SETS

HI93701-T	Reagents for 300 tests (liquid)
HI93711-01	Reagents for 100 total tests (powder)
HI93711-03	Reagents for 300 total tests (powder)

For other accessories see ACCESSORIES section.

MEASUREMENT PROCEDURE

- Select the **Chlorine (Total)** method using the procedure described in the **METHOD SELECTION** section.

- Fill the cuvette with 10 mL of unreacted sample (up to the mark).
Replace the plastic stopper and the cap.



- Insert the cuvette into the holder and close the lid.

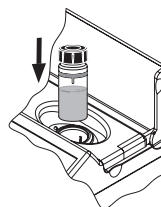

- Press **Zero**. The display will show “-0.0-” when the meter is zeroed and ready for measurement.

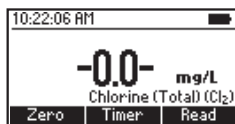
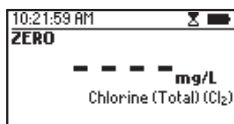
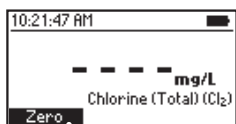

- Remove the cuvette.

POWDER REAGENT PROCEDURE

- Add 1 packet of **HI93711-0** Total Chlorine Reagent. Replace the plastic stopper and the cap. Shake gently for 20 seconds.

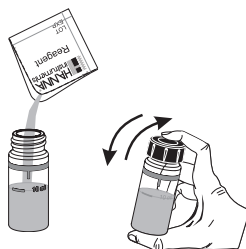

- Insert the cuvette into the holder and close the lid.

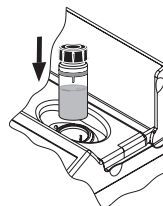

- Press **Timer** and the display will show the countdown prior to the measurement or wait 2 minutes and 30 seconds and press **Read**. When the timer ends the meter will perform the reading. The instrument displays the results in **mg/L** of chlorine (Cl_2).

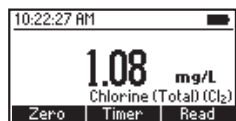
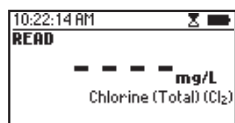
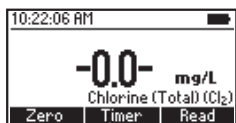

LIQUID REAGENT PROCEDURE

- To an empty cuvette add 3 drops of HI93701A-T Total Chlorine Reagent A, 3 drops of HI93701B-T Total Chlorine Reagent B and 1 drop of HI93701C-T Total Chlorine Reagent C.

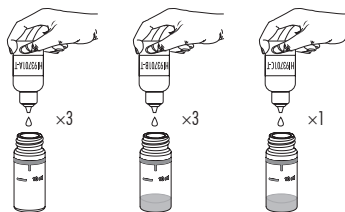

- Replace the plastic stopper and the cap. Swirl gently to mix.



- Add 10 mL of unreacted sample (up to the mark). Replace the plastic stopper and the cap. Shake gently.



10 mL



- Insert the cuvette into the holder and close the lid.

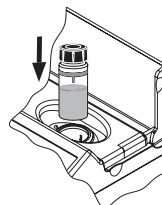

- Press **Timer** and the display will show the countdown prior to the measurement or wait 2 minutes and 30 seconds and press **Read**. When the timer ends the meter will perform the reading. The instrument displays the results in mg/L of chlorine (Cl_2).

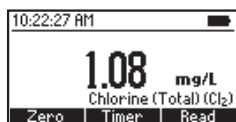
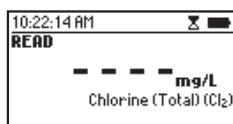
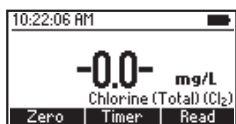

Note: Free and Total Chlorine have to be measured separately with fresh unreacted samples following the related procedure if both values are desired.

INTERFERENCES

Interference may be caused by:

- Bromine, Iodine, Oxidized forms of Chromium and Manganese, Ozone
- Hardness greater than 500 mg/L CaCO_3 , to remove the interference shake the sample for approximately 2 minutes after adding the powder reagent
- Alkalinity greater than 250 mg/L CaCO_3 or acidity greater than 150 mg/L CaCO_3 , the color of the sample may develop only partially or may rapidly fade, to remove the interference neutralize the sample with diluted HCl or NaOH

10.6. COPPER LOW RANGE

SPECIFICATIONS

Range	0.000 to 1.500 mg/L (as Cu ²⁺)
Resolution	0.001 mg/L
Accuracy	±0.010 mg/L ±5% of reading at 25 °C
Light Source	LED with narrow band interference filter @ 575 nm
Method	Adaptation of the EPA Method

REQUIRED REAGENTS

Code	Description	Quantity
HI95747-0	Copper Low Range Reagent	1 packet

REAGENT SETS

HI95747-01 Reagents for 100 tests

HI95747-03 Reagents for 300 tests

For other accessories see ACCESSORIES section.

MEASUREMENT PROCEDURE

- Select the **Copper LR** method using the procedure described in the METHOD SELECTION section.

- Fill the cuvette with 10 mL of unreacted sample (up to the mark).
Replace the plastic stopper and the cap.



- Insert the cuvette into the holder and close the lid.

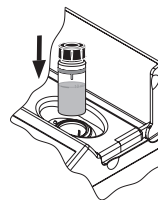

- Press **Zero**. The display will show “-0.0-” when the meter is zeroed and ready for measurement.

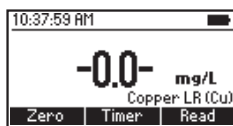
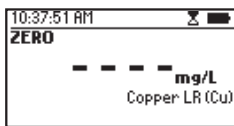
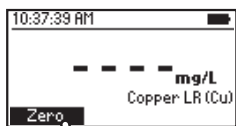

- Remove the cuvette.
- Add one packet of **HI95747-0** Copper Low Range Reagent. Replace the plastic stopper and the cap. Shake gently for about 15 seconds.

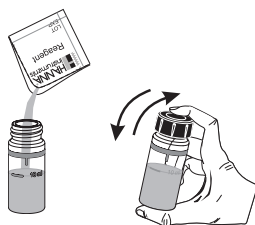

- Insert the cuvette into the holder and close the lid.

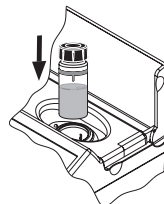

- Press **Timer** and the display will show the countdown prior to the measurement or wait 45 seconds and press **Read**. When the timer ends the meter will perform the reading. The instrument displays the results in **mg/L of copper (Cu)**.

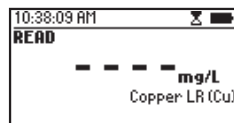
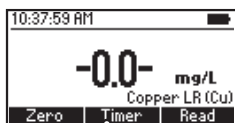

INTERFERENCES

Interference may be caused by:

- Cyanide, Silver
- For samples overcoming buffering capacity of reagent around pH 6.8, pH should be adjusted between 6 and 8

10.7. COPPER HIGH RANGE

SPECIFICATIONS

Range	0.00 to 5.00 mg/L (as Cu ²⁺)
Resolution	0.01 mg/L
Accuracy	±0.02 mg/L ±4% of reading at 25 °C
Light Source	LED with narrow band interference filter @ 575 nm
Method	Adaptation of the EPA Method

REQUIRED REAGENTS

Code	Description	Quantity
HI93702-0	Copper High Range Reagent	1 packet

REAGENT SETS

HI93702-01 Reagents for 100 tests

HI93702-03 Reagents for 300 tests

For other accessories see ACCESSORIES section.

MEASUREMENT PROCEDURE

- Select the **Copper HR** method using the procedure described in the METHOD SELECTION section.

- Fill the cuvette with 10 mL of unreacted sample (up to the mark).
Replace the plastic stopper and the cap.



- Insert the cuvette into the holder and close the lid.

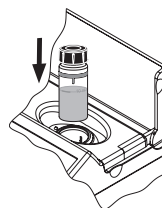

- Press **Zero**. The display will show “-0.0-” when the meter is zeroed and ready for measurement.

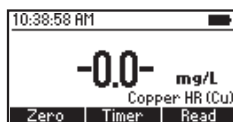
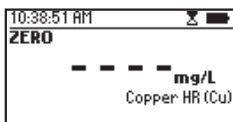
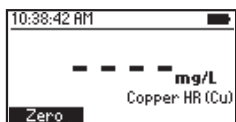

- Remove the cuvette.
- Add one packet of **HI93702-0** Copper High Range Reagent. Replace the plastic stopper and the cap. Shake gently for about 15 seconds.

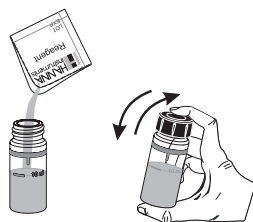

- Insert the cuvette into the holder and close the lid.

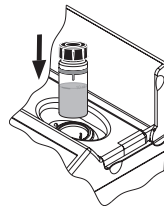

- Press **Timer** and the display will show the countdown prior to the measurement or wait 45 seconds and press **Read**. When the timer ends the meter will perform the reading. The instrument displays the results in **mg/L of copper (Cu)**.

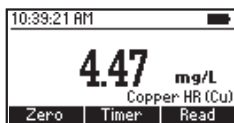
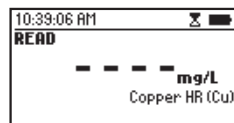
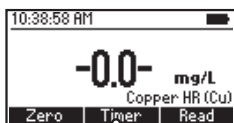

INTERFERENCES

Interference may be caused by:

- Cyanide, Silver
- For samples overcoming buffering capacity of reagent around pH 6.8, pH should be adjusted between 6 and 8

10.8. FLUORIDE LOW RANGE

SPECIFICATIONS

Range	0.00 to 2.00 mg/L (as F ⁻)
Resolution	0.01 mg/L
Accuracy	±0.03 mg/L ± 3% of reading at 25 °C
Light Source	LED with narrow band interference filter @ 575 nm
Method	Adaptation of Standard Methods for the Examination of Water and Wastewater, 18 th Edition, SPADNS Method

REQUIRED REAGENT

Code	Description	Quantity
HI93729-0	Fluoride Low Range Reagent	4 mL

REAGENT SETS

HI93729-01 Reagents for 100 tests

HI93729-03 Reagents for 300 tests

For other accessories see ACCESSORIES section.

MEASUREMENT PROCEDURE

- Select the **Fluoride LR** method using the procedure described in the METHOD SELECTION section.
- Add 2 mL of **HI93729-0** Fluoride Low Range Reagent to two cuvettes.
- Use a plastic pipette to fill one cuvette with 10 mL of deionized water (up to the mark) (#1). Replace the plastic stopper and the cap. Invert several times to mix.
- Use a plastic pipette to fill the second cuvette with 10 mL of unreacted sample (up to the mark) (#2). Replace the plastic stopper and the cap. Invert several times to mix.
- Insert the first cuvette (#1) into the holder and close the lid.

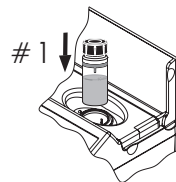
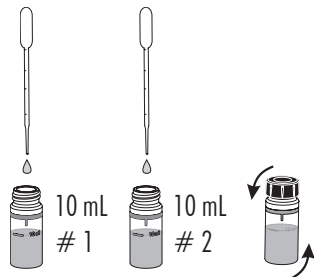
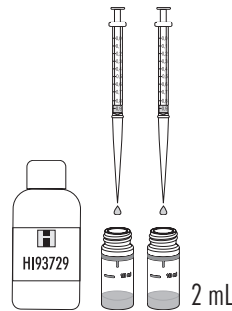

- Press **Timer** and the display will show the countdown prior to zeroing the blank or wait 2 minutes and press **Zero**. The display will show “-0.0-” when the meter is zeroed and ready for measurement.

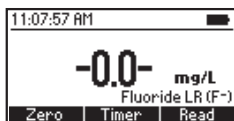
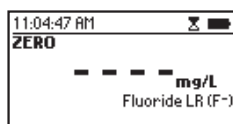
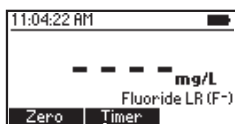

- Remove the cuvette.
- Insert the second cuvette (#2) with the reacted sample into the holder and close the lid.
- Press **Read** to start reading. The instrument displays the results in **mg/L of fluoride (F⁻)**.

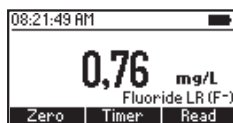
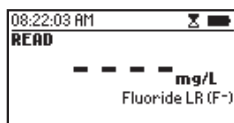
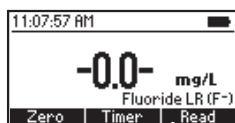
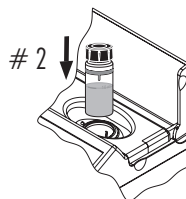

Note: For wastewater or seawater samples, before performing measurements, distillation is required. For most accurate results use two graduated pipettes to deliver exactly 8 mL of deionized water and 8 mL of sample.

INTERFERENCES

Interference may be caused by:

- Alkalinity above 5000 mg/L CaCO₃
- Chloride above 700 mg/L
- Sulfate above 200 mg/L
- Orthophosphate above 16 mg/L
- Iron (Ferric) above 10 mg/L
- Sodium hexametaphosphate above 1.0 mg/L
- Aluminum above 0.1 mg/L
- Highly colored and turbid samples may require distillation
- Highly alkaline samples can be neutralized with nitric acid

10.9. IRON LOW RANGE

SPECIFICATIONS

Range	0.000 to 1.600 mg/L (as Fe)
Resolution	0.001 mg/L
Accuracy	± 0.010 mg/L $\pm 8\%$ of reading at 25 °C
Light Source	LED with narrow band interference filter @ 575 nm
Method	Adaptation of the TPTZ Method

REQUIRED REAGENTS

Code	Description	Quantity
HI93746-0	Iron Low Range Reagent	2 packets

REAGENT SETS

HI93746-01	Reagents for 50 tests
HI93746-03	Reagents for 150 tests

For other accessories see ACCESSORIES section.

MEASUREMENT PROCEDURE

- Select the **Iron LR** method using the procedure described in the **METHOD SELECTION** section.

- Fill one graduated mixing cylinder up to the 25 mL mark with deionized water.

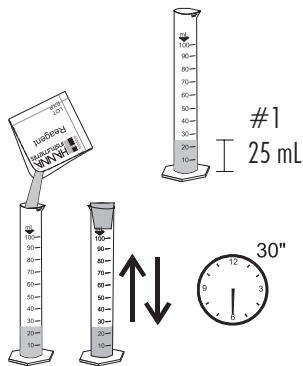

- Add one packet of **HI93746-0** Iron Low Range Reagent, close the cylinder and shake vigorously for 30 seconds. This is the blank.

- Fill a cuvette with 10 mL of the blank (up to the mark). Replace the rubber stopper.

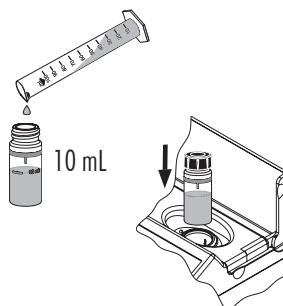

- Insert the cuvette into the holder and close the lid.

- Press **Zero**. The display will show “-0.0-” when the meter is zeroed and ready for measurement.

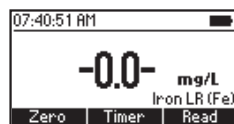
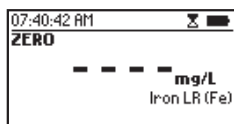
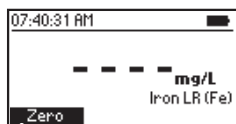

- Remove the cuvette.
- Fill another graduated mixing cylinder up to the 25 mL mark with the sample.

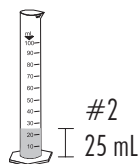

- Add one packet of **HI93746-0** Iron Low Range Reagent, close the cylinder and shake vigorously for 30 seconds. This is the reacted sample.

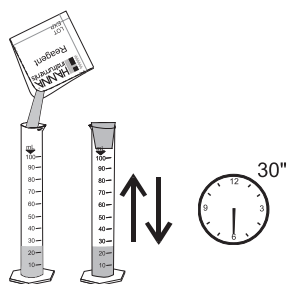

- Fill a cuvette with 10 mL of the reacted sample (up to the mark). Replace the rubber stopper.



- Insert the sample into the holder and close the lid.

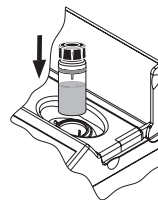

- Press **Timer** and the display will show the countdown prior to the measurement or wait 30 seconds and press **Read**. When the timer ends the meter will perform the reading. The instrument displays concentration in **mg/L of iron (Fe)**.

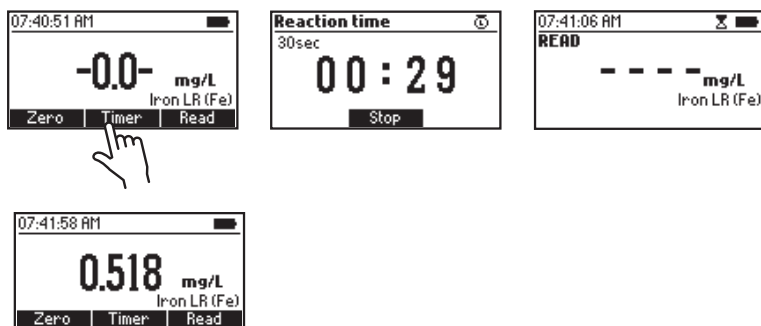

INTERFERENCES

Interference may be caused by:

- Manganese above 50.0 mg/L
- Cadmium, Molybdenum above 4.0 mg/L
- Cyanide above 2.8 mg/L
- Chromium(VI) above 1.2 mg/L
- Nickel above 1.0 mg/L
- Nitrite ion above 0.8 mg/L
- Copper above 0.6 mg/L
- Mercury above 0.4 mg/L
- Chromium(III) above 0.25 mg/L
- Cobalt above 0.05 mg/L
- Sample pH should be between 3 and 4 to avoid fading or turbidity formation

10.10. IRON HIGH RANGE

SPECIFICATIONS

Range	0.00 to 5.00 mg/L (as Fe)
Resolution	0.01 mg/L
Accuracy	± 0.04 mg/L $\pm 2\%$ of reading at 25 °C
Light Source	LED with narrow band interference filter @ 525 nm
Method	Adaptation of Standard Methods for the Examination of Water and Wastewater, 23 rd Edition, 3500-Fe B, Phenanthroline Method

REQUIRED REAGENTS

Code	Description	Quantity
HI93721-0	Iron High Range Reagent	1 packet

REAGENT SETS

HI93721-01 Reagents for 100 tests

HI93721-03 Reagents for 300 tests

For other accessories see ACCESSORIES section.

MEASUREMENT PROCEDURE

- Select the **Iron HR** method using the procedure described in the METHOD SELECTION section.

- Fill the cuvette with 10 mL of unreacted sample (up to the mark).
Replace the plastic stopper and the cap.

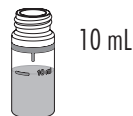

- Insert the cuvette into the holder and close the lid.

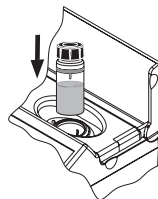

- Press **Zero**. The display will show “-0.0-” the meter is zeroed and ready for measurement.

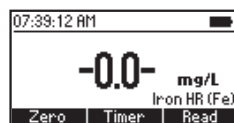
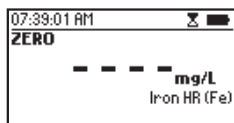
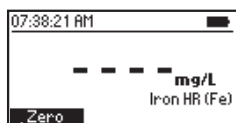

- Remove the cuvette and add the content of one packet of **HI93721-0 Iron High Range Reagent**. Replace the plastic stopper and the cap. Shake until powder is completely dissolved.

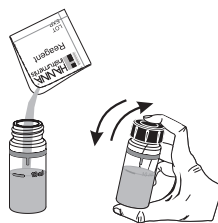

- Insert the cuvette into the holder and close the lid.

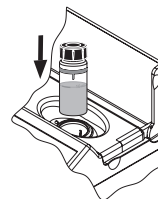

- Press **Timer** and the display will show the countdown prior to the measurement or wait 3 minutes and press **Read**. When the timer ends the meter will perform the reading. The instrument displays the result in **mg/L of iron (Fe)**.

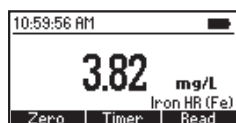
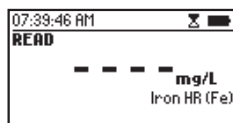
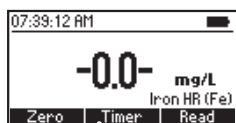

INTERFERENCES

Interference may be caused by:

- Chloride above 185000 mg/L
- Magnesium above 100000 mg/L CaCO_3
- Calcium above 10000 mg/L CaCO_3
- Molybdate Molybdenum above 50 mg/L

10.11. MANGANESE LOW RANGE

SPECIFICATIONS

Range	0 to 300 $\mu\text{g/L}$ (as Mn)
Resolution	1 $\mu\text{g/L}$
Accuracy	$\pm 10 \mu\text{g/L} \pm 3\%$ of reading at 25 °C
Light Source	LED with narrow band interference filter @ 575 nm
Method	Adaptation of the PAN Method

REQUIRED REAGENTS

Code	Description	Quantity
HI93748A-0	Manganese Low Range Reagent A	2 packets
HI93748B-0	Manganese Low Range Reagent B	0.40 mL
HI93748C-0	Manganese Low Range Reagent C	2 mL
HI93703-51	Dispersing Agent	6 drops

REAGENT SETS

HI93748-01 Reagents for 50 tests

HI93748-03 Reagents for 150 tests

For other accessories see ACCESSORIES section.

MEASUREMENT PROCEDURE

- Select the **Manganese LR** method using the procedure described in the METHOD SELECTION section.

- Fill one cuvette (#1) with 10 mL of deionized water (up to the mark).

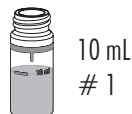

- Fill a second cuvette (#2) with 10 mL of sample (up to the mark).



- Add one packet of HI93748A-0 Manganese Low Range Reagent A to each cuvette. Replace the plastic stoppers and the caps. Shake gently until completely dissolved.

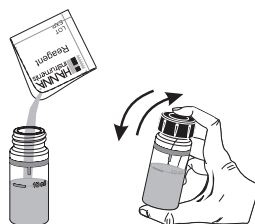

- Add 0.2 mL of the **HI93748B-0** Manganese Low Range Reagent B to each cuvette. Replace the plastic stoppers and the caps. Invert gently to mix for about 30 seconds.

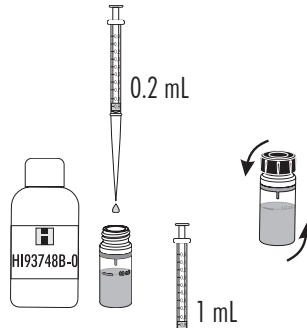

- Add 1 mL of the **HI93748C-0** Manganese Low Range Reagent C to each cuvette, replace the plastic stoppers and the caps. Shake gently.

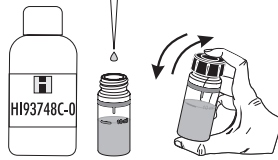

- Add 3 drops of **HI93703-51** Dispersing Agent to each cuvette. Replace the plastic stoppers and the caps. Invert gently to mix for about 30 seconds.

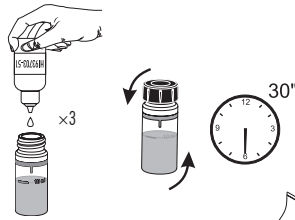

- Insert the first cuvette (#1) with the reacted deionized water into the holder and close the lid.

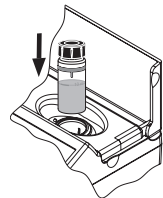

- Press **Timer** and the display will show the countdown prior to zeroing the blank or wait 2 minutes and then press **Zero**. The display will show "-0.0-" when the meter is zeroed and ready for measurement.

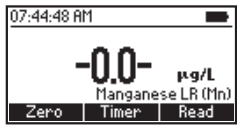
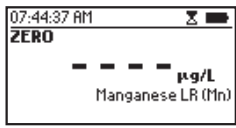
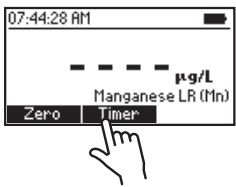

- Insert the second cuvette (#2) with the reacted sample into the holder and close the lid.

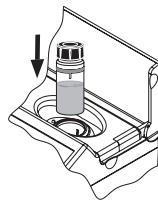

- Press **Read** to start the reading. The instrument displays the results in $\mu\text{g/L}$ of manganese (Mn).

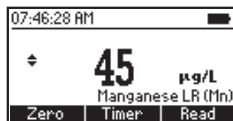
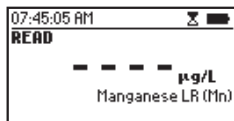

- Press the \blacktriangle or \blacktriangledown key to access the second level functions.
- Press **Chem Frm** to convert the result to $\mu\text{g/L}$ of potassium permanganate (KMnO_4) and permanganate (MnO_4^-).

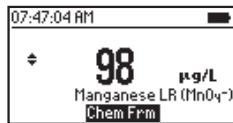
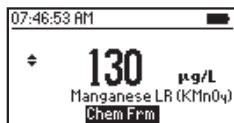
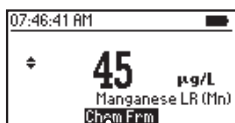

- Press the \blacktriangle or \blacktriangledown key to return to the measurement screen.

INTERFERENCES

Interference may be caused by:

- Calcium above 200 mg/L CaCO_3
- Magnesium above 100 mg/L CaCO_3
- Copper above 50 mg/L
- Nickel above 40 mg/L
- Aluminum, Cobalt above 20 mg/L
- Zinc above 15 mg/L
- Cadmium, Iron above 10 mg/L
- Lead above 0.5 mg/L

10.12. MANGANESE HIGH RANGE

SPECIFICATIONS

Range	0.0 to 20.0 mg/L (as Mn)
Resolution	0.1 mg/L
Accuracy	± 0.2 mg/L $\pm 3\%$ of reading at 25 °C
Light Source	LED with narrow band interference filter @ 525 nm
Method	Adaptation of Standard Methods for the Examination of Water and Wastewater, 18 th Edition, Periodate Method

REQUIRED REAGENTS

Code	Description	Quantity
HI93709A-0	Manganese High Range Reagent A	1 packet
HI93709B-0	Manganese High Range Reagent B	1 packet

REAGENT SETS

HI93709-01 Reagents for 100 tests

HI93709-03 Reagents for 300 tests

For other accessories see ACCESSORIES section.

MEASUREMENT PROCEDURE

- Select the **Manganese HR** method using the procedure described in the METHOD SELECTION section.
- Fill the cuvette with 10 mL of unreacted sample (up to the mark).
Replace the plastic stopper and the cap.
- Insert the cuvette into the holder and close the lid.
- Press **Zero**. The display will show “-0.0-” when the meter is zeroed and ready for measurement.

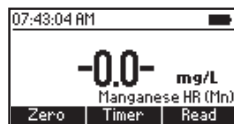
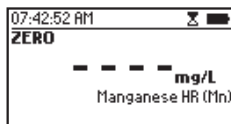
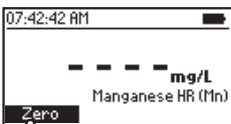
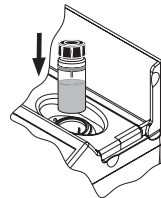
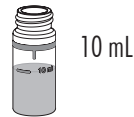

- Remove the cuvette.

- Add one packet of **HI93709A-0** Manganese High Range Reagent A. Replace the plastic stopper and the cap. Shake gently for 2 minutes to mix.

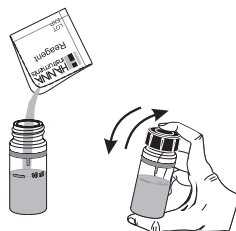

- Add one packet of **HI93709B-0** Manganese High Range Reagent B. Replace the plastic stopper and the cap. Shake gently for 2 minutes to mix.

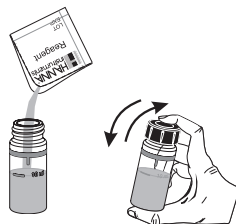

- Insert the cuvette into the holder and close the lid.

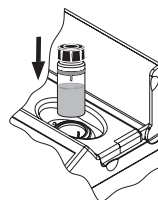

- Press **Timer** and the display will show the countdown prior to the measurement or wait 1 minute and 30 seconds and press **Read**. When the timer ends the meter will perform the reading. The instrument displays the results in **mg/L of manganese (Mn)**.

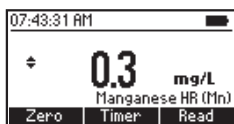
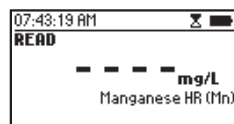
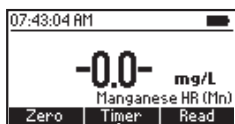

- Press the **▲** or **▼** key to access the second level functions.

- Press **Chem Frm** to convert the result to mg/L potassium permanganate (KMnO_4) and permanganate (MnO_4^-).

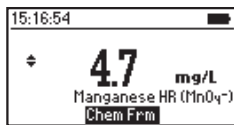
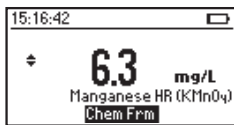
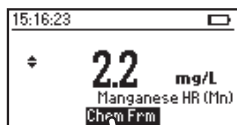

- Press the ▲ or ▼ key to return to the measurement screen.

INTERFERENCES

Interference may be caused by:

- Magnesium above 100000 mg/L
- Chloride above 70000 mg/L
- Calcium above 700 mg/L
- Iron above 5 mg/L

10.13. MOLYBDENUM

SPECIFICATIONS

Range	0.0 to 40.0 mg/L (as Mo ⁶⁺)
Resolution	0.1 mg/L
Accuracy	±0.3 mg/L ±5% of reading at 25 °C
Light Source	LED with narrow band interference filter @ 420 nm
Method	Adaptation of the Mercaptoacetic Acid Method

REQUIRED REAGENTS

Code	Description	Quantity
HI93730A-0	Molybdenum Reagent A	1 packet
HI93730B-0	Molybdenum Reagent B	1 packet
HI93730C-0	Molybdenum Reagent C	1 packet

REAGENT SETS

HI93730-01	Reagents for 100 tests
HI93730-03	Reagents for 300 tests

For other accessories see ACCESSORIES section.

MEASUREMENT PROCEDURE

- Select the **Molybdenum** method using the procedure described in the METHOD SELECTION section.

- Fill the cuvette with 10 mL of unreacted sample (up to the mark).
Replace the plastic stopper and the cap.



- Insert the cuvette into the holder and close the lid.

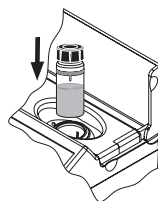

- Press **Zero**. The display will show “-0.0-” when the meter is zeroed and ready for measurement.

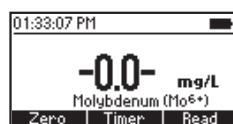
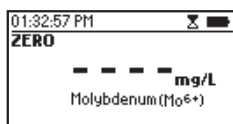
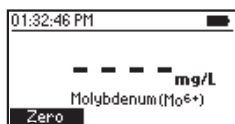

- Fill one graduated mixing cylinder up to the 25 mL mark with the sample.

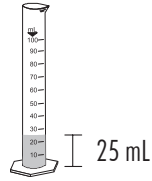

- Add one packet of **HI93730A-0** Molybdenum Reagent A to the cylinder, close and invert several times until completely dissolved.

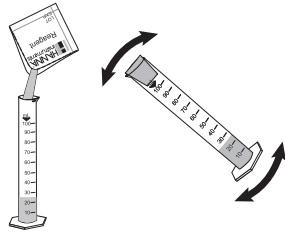

- Add one packet of **HI93730B-0** Molybdenum Reagent B to the cylinder, close and invert several times until completely dissolved.

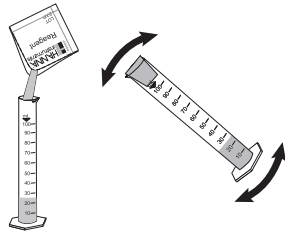

- Add one packet of **HI93730C-0** Molybdenum Reagent C to the cylinder, close and shake vigorously.

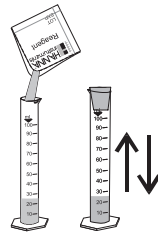

- Fill an empty cuvette with 10 mL of reacted sample (up to the mark). Replace the plastic stopper and the cap.



- Insert the cuvette into the holder and close the lid.

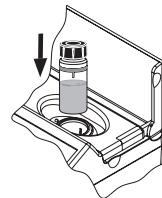

- Press **Timer** and the display will show the countdown prior to the measurement or wait 5 minutes and press **Read**. When the timer ends the meter will perform the reading. The instrument displays concentration in **mg/L** of **molybdenum (Mo^{6+})**.

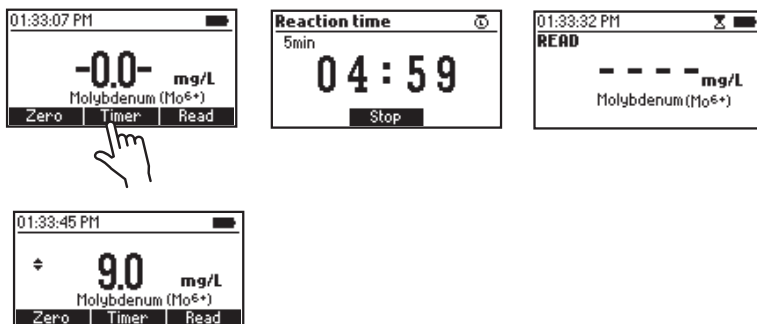

- Press the **▲** or **▼** key to access the second level functions.
- Press **Chem Frm** to convert the result to **mg/L** of **molybdate (MoO_4^{2-})** and **sodium molybdate (Na_2MoO_4)**.

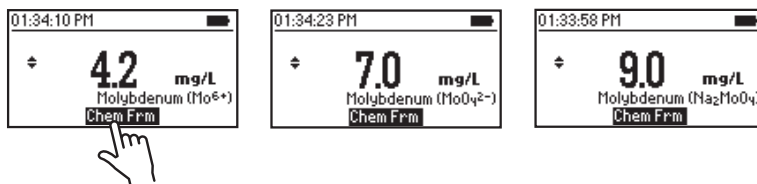

- Press the **▲** or **▼** key to return to the measurement screen.

INTERFERENCES

Interference may be caused by:

- Chromium above 1000 mg/L
- Sulfate above 200 mg/L
- Aluminum, Iron, Nickel above 50 mg/L
- Copper above 10 mg/L
- Nitrite must be absent
- Highly buffered samples or samples with extreme pH may exceed the buffering capacity of the reagents

10.14. NICKEL LOW RANGE

SPECIFICATIONS

Range	0.000 to 1.000 mg/L (as Ni)
Resolution	0.001 mg/L
Accuracy	±0.010 mg/L ±7% of reading at 25 °C
Light Source	LED with narrow band interference filter @ 575 nm
Method	Adaptation of the PAN Method

REQUIRED REAGENTS

Code	Description	Quantity
HI93740A-0	Nickel Low Range Reagent A	2 packets
HI93740B-0	Nickel Low Range Reagent B	2 mL
HI93740C-0	Nickel Low Range Reagent C	2 packets
HI93703-51	Dispersing Agent (optional reagent)	4-6 drops

REAGENT SETS

HI93740-01 Reagents for 50 tests

HI93740-03 Reagents for 150 tests

For other accessories see ACCESSORIES section.

MEASUREMENT PROCEDURE

- Select the **Nickel LR** method using the procedure described in the **METHOD SELECTION** section.

Note: For best results samples should be between 20 °C and 24 °C.

- Fill one graduated beaker with 25 mL of deionized water (blank) and another one with 25 mL of sample.

- Add one packet of **HI93740A-0** Nickel Low Range Reagent A to each beaker. Cap and swirl gently until the reagent is dissolved.

Note: If sample contains iron (Fe^{3+}), it is important that all powder is dissolved before continuing.

- Add 1 mL of **HI93740B-0** Nickel Low Range Reagent B to each beaker and swirl to mix.

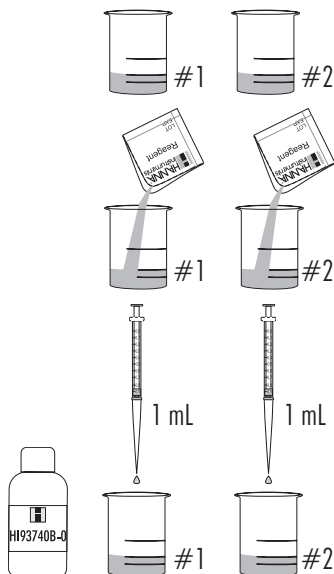

- Press **Timer** and the display will show a countdown or wait 15 minutes.

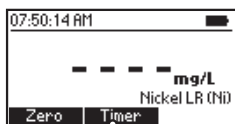

- Add one packet of **HI93740C-0** Nickel Low Range Reagent C to each beaker, cap and swirl to mix until completely dissolved.

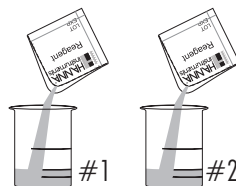

- Fill one cuvette (#1) with 10 mL of the blank (up to the mark). Replace the plastic stopper and the cap.

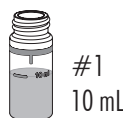

- Insert the cuvette into the holder and close the lid.

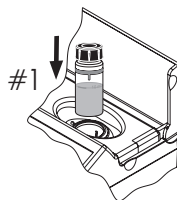

- Press **Zero**. The display will show “-0.0-” when the meter is zeroed and ready for measurement.

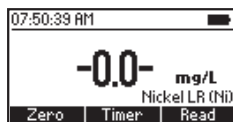
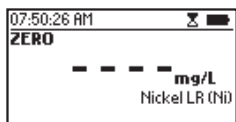
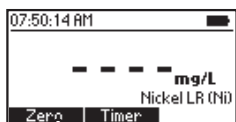

- Fill a second cuvette (#2) with 10 mL of the reacted sample (up to the mark). Replace the plastic stopper and the cap.



- Insert the second cuvette into the holder and close the lid.

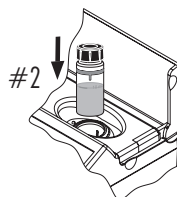

- Press **Read** to start the reading. The instrument displays the results in mg/L of nickel (Ni).

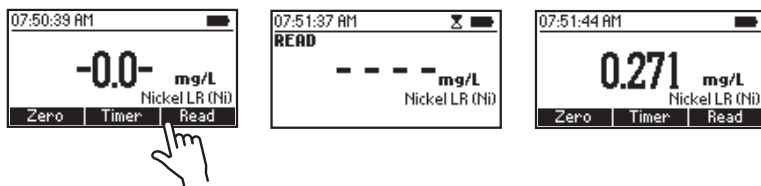

Note: A temperature above 30 °C may cause turbidity. In this case, add 2 to 3 drops of [HI93703-51](#) Dispersing Agent to each cuvette and swirl until turbidity is removed before zeroing the meter and reading the sample.

INTERFERENCES

Interference may be caused by:

- Chloride above 8000 mg/L
- Sodium above 5000 mg/L
- Calcium above 1000 mg/L CaCO₃
- Potassium above 500 mg/L
- Magnesium above 400 mg/L
- Molybdenum above 60 mg/L
- Chromium(VI) above 40 mg/L
- Aluminum above 32 mg/L
- Zinc above 30 mg/L
- Manganese above 25 mg/L
- Cadmium, Chromium(III), Fluoride, Lead above 20 mg/L
- Copper above 15 mg/L
- Iron (Ferric) above 10 mg/L
- Cobalt, Iron (Ferrous) must not be present

10.15. NICKEL HIGH RANGE

SPECIFICATIONS

Range	0.00 to 7.00 g/L (as Ni)
Resolution	0.01 g/L
Accuracy	$\pm 0.07\text{g/L} \pm 4\%$ of reading at 25 °C
Light Source	LED with narrow band interference filter @ 575 nm
Method	Adaptation of the Photometric Method

REQUIRED REAGENTS

Code	Description	Quantity
HI93726-0	Nickel High Range Reagent	1 packet

REAGENT SETS

HI93726-01 Reagents for 100 tests

HI93726-03 Reagents for 300 tests

For other accessories see ACCESSORIES section.

MEASUREMENT PROCEDURE

- Select the **Nickel HR** method using the procedure described in the METHOD SELECTION section.

- Fill the cuvette with 10 mL of unreacted sample (up to the mark).
Replace the plastic stopper and the cap.



- Insert the cuvette into the holder and close the lid.

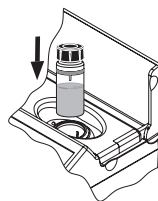

- Press **Zero**. The display will show “-0.0-” when the meter is zeroed and ready for measurement.

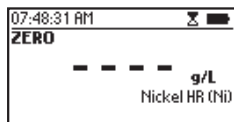
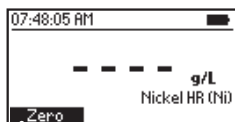

- Remove the cuvette and add one packet of **HI93726-0** Nickel High Range Reagent. Replace the plastic stopper and the cap. Shake gently until completely dissolved.

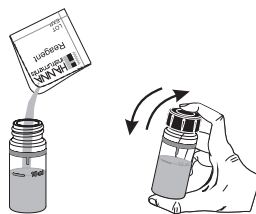

- Insert the cuvette into the holder and close the lid.

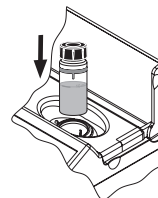

- Press **Timer** and the display will show the countdown prior to the measurement or wait 1 minute and press **Read**. When the timer ends the meter will perform the reading. The instrument displays the concentration in **g/L** of **nickel (Ni)**.

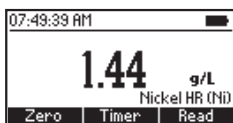
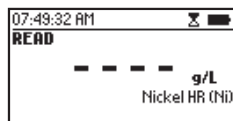

INTERFERENCES

Interference may be caused by:

- Copper

10.16. NITRATE

SPECIFICATIONS

Range	0.0 to 30.0 mg/L (as NO ₃ ⁻ - N)
Resolution	0.1 mg/L
Accuracy	±0.5 mg/L ±10% of reading at 25 °C
Light Source	LED with narrow band interference filter @ 525 nm
Method	Adaptation of the Cadmium Reduction Method

REQUIRED REAGENTS

Code	Description	Quantity
HI93728-0	Nitrate Reagent	1 packet

REAGENT SETS

HI93728-01 Reagents for 100 tests

HI93728-03 Reagents for 300 tests

For other accessories see ACCESSORIES section.

MEASUREMENT PROCEDURE

- Select the **Nitrate** method using the procedure described in the METHOD SELECTION section.

- Fill the cuvette with 10 mL of sample (up to the mark). Replace the plastic stopper and the cap.



10 mL

- Insert the cuvette into the holder and close the lid.

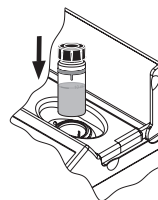

- Press **Zero**. The display will show “-0.0-” when the meter is zeroed and ready for measurement.

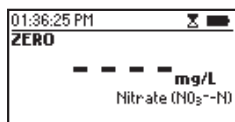
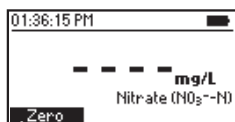

- Remove the cuvette and add one packet of HI93728-0 Nitrate Reagent.



- Replace the plastic stopper and the cap. Shake vigorously up and down for exactly 10 seconds. Continue to mix by inverting the cuvette gently for 50 seconds, while taking care not to induce air bubbles. Powder will not completely dissolve.

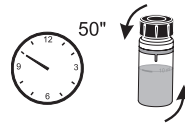
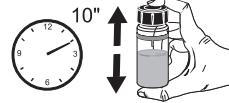

Note: The method is technique sensitive. See procedure described in CUVETTE PREPARATION section for proper mixing technique.

- Insert the cuvette into the holder and close the lid.

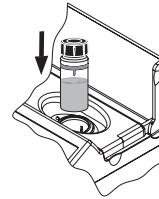

- Press **Timer** and the display will show the countdown prior to the measurement or wait 4 minutes and 30 seconds and press **Read**. When the timer ends the meter will perform the reading. The instrument displays the results in mg/L of nitrate-nitrogen (NO_3^- -N).

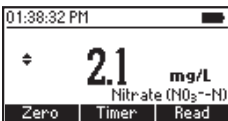
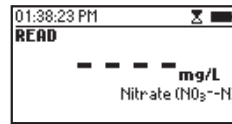
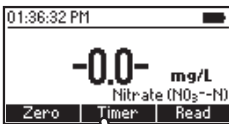

- Press the ▲ or ▼ key to access the second level functions.

- Press **Chem Frm** to convert the result to mg/L of nitrate (NO_3^-).

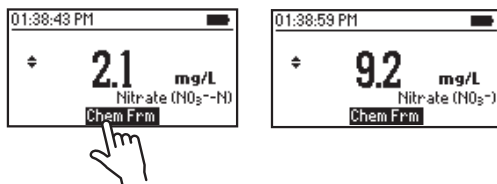

- Press the ▲ or ▼ key to return to the measurement screen.

INTERFERENCES

Interference may be caused by:

- Ammonia and amines, as urea and primary aliphatic amines
- Chloride above 100 mg/L
- Chlorine above 2 mg/L
- Copper, Iron (Ferric), Strong oxidizing and reducing substances
- Sulfide must be absent

10.17. OXYGEN, DISSOLVED

SPECIFICATIONS

Range	0.0 to 10.0 mg/L (as O ₂)
Resolution	0.1 mg/L
Accuracy	±0.4 mg/L ±3% of reading at 25 °C
Light Source	LED with narrow band interference filter @ 420 nm
Method	Adaptation of Standard Methods for the Examination of Water and Wastewater, 18 th Edition, Azide Modified Winkler Method

REQUIRED REAGENTS

Code	Description	Quantity
HI93732A-0	Dissolved Oxygen Reagent A	5 drops
HI93732B-0	Dissolved Oxygen Reagent B	5 drops
HI93732C-0	Dissolved Oxygen Reagent C	10 drops

REAGENT SET

HI93732-01 Reagents for 100 tests

HI93732-03 Reagents for 300 tests

For other accessories see ACCESSORIES section.

MEASUREMENT PROCEDURE

- Select the **Oxygen (Dissolved)** method using the procedure described in the **METHOD SELECTION** section.
- Fill one 60 mL glass bottle completely with the unreacted sample.
- Replace the cap and ensure that a small part of the sample spills over.
- Remove the cap and add 5 drops of **HI93732A-0** and 5 drops of **HI93732B-0**.

- Add more sample to fill the bottle completely. Replace the cap and ensure that a part of the sample spills over.

Note: This ensures no air bubbles have been trapped inside the bottle. Trapped air bubbles could alter readings.

- Invert the bottle several times until the sample turns orange-yellow and a flocculating agent appears.

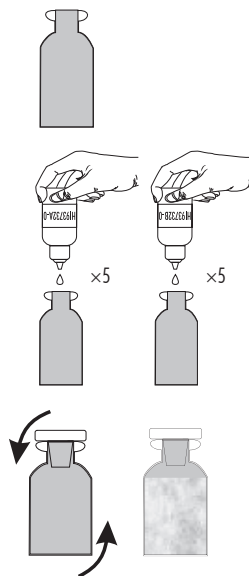

- Let the sample stand for approximately 2 minutes to allow flocculating agent to settle.
- When the upper half of the bottle is clear, add 10 drops of HI93732C-0 Dissolved Oxygen Reagent C.



- Replace the cap and invert the bottle until the settled flocculating agent dissolves completely. The sample is ready for measurement when it is yellow and completely clear.

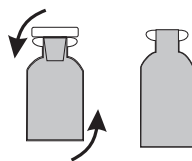

- Fill the first cuvette (#1) with 10 mL of the unreacted sample (up to the mark). Replace the plastic stopper and the cap.



- Insert the cuvette into the holder and close the lid.

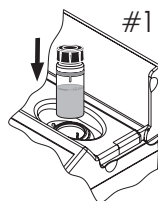

- Press **Zero**. The display will show “-0.0-” when the meter is zeroed and ready for measurement.

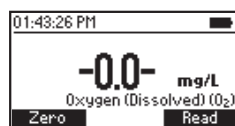
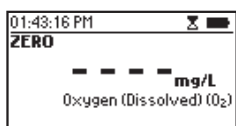
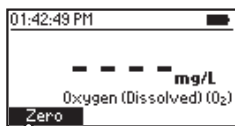

- Remove the cuvette.
- Fill second cuvette (#2) with 10 mL of the reacted sample (up to the mark). Replace the plastic stopper and the cap.



- Insert the cuvette into the holder and close the lid.

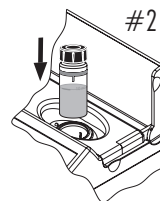

- Press **Read** to start the reading. The instrument will display the results in **mg/L** of oxygen (O_2).

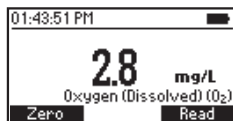
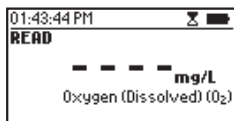
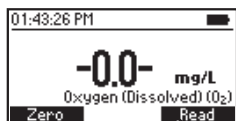

INTERFERENCES

Interference may be caused by:

- Reducing and oxidizing materials

10.18. pH

SPECIFICATIONS

Range	6.5 to 8.5 pH
Resolution	0.1 pH
Accuracy	± 0.1 pH at 25 °C
Light Source	LED with narrow band interference filter @ 525 nm
Method	Adaptation of the Phenol Red Method

REQUIRED REAGENTS

Code	Description	Quantity
HI93710-0	pH Reagent	5 drops

REAGENT SETS

HI93710-01 Reagents for 100 tests

HI93710-03 Reagents for 300 tests

For other accessories see ACCESSORIES section.

MEASUREMENT PROCEDURE

- Select the pH method using the procedure described in the METHOD SELECTION section.

- Fill the cuvette with 10 mL of unreacted sample (up to the mark).
Replace the plastic stopper and the cap.



- Insert the cuvette into the holder and close the lid.

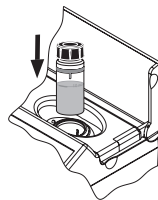

- Press **Zero**. The display will show “-0.0-” when the meter is zeroed and ready for measurement.

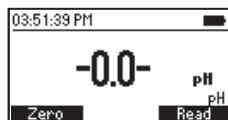
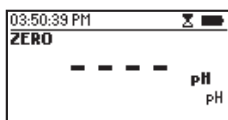
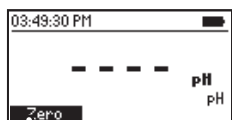

- Remove the cuvette and add 5 drops of HI93710-0 pH Reagent Indicator. Replace the plastic stopper and the cap and mix the solution.

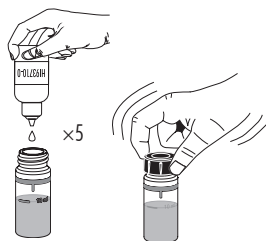

- Insert the cuvette into the holder and close the lid.

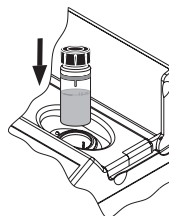

- Press **Read** to start the reading. The instrument displays the result in pH.

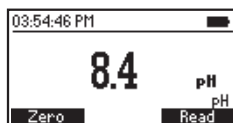
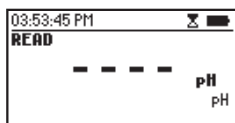

10.19. PHOSPHATE LOW RANGE

SPECIFICATIONS

Range	0.00 to 2.50 mg/L (as PO_4^{3-})
Resolution	0.01 mg/L
Accuracy	± 0.04 mg/L $\pm 4\%$ of reading at 25 °C
Light Source	LED with narrow band interference filter @ 610 nm
Method	Adaptation of the Ascorbic Acid Method

REQUIRED REAGENTS

Code	Description	Quantity
HI93713-0	Phosphate Low Range Reagent	1 packet

REAGENT SETS

HI93713-01 Reagents for 100 tests

HI93713-03 Reagents for 300 tests

For other accessories see ACCESSORIES section.

MEASUREMENT PROCEDURE

- Select the **Phosphate LR** method using the procedure described in the METHOD SELECTION section.
- Rinse and replace the plastic stopper and the cap. Shake the cuvette several times with unreacted sample.
- Fill the cuvette with 10 mL of sample (up to the mark). Replace the plastic stopper and the cap.
- Insert the cuvette into the holder and close the lid.
- Press **Zero**. The display will show “-0.0-” when the meter is zeroed and ready for measurement.

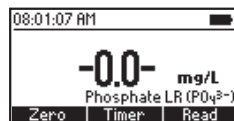
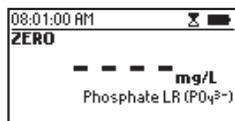
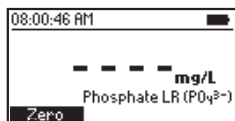
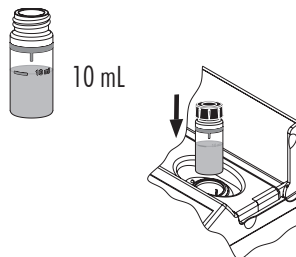

- Remove the cuvette and add the content of one packet of HI93713-0 Phosphate Low Range Reagent. Replace the plastic stopper and the cap. Shake gently (for about 2 minutes) until the powder is completely dissolved.

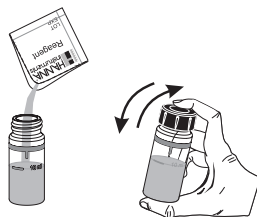

- Insert the cuvette into the holder and close the lid.

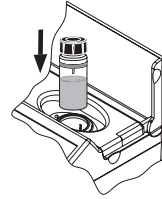

- Press **Timer** and the display will show the countdown prior to the measurement or wait 3 minutes and press **Read**. When the timer ends the meter will perform the reading. The instrument displays concentration in mg/L of phosphate (PO_4^{3-}).

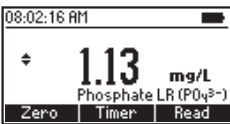
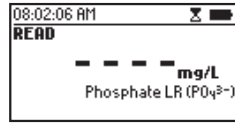
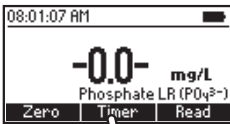

- Press the ▲ or ▼ key to access the second level functions.
- Press **Chem Frm** to convert the result to mg/L of phosphorus (P) and phosphorus pentoxide (P_2O_5).

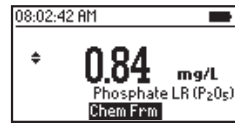
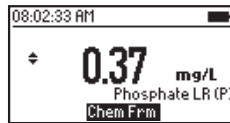
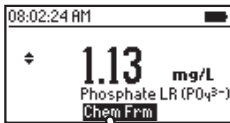

- Press the ▲ or ▼ key to return to the measurement screen.

INTERFERENCES

Interference may be caused by:

- Iron, Silica above 50 mg/L
- Copper, Silicate above 10 mg/L
- Arsenate, Highly buffered samples, Hydrogen sulfide, Turbid samples

10.20. PHOSPHATE HIGH RANGE

SPECIFICATIONS

Range	0.0 to 30.0 mg/L (as PO_4^{3-})
Resolution	0.1 mg/L
Accuracy	± 1.0 mg/L $\pm 4\%$ of reading at 25 °C
Light Source	LED with narrow band interference filter @ 525 nm
Method	Adaptation of Standard Methods for the Examination of Water and Wastewater, 18 th Edition, Amino Acid Method

REQUIRED REAGENTS

Code	Description	Quantity
HI93717A-0	Phosphate High Range Reagent A	10 drops
HI93717B-0	Phosphate High Range Reagent B	1 packet

REAGENT SETS

HI93717-01 Reagents for 100 tests

HI93717-03 Reagents for 300 tests

For other accessories see ACCESSORIES section.

MEASUREMENT PROCEDURE

- Select the **Phosphate HR** method using the procedure described in the METHOD SELECTION section.

- Fill the cuvette with 10 mL of unreacted sample (up to the mark).
Replace the plastic stopper and the cap.



- Insert the cuvette into the holder and close the lid.

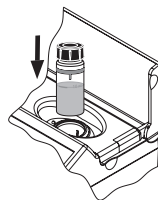

- Press **Zero**. The display will show “-0.0-” when the meter is zeroed and ready for measurement.

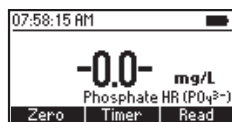
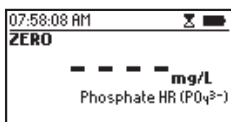
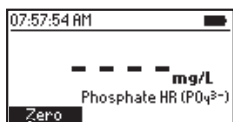

- Add 10 drops of HI93717A-0 Phosphate HR Reagent A.

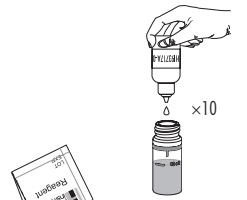

- Add one packet of HI93717B-0 Phosphate HR Reagent B to the cuvette. Replace the plastic stopper and the cap. Shake gently until completely dissolved.

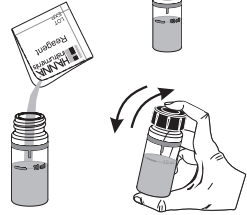

- Insert the cuvette into the holder and close the lid.

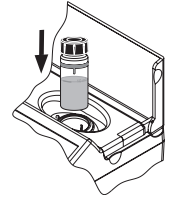

- Press **Timer** and the display will show the countdown prior to the measurement or wait 5 minutes and press **Read**. When the timer ends the meter will perform the reading. The instrument displays the results in **mg/L of phosphate (PO_4^{3-})**.

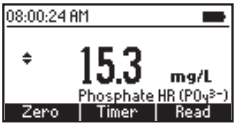
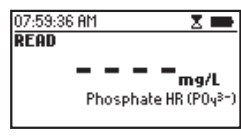
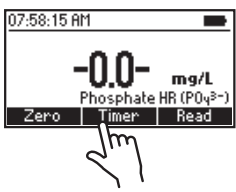

- Press the ▲ or ▼ key to access the second level functions.
- Press **Chem Frm** to convert the result to **mg/L of phosphorus (P)** and **phosphorus pentoxide (P_2O_5)**.

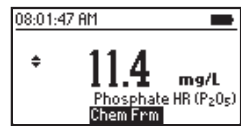
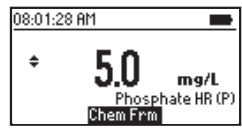
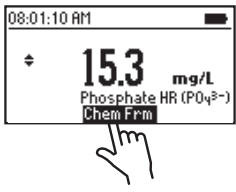

- Press the ▲ or ▼ key to return to the measurement screen.

INTERFERENCES

Interference may be caused by:

- Sulfide
- Chloride above 150000 mg/L
- Magnesium above 40000 mg/L CaCO₃
- Calcium above 10000 mg/L CaCO₃
- Iron (Ferrous) above 100 mg/L

10.21. SILICA LOW RANGE

SPECIFICATIONS

Range	0.00 to 2.00 mg/L (as SiO ₂)
Resolution	0.01 mg/L
Accuracy	±0.03 mg/L ± 3% of reading at 25 °C
Light Source	LED with narrow band interference filter @ 610 nm
Method	Adaptation of the ASTM Manual of Water and Environmental Technology, D859, Heteropoly Molybdenum Blue Method

REQUIRED REAGENTS

Code	Description	Quantity
HI93705A-0	Silica Low Range Reagent A	6 drops
HI93705B-0	Silica Low Range Reagent B	1 packet
HI93705C-0	Silica Low Range Reagent C	1 packet

REAGENT SETS

HI93705-01 Reagents for 100 tests

HI93705-03 Reagents for 300 tests

For other accessories see ACCESSORIES section.

MEASUREMENT PROCEDURE

- Select the **Silica LR** method using the procedure described in the **METHOD SELECTION** section.

- Fill the cuvette with 10 mL of unreacted sample (up to the mark).



- Add 6 drops of **HI93705A-0** Silica LR Reagent A. Replace the plastic stopper and the cap. Swirl the solution.

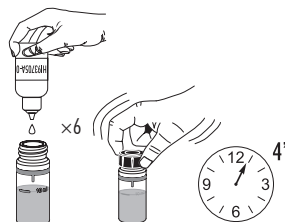

- Press **Timer** and the display will show the countdown prior to adding **HI93705B-0** Silica LR Reagent B or wait 4 minutes.

- Add one packet of **HI93705B-0** Silica LR Reagent B and shake until it is completely dissolved.

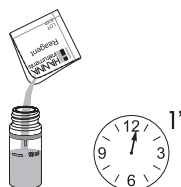

- Press **Continue** and the display will show the countdown or wait 1 minute.

- Insert the cuvette into the holder and close the lid.

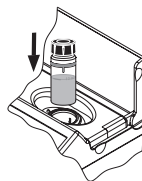

- Press **Zero**. The display will show “-0.0-” when the meter is zeroed and ready for measurement.

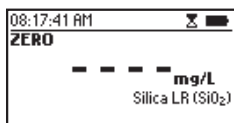
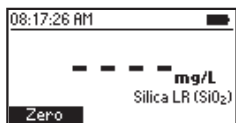

- Remove the cuvette.
- Add one packet of **HI93705C-0** Silica LR Reagent C and shake until it is completely dissolved.



- Insert the cuvette into the holder and close the lid.

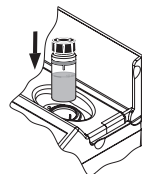

- Press **Timer** and the display will show the countdown prior to the measurement or wait 3 minutes and press **Read**. When the timer ends the meter will perform the reading. The instrument displays result in **mg/L of silica (SiO₂)**.

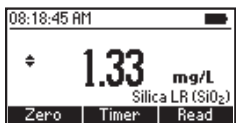
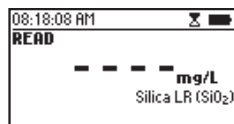

- Press the **▲** or **▼** key to access the second level functions.

- Press **Chem Frm** to convert the result to mg/L of silicon (Si).



- Press the ▲ or ▼ key to return to the measurement screen.

INTERFERENCES

Interference may be caused by:

- Phosphate above 75 mg/L, causes an 11% reduction in reading
- Phosphate above 60 mg/L, causes a 2% reduction in reading
- Sulfide and high concentration of iron
- Eliminate color and turbidity interferences by zeroing the meter with the original water sample

10.22. SILVER

SPECIFICATIONS

Range	0.000 to 1.000 mg/L (as Ag)
Resolution	0.001 mg/L
Accuracy	± 0.020 mg/L $\pm 5\%$ of reading at 25 °C
Light Source	LED with narrow band interference filter @ 575 nm
Method	Adaptation of the PAN Method

REQUIRED REAGENTS

Code	Description	Quantity
HI93737A-0	Silver Reagent A	1 mL
HI93737B-0	Silver Reagent B	1 mL
HI93737C-0	Silver Reagent C	2 mL
HI93737D-0	Silver Reagent D	2 mL
HI93703-51	Dispersing Agent	6 drops

REAGENT SETS

HI93737-01	Reagents for 50 tests
HI93737-03	Reagents for 150 tests

For other accessories see ACCESSORIES section.

Note: For best results perform the tests between 20 °C and 24 °C.

MEASUREMENT PROCEDURE

- Select the **Silver** method using the procedure described in the METHOD SELECTION section.

- Fill two graduated beakers with 25 mL of sample.

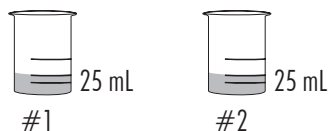

- Add 1 mL of **HI93737A-0** Silver Reagent A to beaker #1 (the blank) and swirl gently to mix.

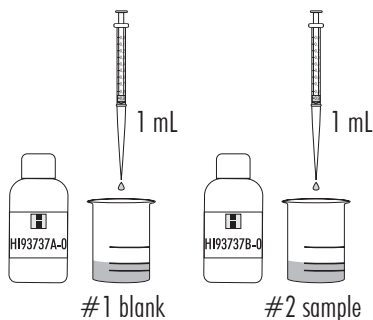

- Add 1 mL of **HI93737B-0** Silver Reagent B to beaker #2 (the sample) and swirl gently to mix.

- Press **Timer** and the display will show the countdown prior to adding HI93737C-0 Silver Reagent C or wait 2 minutes.

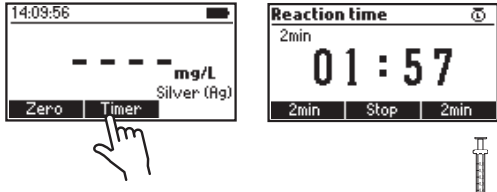

- Add 1 mL of HI93737C-0 Silver Reagent C to each beaker and swirl.

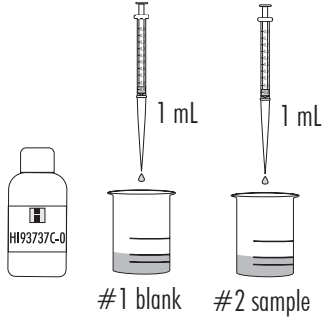

- Press **Continue** and the display will show the countdown prior to adding HI93737D-0 Silver Reagent D or wait 2 minutes.

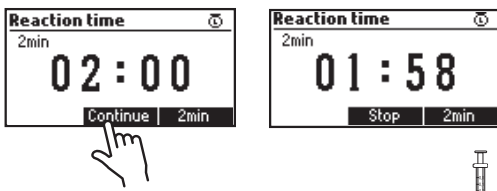

- Add 1 mL of HI93737D-0 Silver Reagent D to each beaker and swirl.

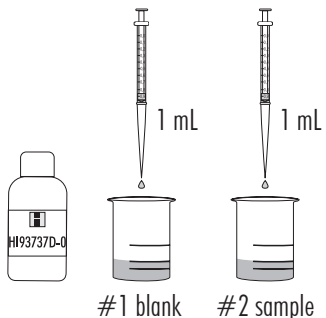

- Press **Continue** and the display will show the countdown or wait 2 minutes.

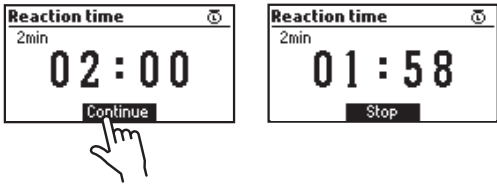

- Fill cuvette (#1) up with 10 mL of the blank (up to the mark).



- Add 3 drops of [HI93703-51](#) Dispersing Agent, replace the plastic stopper and the cap. Invert gently for 10 seconds.

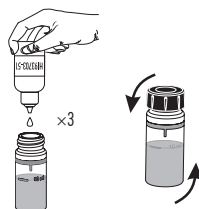

- Insert the cuvette into the holder and close the lid.

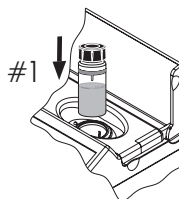

- Press **Zero**. The display will show "-0.0-" when the meter is zeroed and ready for measurement.

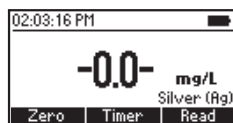
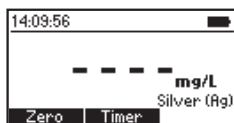

- Fill a second cuvette (#2) up with 10 mL of the reacted sample (up to the mark).

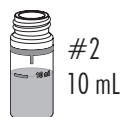

- Add 3 drops of [HI93703-51](#) Dispersing Agent, replace the plastic stopper and the cap. Invert gently for 10 seconds.

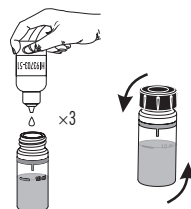

- Insert the second cuvette (#2) into the holder and close the lid.

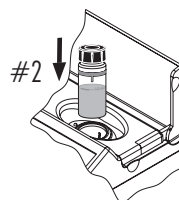

- Press **Read** to start the reading. The instrument displays the results in mg/L of silver (Ag).

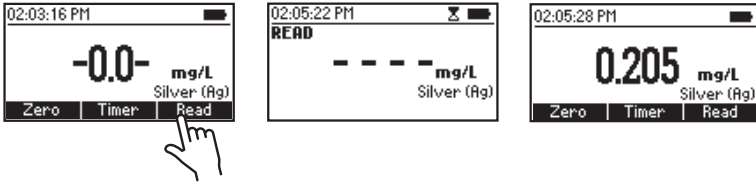

INTERFERENCES

Interference may be caused by:

- Chloride above 8000 mg/L
- Sodium above 5000 mg/L
- Calcium, Magnesium above 1000 mg/L CaCO_3
- Potassium above 500 mg/L
- Aluminum, Zinc above 30 mg/L
- Chromium(VI) above 40 mg/L
- Manganese above 25 mg/L
- Cadmium, Chromium(III), Fluoride, Lead above 20 mg/L
- Copper above 15 mg/L
- Iron (Ferric) above 10 mg/L
- Cobalt, Iron (Ferrous), Nickel above 1.5 mg/L

10.23. ZINC

SPECIFICATIONS

Range	0.00 to 3.00 mg/L (as Zn)
Resolution	0.01 mg/L
Accuracy	± 0.03 mg/L $\pm 3\%$ of reading at 25 °C
Light Source	LED with narrow band interference filter @ 575 nm
Method	Adaptation of Standard Methods for the Examination of Water and Wastewater, 18 th Edition, Zincon Method

REQUIRED REAGENT

Code	Description	Quantity
HI93731A-0	Zinc Reagent A	1 packet
HI93731B-0	Zinc Reagent B	0.5 mL

REAGENT SETS

HI93731-01 Reagents for 100 tests

HI93731-03 Reagents for 300 tests

For other accessories see ACCESSORIES section.

MEASUREMENT PROCEDURE

- Select the **Zinc** method using the procedure described in the METHOD SELECTION section.

- Fill the graduated glass vial up to the 20 mL mark with the sample.

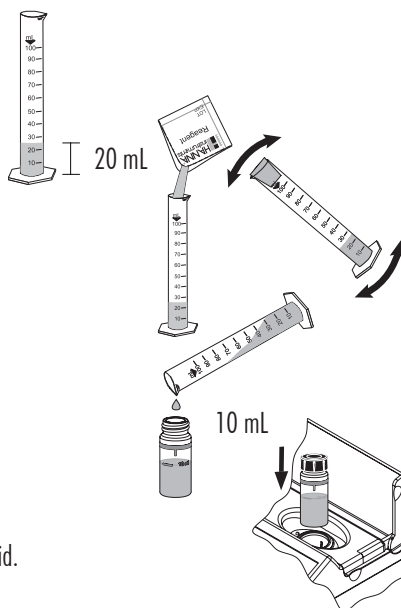

- Add one packet of **HI93731A-0** Zinc Reagent A, close the cylinder. Invert several times to mix until completely dissolved.

- Fill a cuvette with 10 mL of the reacted sample (up to the mark). Replace the plastic stopper and the cap.

- Insert the cuvette into the holder and close the lid.

- Press **Zero**. The display will show “-0.0-” when the meter is zeroed and ready for measurement.

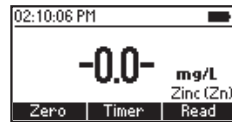
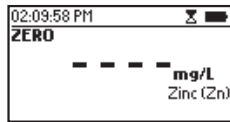
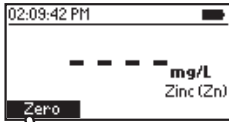

- Add 0.5 mL of **HI93731B-0** Zinc Reagent B to the cuvette. Replace the plastic stopper and the cap. Swirl gently for 15 seconds.

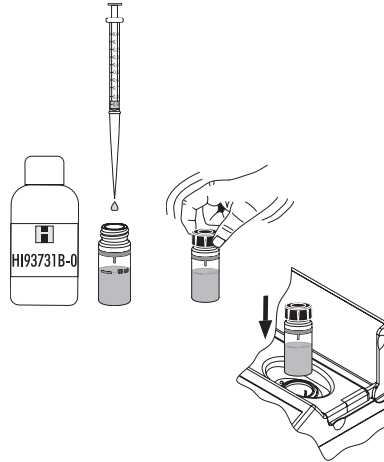

- Insert the sample into the instrument and close the lid.

- Press **Timer** and the display will show the countdown prior to the measurement or wait 3 minutes and 30 seconds and press **Read**. When the timer ends the meter will perform the reading. The instrument displays the results in **mg/L of zinc (Zn)**.

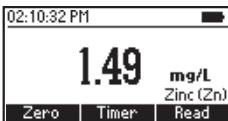
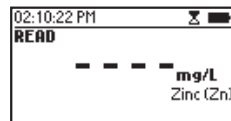
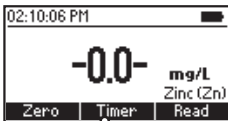

INTERFERENCES

Interference may be caused by:

- Iron above 7 mg/L
- Aluminum above 6 mg/L
- Copper, Manganese, Nickel above 5 mg/L
- Cadmium above 0.5 mg/L

11. WARNINGS & ERRORS

The instrument shows clear warning messages when erroneous conditions appear and when measured values are outside the expected range. The information below provides an explanation of the errors and warnings, and recommended action to be taken.

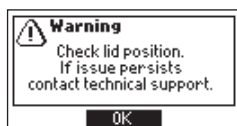

There is an excess amount of ambient light reaching the detector. Make sure the lid is closed before performing any measurements. If the issue persists, please contact Hanna Instruments technical support.



The sample and the zero cuvettes are inverted. Swap the cuvettes and repeat the measurement.

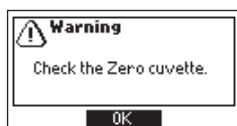

There is either too much light or the instrument can not adjust the light level. Please check the preparation of the zero cuvette and that the sample does not contain any debris.



The meter is either overheating or its temperature has dropped too low to operate within published accuracy specifications. The meter must be between 0 and 50 °C (32 and 122 °F) to perform any measurements.



Meter temperature has changed significantly since the zero measurement has been performed. The zero measurement must be performed again.

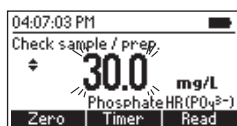

The measured value is outside the limits of the method. If possible, change the method range. Verify that the sample does not contain any debris. Check the sample preparation and the measurement preparation.

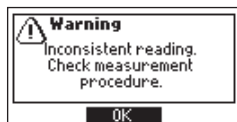

The measured value cannot be calculated.
Please check sample preparation and measurement procedure.



Stored results of the CAL Check measurements have been lost.
Please redo the CAL Check measurements to ensure accurate results.



User settings have been lost.
Please reset the values. If the issue persists, please contact Hanna Instruments technical support.



Flash drive is not recognized or it might be damaged.
Please insert a new USB flash drive.



Data log is full.
Please review logged data and delete unnecessary logs.



Date and time settings have been lost.
Please reset the values. If the issue persists, please contact Hanna Instruments technical support.

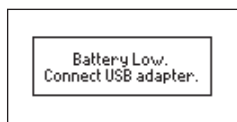

Battery level is too low to ensure normal functioning and the meter will turn off.
Connect the USB adapter to charge the battery.

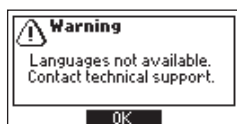

English is the only available language. Some features are no longer available.
Restart the meter. If the issue persists, please contact Hanna Instruments technical support.

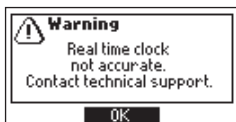

Real time clock is not accurate. Some features are no longer available. Restart the meter. If the issue persists, please contact Hanna Instruments technical support.

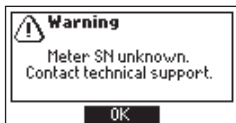

The device serial number can not be identified. Some features are no longer available. Restart the meter. If the issue persists, please contact Hanna Instruments technical support.



Logged data is no longer accessible. Some features are no longer available. Restart the meter. If the issue persists, please contact Hanna Instruments technical support.



Battery charge level is not accurate. Some features are no longer available. Restart the meter. If the issue persists, please contact Hanna Instruments technical support.

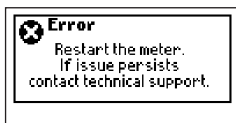

A critical error has occurred. Restart the meter. If the issue persists, please contact Hanna Instruments technical support.

12. STANDARD METHODS

Description	Range	Method
Ammonia LR	0.00 to 3.00 mg/L (as $\text{NH}_3\text{-N}$)	Nessler
Ammonia MR	0.00 to 10.00 mg/L (as $\text{NH}_3\text{-N}$)	Nessler
Ammonia HR	0.0 to 100.0 mg/L (as $\text{NH}_3\text{-N}$)	Nessler
Chlorine, Free	0.00 to 5.00 mg/L (as Cl_2)	DPD
Chlorine, Total	0.00 to 5.00 mg/L (as Cl_2)	DPD
Copper LR	0.000 to 1.500 mg/L (as Cu^{2+})	Bicinchoninate
Copper HR	0.00 to 5.00 mg/L (as Cu^{2+})	Bicinchoninate
Fluoride LR	0.00 to 2.00 mg/L (as F ⁻)	SPADNS
Iron LR	0.000 to 1.600 mg/L (as Fe)	TPTZ
Iron HR	0.00 to 5.00 mg/L (as Fe)	Phenanthroline
Manganese LR	0 to 300 $\mu\text{g/L}$ (as Mn)	PAN
Manganese HR	0.0 to 20.0 mg/L (as Mn)	Periodate
Molybdenum	0.0 to 40.0 mg/L (as Mo^{6+})	Mercaptoacetic Acid
Nickel LR	0.000 to 1.000 mg/L (as Ni)	PAN
Nickel HR	0.00 to 7.00 g/L (as Ni)	Colorimetric
Nitrate	0.0 to 30.0 mg/L (as NO_3^- - N)	Cadmium reduction
Oxygen, Dissolved	0.0 to 10.0 mg/L (as O_2)	Winkler
pH	6.5 to 8.5 pH	Phenol Red
Phosphate LR	0.00 to 2.50 mg/L (as PO_4^{3-})	Ascorbic Acid
Phosphate HR	0.0 to 30.0 mg/L (as PO_4^{3-})	Amino Acid
Silica LR	0.00 to 2.00 mg/L (as SiO_2)	Heteropoly Blue
Silver	0.000 to 1.000 mg/L (as Ag)	PAN
Zinc	0.00 to 3.00 mg/L (as Zn)	Zincon

13. ACCESSORIES

13.1. REAGENT SETS

Code	Description
HI93700-01	100 ammonia LR tests
HI93700-03	300 ammonia LR tests
HI93701-01	100 chlorine free tests (powder)
HI93701-03	300 chlorine free tests (powder)
HI93701-F	300 chlorine free tests (liquid)
HI93701-T	300 chlorine total tests (liquid)
HI93702-01	100 copper HR tests
HI93702-03	300 copper HR tests
HI93705-01	100 silica LR tests
HI93705-03	300 silica LR tests
HI93709-01	100 manganese HR tests
HI93709-03	300 manganese HR tests
HI93710-01	100 pH tests
HI93710-03	300 pH tests
HI93711-01	100 chlorine total tests (powder)
HI93711-03	300 chlorine total tests (powder)
HI93713-01	100 phosphate LR tests
HI93713-03	300 phosphate LR tests
HI93715-01	100 ammonia MR tests
HI93715-03	300 ammonia MR tests
HI93717-01	100 phosphate HR tests
HI93717-03	300 phosphate HR tests
HI93721-01	100 iron HR tests
HI93721-03	300 iron HR tests

Code	Description
HI93726-01	100 nickel HR tests
HI93726-03	300 nickel HR tests
HI93728-01	100 nitrate tests
HI93728-03	300 nitrate tests
HI93729-01	100 fluoride LR tests
HI93729-03	300 fluoride LR tests
HI93730-01	100 molybdenum tests
HI93730-03	300 molybdenum tests
HI93731-01	100 zinc tests
HI93731-03	300 zinc tests
HI93732-01	100 dissolved oxygen tests
HI93732-03	300 dissolved oxygen tests
HI93733-01	100 ammonia HR tests
HI93733-03	300 ammonia HR tests
HI93737-01	50 silver tests
HI93737-03	150 silver tests
HI93740-01	50 nickel LR tests
HI93740-03	150 nickel LR tests
HI93746-01	50 iron LR tests
HI93746-03	150 iron LR tests
HI93748-01	50 manganese LR tests
HI93748-03	150 manganese LR tests
HI95747-01	100 copper LR tests
HI95747-03	300 copper LR tests

13.2. pH ELECTRODES

Code	Description
HI10530	Triple ceramic, double junction, low temperature glass, refillable pH electrode with conical tip and temperature sensor
HI10430	Triple ceramic, double junction, high temperature glass, refillable pH electrode with temperature sensor
HI11310	Glass body, double junction, refillable pH/temperature electrode
HI11311	Glass body, double junction, refillable pH/temperature electrode with enhanced diagnostics
HI12300	Plastic body, double junction, gel filled, non refillable pH/temperature electrode
HI12301	Plastic body, double junction, gel filled, non refillable pH/temperature electrode with enhanced diagnostics
HI10480	Glass body, double junction with temperature sensor for wine analysis
FC2320	Double junction, open reference, non refillable, electrolyte viscolene, PVDF body with conical tip, pH/temperature electrode
FC2100	Double junction, open reference, non refillable, electrolyte viscolene, glass body with conical tip, pH/temperature electrode
FC2020	Double junction, open reference, non refillable, electrolyte viscolene, PVDF body with conical tip, pH/temperature electrode

Note: The enhanced diagnostics information are not displayed by meter.

13.3. pH SOLUTIONS

BUFFER SOLUTIONS

Code	Description
HI70004P	pH 4.01 buffer sachet, 20 mL (25 pcs.)
HI70007P	pH 7.01 buffer sachet, 20 mL (25 pcs.)
HI70010P	pH 10.01 buffer sachet, 20 mL (25 pcs.)
HI7001L	pH 1.68 buffer solution, 500 mL
HI7004L	pH 4.01 buffer solution, 500 mL
HI7006L	pH 6.86 buffer solution, 500 mL
HI7007L	pH 7.01 buffer solution, 500 mL
HI7009L	pH 9.18 buffer solution, 500 mL
HI7010L	pH 10.01 buffer solution, 500 mL
HI8004L	pH 4.01 buffer solution in FDA approved bottle, 500 mL
HI8006L	pH 6.86 buffer solution in FDA approved bottle, 500 mL
HI8007L	pH 7.01 buffer solution in FDA approved bottle, 500 mL
HI8009L	pH 9.18 buffer solution in FDA approved bottle, 500 mL
HI8010L	pH 10.01 buffer solution in FDA approved bottle, 500 mL

ELECTRODE STORAGE SOLUTIONS

Code	Description
HI70300L	Storage solution, 500 mL
HI80300L	Storage solution in FDA approved bottle, 500 mL

ELECTRODE CLEANING SOLUTIONS

Code	Description
HI70000P	Electrode rinse sachet, 20 mL (25 pcs.)
HI7061L	General cleaning solution, 500 mL
HI7073L	Protein cleaning solution, 500 mL
HI7074L	Inorganic cleaning solution, 500 mL
HI7077L	Oil & fat cleaning solution, 500 mL
HI8061L	General cleaning solution in FDA approved bottle, 500 mL
HI8073L	Protein cleaning solution in FDA approved bottle, 500 mL
HI8077L	Oil & fat cleaning solution in FDA approved bottle, 500 mL

ELECTRODE REFILL ELECTROLYTE SOLUTIONS

Code	Description
HI7082	3.5M KCl electrolyte, 4x30 mL, for double junction electrodes
HI8082	3.5M KCl electrolyte in FDA approved bottle, 4x30 mL, for double junction electrodes

13.4. OTHER ACCESSORIES

Code	Description
HI72083300	carrying case
HI731318	cloth for wiping cuvettes (4 pcs.)
HI731331	glass cuvette (4 pcs.)
HI731335N	cap for cuvette (4 pcs.)
HI731340	200 μ L automatic pipette
HI731341	1000 μ L automatic pipette
HI731342	2000 μ L automatic pipette
HI740034P	cap for 100 mL beaker (10 pcs.)
HI740036P	100 mL plastic beaker (10 pcs.)
HI740038	60 mL glass bottle and stopper
HI740142P	1 mL graduated syringe (10 pcs.)
HI740143	1 mL graduated syringe (6 pcs.)
HI740144	pipette tip (6 pcs.)
HI740157P	plastic refilling pipette (20 pcs.)
HI740220	25 mL graduated glass vial (2 pcs.)
HI740224	170 mL plastic beaker (12 pcs.)
HI740225	60 mL graduated syringe
HI740226	5 mL graduated syringe
HI740227	filter assembly
HI740228	filter disc (25 pcs.)
HI740229	100 mL graduated cylinder
DEMI-02	demineralizer
HI75110/220E	USB power adapter, European plug

Code	Description
HI75110/220U	USB power adapter, USA plug
HI76404A	electrode holder
HI83308-11	CAL Check cuvette kit for HI83308
HI83300-100	Sample preparation kit consisting of activated carbon for 50 tests, demineralizer bottle for 10 L of water, 100 mL graduated beaker with cap, 170 mL graduated beaker with cap, 3 mL pipette, 60 mL syringe, 5 mL syringe, graduated cylinder, spoon, funnel, filter paper (25 pcs.)
HI920015	USB to micro USB cable connector
HI93703-50	cuvette cleaning solution (230 mL)
HI93703-55	activated carbon (50 pcs.)

CERTIFICATION

All Hanna Instruments conform to the CE European Directives.



Disposal of Electrical & Electronic Equipment. The product should not be treated as household waste. Instead hand it over to the appropriate collection point for the recycling of electrical and electronic equipment which will conserve natural resources.

Ensuring proper product disposal prevents potential negative consequences for the environment and human health. For more information, contact your city, your local household waste disposal service, the place of purchase or go to www.hannainst.com.



RECOMMENDATIONS FOR USERS

Before using this product, make sure it is entirely suitable for your specific application and for the environment in which it is used. Any variation introduced by the user to the supplied equipment may degrade the photometer's performance. For your and the meter's safety do not use or store the photometer in hazardous environments.

WARRANTY

The **HI83308** is warranted for two years against defects in workmanship and materials when used for its intended purpose and maintained according to instructions. This warranty is limited to repair or replacement free of charge. Damage due to accidents, misuse, tampering or lack of prescribed maintenance is not covered.

If service is required, contact your local Hanna Instruments Office. If under warranty, report the model number, date of purchase, serial number (engraved on the bottom of the meter) and the nature of the problem. If the repair is not covered by the warranty, you will be notified of the charges incurred. If the instrument is to be returned to Hanna Instruments, first obtain a Returned Goods Authorization (RGA) number from the Technical Service department and then send it with shipping costs prepaid. When shipping any instrument, make sure it is properly packed for complete protection.

Hanna Instruments reserves the right to modify the design, construction or appearance of its products without advance notice.

World Headquarters

Hanna Instruments Inc.
Highland Industrial Park
584 Park East Drive
Woonsocket, RI 02895 USA
www.hannainst.com



MAN83308

Printed in ROMANIA