



HI931

AUTOMATIC POTENTIOMETRIC TITRATOR

**Dear
Customer,**

Thank you for choosing a Hanna Instruments product.

This manual has been written for **HI931** Automatic Potentiometric Titrator with software version 1.03 and higher.

Please read this instruction manual carefully before using this instrument. This manual will provide you with the necessary information for the correct use of this instrument, as well as a precise idea of its versatility.

If you need additional technical information, do not hesitate to e-mail us at tech@hannainst.com or view our contact list for a Hanna Instruments representative near you at www.hannainst.com.



INTRODUCTION

The **HI931** is an automatic potentiometric titrator with high accuracy, great flexibility and repeatability.

The titrator is designed to perform a variety of potentiometric titrations, allowing the user to obtain both good results and high-speed analysis.

The main attributes of the **HI931** titrator are:

- Small footprint, requires minimal bench space
- Casing made with strong, chemically resistant plastic
- Flexible electrode holder supports up to 3 electrodes, 4 dispensing tubes, 1 temperature sensor and removable stirrer
- Electrode holder positions electrodes in the center of beaker, allowing for smaller sample sizes
- Support for 100 titration methods
- User-customizable reports
- Integrated research grade pH/mV/ISE meter
- Clearly displayed warning and error messages

This manual provides information regarding installation and functionality of the titrator and refined operation suggestions. Before using the titrator, it is recommended you become familiar with its various features and functionality.

This manual is divided into four parts:

PART 1: QUICK START GUIDE

Helps the user quickly setup and operate **HI931** Automatic Potentiometric titrator. It covers basic connections, user interface and how to run a titration.

PART 2: INSTRUCTION MANUAL

Provides a comprehensive description of the operating principles, user interface, general options, methods, titration mode, optimization, maintenance etc.

PART 3: APPLICATIONS

Contains complete instructions for commonly-used analyses. Additional methods and method packs are available, contact your local Hanna Instruments office for more details.

PART 4: TITRATION THEORY

Outlines the principles of operation of the titrator. It covers the chemistry of titrations, titration types and result calculations.



TABLE OF CONTENTS

PART 1: QUICK START GUIDE

1. SAFETY MEASURES	1-2
2. ABBREVIATIONS	1-2
3. TITRATOR CONNECTIONS	1-3
3.1. FRONT VIEW	1-3
3.2. REAR VIEW	1-4
4. USER INTERFACE	1-4
4.1. KEYPAD	1-4
4.2. DISPLAY	1-5
5. LANGUAGE	1-5
6. CONTEXTUAL HELP	1-5
7. METHODS	1-6
7.1. STANDARD METHODS	1-6
7.2. USER-DEFINED METHODS	1-6
8. HOW TO CALIBRATE A pH ELECTRODE	1-6
8.1. PREPARATION	1-6
8.2. CALIBRATION PROCEDURE	1-6
9. THE FIRST TITRATION	1-7
9.1. REQUIRED SOLUTIONS	1-7
9.2. PRIMING THE BURETTE	1-7
9.3. METHOD SELECTION	1-7
9.4. SETTING METHOD PARAMETERS	1-8
9.5. SETTING UP TITRATION REPORT	1-8
9.6. PREPARING THE SAMPLE	1-8
9.7. PERFORMING A TITRATION	1-9
9.8. TITRATION SCREEN	1-9
9.9. TITRATION GRAPH	1-9
9.10. TITRATION TERMINATION	1-10
9.11. RESULTS	1-10
9.12. VIEWING THE LAST TITRATION DATA	1-11
9.13. PRINTING THE TITRATION REPORT	1-11
9.14. SAVING DATA TO USB STORAGE DEVICE	1-11
9.15. TITRATION REPORT	1-12

PART 2: INSTRUCTION MANUAL

1. SETUP	2-2
1.1. UNPACKING	2-2
1.2. SAFETY MEASURES	2-3
1.3. HI931 TITRATOR TECHNICAL SPECIFICATIONS	2-3
1.4. INSTALLATION	2-5
2. USER INTERFACE	2-13
2.1. START UP	2-13
2.2. KEYPAD	2-13
2.3. DISPLAY	2-15
2.4. MENU NAVIGATION	2-16
3. GENERAL OPTIONS	2-18
3.1. SAVE TO USB	2-18
3.2. RESTORE FROM USB	2-19
3.3. ADMINISTRATION	2-20



3.4. TEMPERATURE	2-21
3.5. DATE & TIME SETTING	2-23
3.6. DISPLAY SETTINGS	2-24
3.7. BEEPER	2-24
3.8. STIRRER	2-25
3.9. LANGUAGE	2-25
3.10. TOTAL VOLUME ALERT	2-26
3.11. TITRANT AGE REMINDER	2-26
3.12. USB LINK WITH PC	2-27
3.13. SETUP BALANCE INTERFACE	2-27
3.14. PRINTER MODE	2-31
3.15. RESET TO DEFAULT SETTINGS	2-32
3.16. OPTIMIZE MEMORY SPACE	2-32
3.17. UPDATE SOFTWARE	2-33
4. TITRATION METHODS	2-34
4.1. SELECTING METHODS	2-34
4.2. STANDARD METHODS	2-34
4.3. USER-DEFINED METHODS	2-36
4.4. VIEWING / MODIFYING METHOD	2-37
4.5. METHOD OPTIONS	2-38
4.6. PRINTING	2-61
5. TITRATION MODE	2-62
5.1. RUNNING A TITRATION	2-62
5.2. STOPPING A TITRATION	2-63
6. pH MODE	2-64
6.1. DISPLAY	2-65
6.2. pH SETUP	2-65
6.3. pH CALIBRATION	2-72
6.4. LOGGING	2-74
7. mV MODE	2-75
7.1. DISPLAY	2-76
7.2. mV SETUP	2-76
7.3. RELATIVE mV CALIBRATION	2-79
7.4. LOGGING	2-79
8. ISE MODE	2-80
8.1. DISPLAY	2-80
8.2. ISE SETUP	2-81
8.3. ISE CALIBRATION	2-90
8.4. LOGGING	2-91
9. AUXILIARY FUNCTIONS	2-92
9.1. BURETTE	2-92
9.2. STIRRER	2-95
9.3. RESULTS	2-95
10. MAINTENANCE & PERIPHERALS	2-99
10.1. BURETTE MAINTENANCE	2-99
10.2. PERIPHERALS	2-102
11. ACCESSORIES	2-105
11.1. SOLUTIONS	2-105
11.2. SENSORS	2-108
11.3. TITRATOR COMPONENTS	2-111



PART 3: APPLICATIONS

HI0001EN 0.1N SODIUM HYDROXIDE TITRANT CONCENTRATION	3-2
HI0002EN 0.1N HYDROCHLORIC ACID TITRANT CONCENTRATION	3-4
HI0003EN 0.1M SODIUM THIOSULFATE TITRANT CONCENTRATION	3-6
HI0010EN 0.1M FERROUS AMMONIUM SULFATE TITRANT CONCENTRATION	3-8
HI0200EN 0.02M SILVER NITRATE TITRANT CONCENTRATION	3-10
HI1004EN ALKALINITY OF WATER	3-12
HI1005EN ACIDITY OF WATER	3-14
HI1007EN CHLORIDE IN WATER	3-16
HI1008EN NEUTRALIZATION WITH SULFURIC ACID	3-18
HI1009EN NEUTRALIZATION WITH SODIUM HYDROXIDE	3-20
HI1011EN TROUBLESHOOTING 1	3-22
HI1012EN TROUBLESHOOTING 2	3-24

PART 4: TITRATION THEORY

1. TITRATION THEORY	4-2
1.1. INTRODUCTION	4-2
1.2. USES OF TITRATIONS	4-2
1.3. ADVANTAGES & DISADVANTAGES	4-2
2. TYPES OF TITRATIONS	4-3
2.1. TITRATIONS ACCORDING TO THE MEASUREMENT METHOD	4-3
2.2. TITRATIONS ACCORDING TO THE REACTION TYPE	4-5
2.3. TITRATIONS ACCORDING TO THE TITRATION SEQUENCE	4-10
3. TITRATION PROCEDURE	4-11
3.1. MANUAL TITRATION	4-11
3.2. AUTOMATIC TITRATION	4-11
4. TITRATION RESULTS	4-13
4.1. ACCURACY	4-13
4.2. REPEATABILITY	4-13
4.3. SOURCES OF ERROR	4-13
5. CALCULATIONS	4-15
5.1. SAMPLE CALCULATION BY MASS	4-15
5.2. SAMPLE CALCULATION BY VOLUME	4-15
5.3. STANDARDIZE TITRANT BY MASS	4-15
5.4. STANDARDIZE TITRANT BY VOLUME	4-16
5.5. BLANK TITRATION	4-16
5.6. MULTIPLE ENDPOINT TITRATION	4-16
6. GLOSSARY	4-18

PART 1:

QUICK START GUIDE



1. SAFETY MEASURES

The following safety measures must be followed:

- 1) Never connect or disconnect the pump assembly or other peripheral with the titrator turned on.
- 2) Verify that the burette and the attached tubing are assembled correctly.
- 3) Always check that the titrant bottle and the titration beaker are placed on a flat, stable surface.
- 4) Always wipe up spills and splashes immediately.
- 5) Avoid the following environmental working conditions
 - Severe vibrations
 - Direct sunlight
 - Atmospheric relative humidity above 95% non-condensing
 - Environment temperatures below 10°C and above 40°C
 - Explosion hazards
- 6) Have the titrator serviced by qualified service personnel only.

2. ABBREVIATIONS

ABS	Acrylonitrile Butadiene Styrene
GLP	Good Laboratory Practice
PEI	Polyetherimide
PTFE	Polytetrafluoroethylene
PVDF	Polyvinylidene fluoride
RPM	Revolutions per minute
eq / kg	Equivalentents per kilogram
eq / L	Equivalentents per liter
g / 100 mL	Grams per 100 milliliters
g / L	Grams per liter
μg / L	Micrograms per liter
meq / kg	Milliequivalentents per kilogram
meq / L	Milliequivalentents per liter
mg / 100 mL	Milligrams per 100 milliliters
mg / g	Milligrams per gram
mg / kg	Milligrams per kilogram
mg / L	Milligrams per liter
mmol / g	Millimoles per gram
mmol / kg	Millimoles per kilogram
mmol / L	Millimoles per liter
M (mol / L)	Molarity (moles per liter)
mol / kg	Moles per kilogram
mol / L	Moles per liter
N (eq / L)	Normality (equivalentents per liter)
ppb (μg / kg)	Parts per billion (micrograms per kilogram)
ppb (μg / L)	Parts per billion (micrograms per liter)
ppm (mg / kg)	Parts per million (milligrams per kilogram)

ppm (mg / L)	Parts per million (milligrams per liter)
ppt (g / kg)	Parts per thousand (grams per kilogram)
ppt (g / L)	Parts per thousand (grams per liter)
% (g / 100 g)	Percent by weight (grams per 100 grams)
%w / v	Percent weight by volume

3. TITRATOR CONNECTIONS

3.1. FRONT VIEW

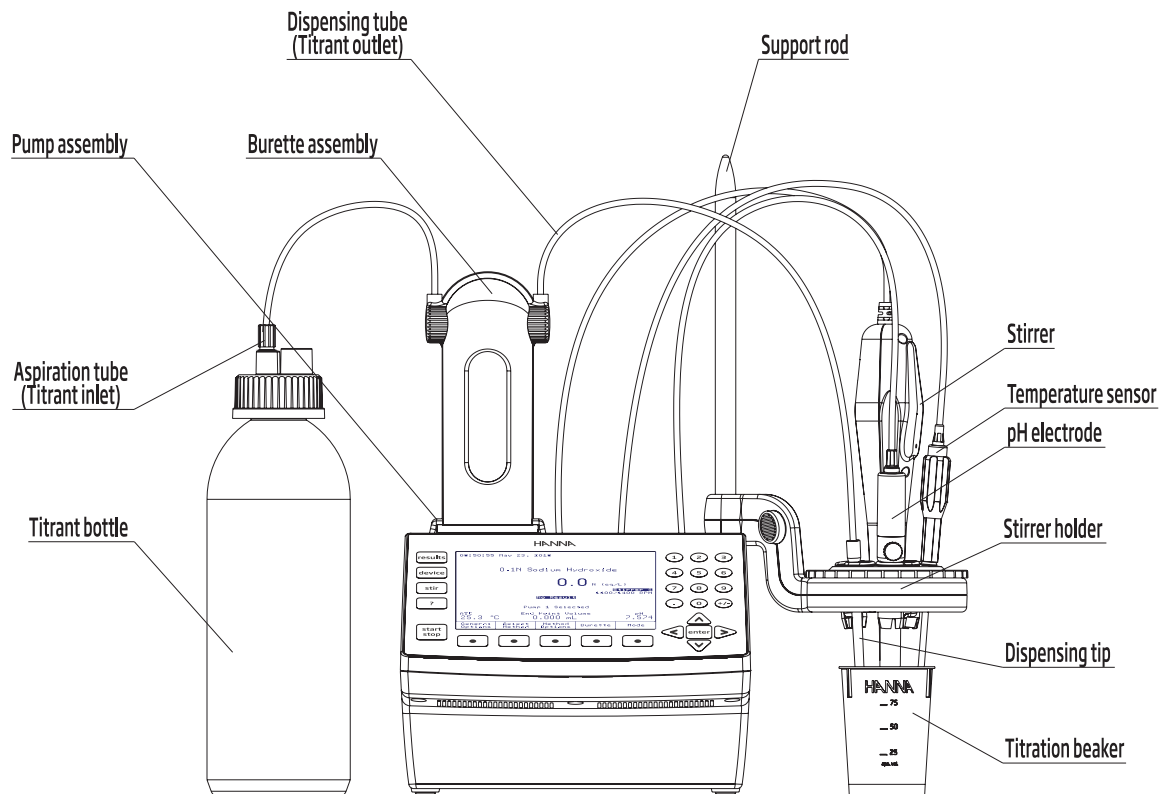

3.2. REAR VIEW

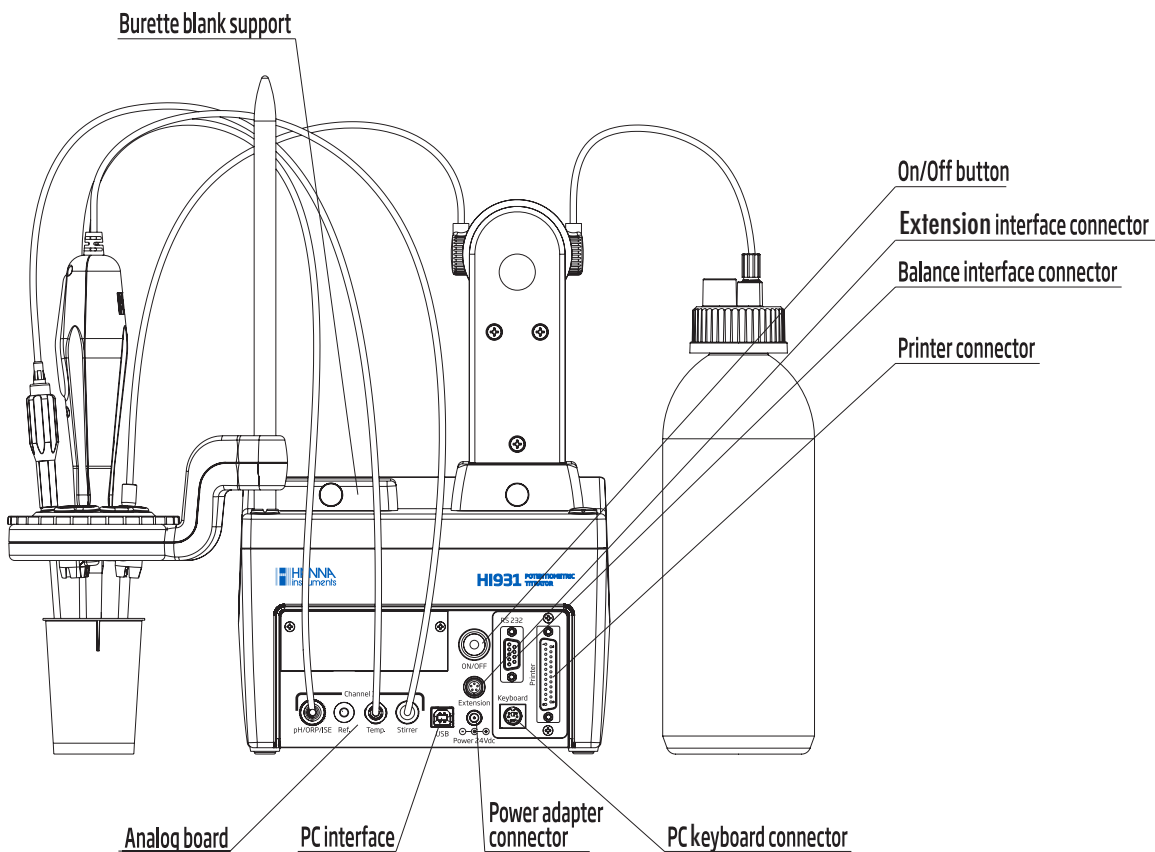

4. USER INTERFACE

4.1. KEYPAD

The titrator's keypad has 27 keys grouped in five categories, as follows:

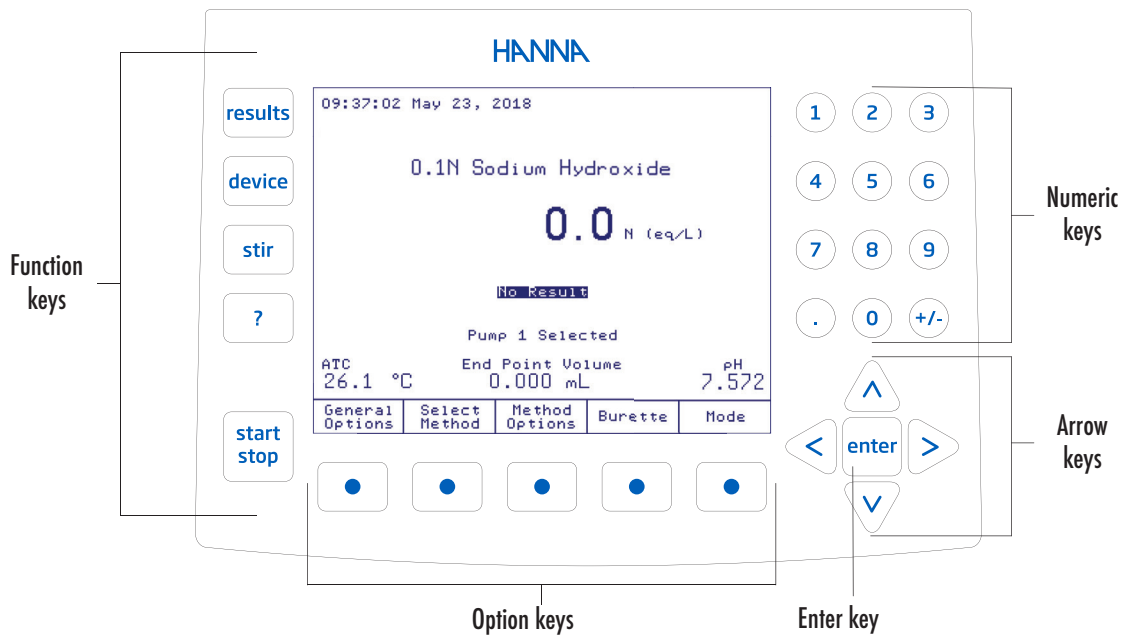

4.2. DISPLAY

The titrator has a 5.7" graphical backlit color display.

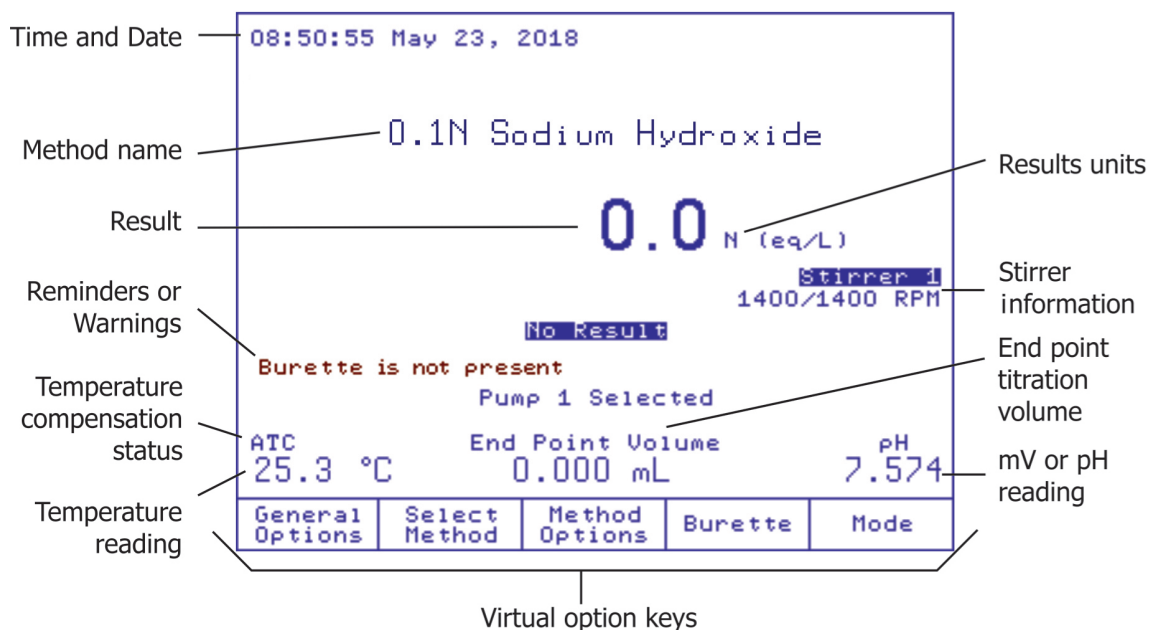

The user interface contains several screens. In each screen, many information fields are present at the same time. The information is displayed in an easy-to-read manner.

Virtual option keys describe the function performed when the corresponding soft key is pressed.

5. LANGUAGE

To change the language, press **General Options** from the main screen. Highlight *Language* option. Using the **▲** and **▼** keys, select the language from the options listed in the **Set Language** screen and press **Select**.

Restart the titrator in order to apply the new language setting.

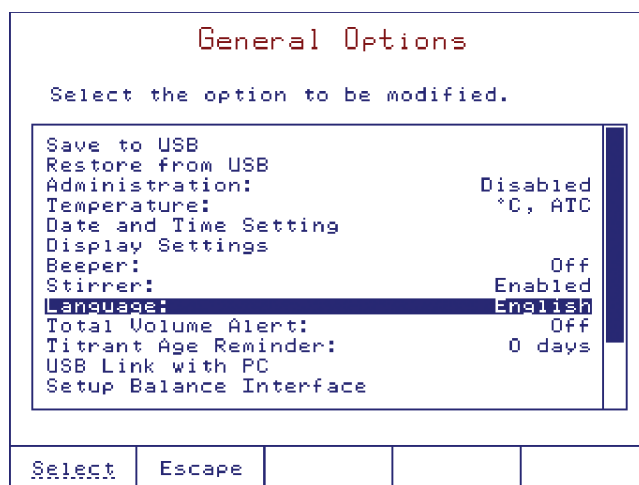

6. CONTEXTUAL HELP

Information about the titrator can be easily accessed by pressing **?**. The contextual help can be accessed at any time and it provides useful information about the current screen.

7. METHODS

The HI931 titrator can store up to 100 methods (standard and user-defined).

7.1. STANDARD METHODS

Each titrator is supplied with a package of standard methods. Standard method packs are developed at Hanna Instruments to meet analysis requirements of specific industries (e.g., water treatment, wine, dairy, etc.).

7.2. USER-DEFINED METHODS

User defined methods allow the user to create and save their own methods. Each new method is based on an existing method which is altered to suit a specific application.

8. HOW TO CALIBRATE A pH ELECTRODE

To enter pH calibration mode, press , then , then

8.1. PREPARATION

Pour small quantities of the buffer solutions into clean beakers. If possible, use plastic beakers to minimize any EMC interferences.

For accurate calibration and to minimize cross-contamination, use two beakers for each buffer solution: one for rinsing the electrode and one for calibration. If you are measuring in the acidic range, use pH 7.01 or 6.86 as the first buffer and pH 4.01/3.00 or 1.68 as the second buffer. If you are measuring in the alkaline range, use pH 7.01 or 6.86 as the first buffer and pH 10.01/9.18 or 12.45 as the second buffer.

For extended range measurements (acidic and alkaline), perform a five-point calibration by selecting five buffers across the entire pH range.

8.2. CALIBRATION PROCEDURE

During calibration, the user has a choice of 8 standard buffers: (pH 1.68, 3.00, 4.01, 6.86, 7.01, 9.18, 10.01, 12.45) and up to 5 custom buffers.

For accurate measurements it is recommended to perform a five-point calibration. However, at least a two-point calibration is suggested. For pH titrations, the selected buffers should bracket your endpoint (e.g. if your endpoint value is at 8.5, use 7.01 or 6.86 and 9.18 or 10.01 for calibration).

To begin calibration:

- 1) Press . If the instrument was calibrated before, previous calibration can be cleared by pressing .

Note: It is very important to clear calibration history when a new electrode is used.

- 2) Immerse the pH electrode and the temperature probe approximately 4 cm (1.5") into a buffer solution and stir gently.
- 3) If necessary, select the pH calibration buffer value with or .
- 4) Once the reading has stabilized, press to update the calibration. The calibration buffer will be added to the Calibrated Buffers section.
- 5) Rinse the pH electrode and the temperature probe, then immerse them into the next buffer solution and follow the above procedure or press to exit the calibration.



9. THE FIRST TITRATION

9.1. REQUIRED SOLUTIONS

- Titrant - 500 mL of 0.1 M (mol/L) Sodium Hydroxide (NaOH) in a titrant bottle.
- Sample - 0.1 mol/L Hydrochloric Acid (HCl).
- Distilled or deionized water.

Note: Analytical grade reagents and water should be used for accurate results.

9.2. PRIMING THE BURETTE

- 1) Insert the aspiration tube in the titrant bottle and the dispensing tube in a waste beaker.
- 2) From the main screen press .
- 3) Highlight the *Prime Burette* option and then press .
- 4) Enter the number of burette rinses. At least 3 rinses are recommended.
- 5) Press  to start. The message "Executing..." will be displayed.

Note: Make sure you have continuous liquid flow inside the burette. For accurate results, the aspiration tube, the dispensing tube and the syringe must be free of air bubbles.

9.3. METHOD SELECTION

For this analysis we will use the **HI1009 Neutralization w/ NaOH** standard method.

To select this method:

- 1) Press  from the Idle screen.
- 2) Use the  and  keys to highlight *HI1009 Neutralization w/ NaOH* method.
- 3) Press .

9.4. SETTING METHOD PARAMETERS

To display the method parameters, press .

The **View/Modify Method** screen will be displayed.

Only certain parameters can be changed.

For this titration, the NaOH titrant concentration and the size of the HCl sample need to be entered.

- 1) Highlight *Titrant Conc.* option, then press . The Titrant Concentration screen will be displayed.
- 2) Enter the correct value, then press .
- 3) Highlight *Analyte Size* option, then press .
- 4) Enter the volume of the sample (e.g.: 5 mL), then press .
- 5) Press , highlight *Save Method* option and then press .

Titrant Concentration

Enter the titrant concentration.

0.10123 M (mol/L)

Accept	Escape	Delete Digit		Exponent
--------	--------	--------------	--	----------

9.5. SETTING UP TITRATION REPORT

Users can select the information that is stored for each titration.

To obtain proper information at the end of the titration, perform the following operations:

- 1) From the main screen, press and the **Data Parameters** screen will be displayed.
- 2) Highlight *Setup Titration Report* option and press .
- 3) Mark the fields to be included with the * symbol using the and keys, and press to toggle the selection.
- 4) Press and then press to return to the main screen.

9.6. PREPARING THE SAMPLE

- 1) Add 50 to 65 mL of distilled / deionized water to the titration beaker.
- 2) Use a pipette or burette to add 5.0 mL of the sample (0.1M Hydrochloric Acid (HCl)) into the same beaker.
- 3) Slide the stirrer assembly up.
- 4) Place the beaker under the stirrer assembly.
- 5) Lower the stirrer assembly until the electrodes are submersed and the stirrer is close to the bottom of the beaker.
- 6) Adjust the level of the sample solution with distilled / deionized water so that the pH electrode bulb is completely immersed in the sample solution and the reference junction of the electrode is 5-6 mm below the surface.

9.7. PERFORMING A TITRATION

From the main screen, press **start stop**. You will be prompted to enter the analyte size. Enter 5 mL and press **enter**. The titrator will start the analysis.

At the end of the titration, the message "Titration Completed" will appear on the display with the final concentration of the analyte in the sample and the equivalence endpoint volume.

9.8. TITRATION SCREEN

During a titration, the following screen is displayed:

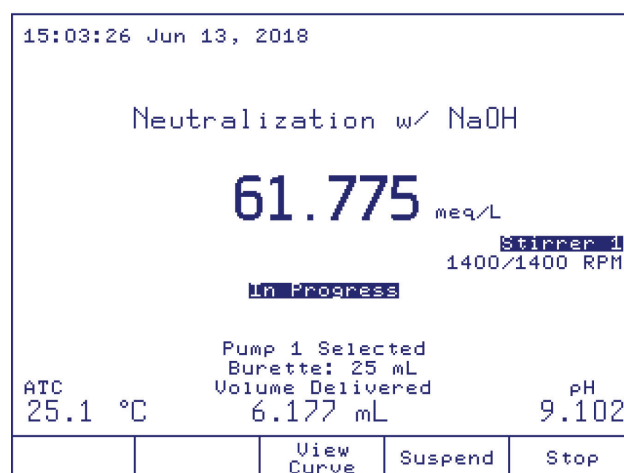

9.9. TITRATION GRAPH

After a few doses are dispensed, **View Curve** will become active. Press **View Curve** to display the real-time titration graph. The curves displayed are plots of the pH and the 1st derivative versus Titrant Volume. See [PART 2: INSTRUCTION MANUAL](#) for more information.

The two graphs are scaled to fit in the same screen window. Press **Select Trace** to change the y-axis scale to either the pH values or the 1st derivative values.

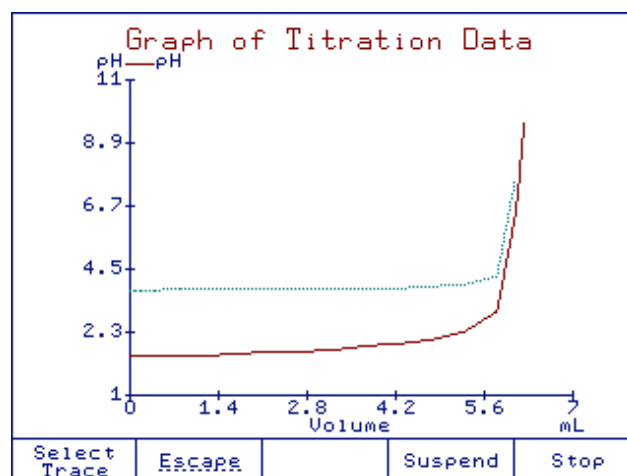

9.10. TITRATION TERMINATION

The titration is terminated when the conditions of the Termination Criteria have been met.

The titration is normally terminated when the first equivalence endpoint is detected according to the selected algorithm. To ensure the correct detection and interpolation of the equivalence endpoint, the titrator will dispense a few additional doses after the endpoint was reached.

The titration result can be displayed either in the main screen or in the Graph of Titration Data screen.

When the titration has ended, the titrator will display the equivalence endpoint volume and the final concentration of the analyte together with the "Titration Completed" message.

To view the titration graph and/or results, press [results](#).

When the titration ends, an "x" will mark the endpoint on the pH versus titrant volume curve in the Graph of Titration Data screen. The value of the endpoint volume is also displayed next to the endpoint

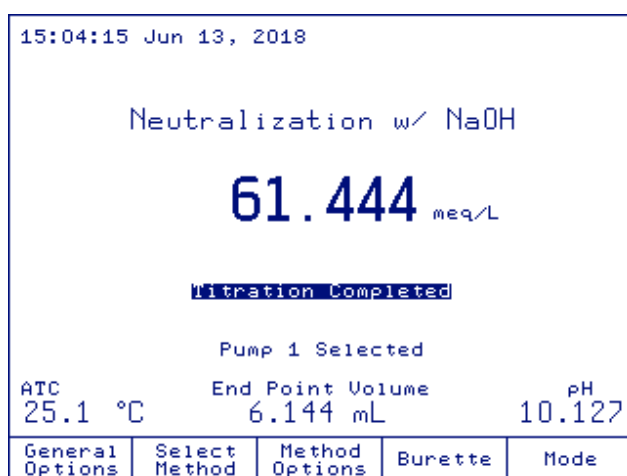

9.11. RESULTS

The results obtained from titration are stored in a report file that can be displayed, transferred to a USB storage device or a PC, or printed.

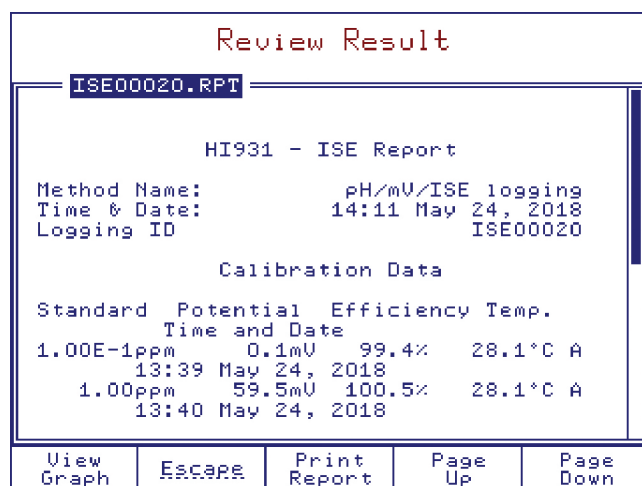

9.12. VIEWING THE LAST TITRATION DATA

To view the last titration report:

- 1) From the main screen, press **results**. The **Data Parameters** screen will be displayed.
- 2) From the **Data Parameters** screen highlight *Review Last Report* option and press **Select**. The **Review Result** screen will be displayed.
- 3) Use the **Page Up** and **Page Down** keys to display information related to the last titration performed.

9.13. PRINTING THE TITRATION REPORT

Connect a DOS / Windows-compatible parallel printer directly to the DB 25 pin connector located on the back of the titrator.

Note: Prior to connecting the printer, ensure that the titrator and the printer have been turned off.

From the **Review Report** screen, press **Print Report**. During the information transfer to the printer, the message "Printing" will be displayed on the screen.

Press **Escape** to return to the **Data Parameters** screen.

Press **Escape** again to return to the main screen.

9.14. SAVING DATA TO USB STORAGE DEVICE

Note: The USB Storage Device has to be formatted FAT or FAT32.

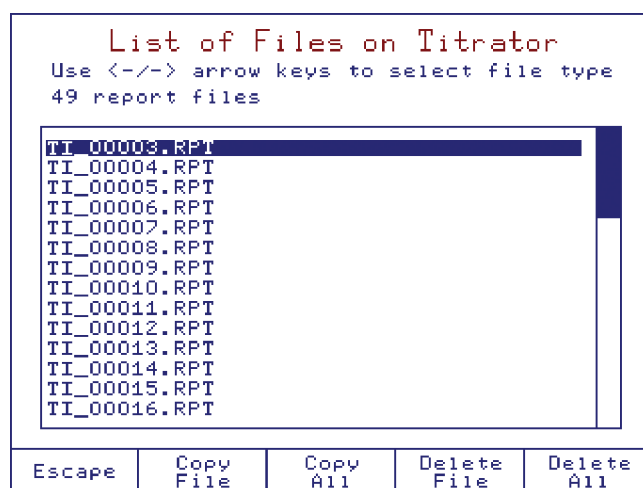

This feature allows saving the results of titrations logging sessions on a USB storage device.

- 1) From the main screen, press **General Options**, the **General Options** screen will be displayed.
- 2) Highlight *Save Files to USB Storage Device* option using the **▲** and **▼** keys.
- 3) Insert the USB storage device into the USB socket.
- 4) Press **Select**, the **List of Files on Titrator** screen will be displayed.
- 5) Use the **<** and **>** keys to select the report files.



- 6) Press **Copy All** to transfer all available reports to the USB storage device, or highlight the name of the report file to be transferred and press **Copy File**. Transferring a report file will automatically transfer the corresponding log file and titration graph (*.BMP file if applicable).
- 7) Press **Escape** to return to the **General Options** screen.
- 8) Press **Escape** again to return to the main screen.

9.15. TITRATION REPORT

While scrolling with the  and  keys, the fields below can be seen on the titrator display or printed. The same information is available on the saved report file (Ti_00011.rpt in this example, with all report fields selected).

HI931 - Titration Report

Method Name: Neutralization w/ NaOH
 Time & Date: 15:01 Jun 13, 2018
 Report ID: Ti_00011

Calibration Data

Buffer	Potential	Efficiency	Temp.
Time and Date			
4.010pH	169.3mV	98.8%	24.0°C A
			11:44 Jun 13, 2018
7.010pH	-5.8mV	98.7%	23.9°C A
			11:42 Jun 13, 2018
10.010pH	-180.7mV	98.7%	24.0°C A
			11:46 Jun 13, 2018

GLP & Meter Information

Sample Name:
 Company Name:
 Operator Name:
 Electrode Name:
 Field 1:
 Field 2:
 Field 3:
 Titrator Software Version: v1.00
 Base Board Software Version: v1.00
 Pump 1 Software Version: v1.00
 Stirrer 1 Software Version: v1.00
 Titrator Serial Number: TT180525011
 Analog Board1 Serial Number: AB180525005
 Pump 1 Serial Number: DP180525004
 Stirrer 1 Serial Number: OS180524001
 Analog 1 Calibration Date: May 25, 2018

Method Parameters

Name: Neutralization w/ NaOH
 Method Revision: 3.0
 Stirrer Configuration:
 Stirrer: Stirrer 1
 Stirring Speed: 1400 RPM
 Pump Configuration:
 Titrant pump: Pump 1
 Dosing Type: Dynamic
 Min Vol: 0.050 mL
 Max Vol: 0.500 mL
 delta E: 20.000 mV
 End Point Mode: pH 1EQ point, 1st Der
 Recognition Options
 Threshold: 50 mV/mL
 Range: NO
 Filtered Derivatives: NO

```

Pre-Titration Volume:      0.000 mL
Pre-Titration Stir Time:   0 sec
Measurement Mode:          Signal Stability
    delta E:                1.0 mV
    delta t:                 2 sec
    Min wait:                2 sec
    Max wait:                15 sec
Electrode Type:            pH
Blank Option:              No Blank
Calculations:              Sample Calc. by Volume
Dilution Option:          Disabled
Titrant Name:              0.1N HaOH
Titrant Conc.:             0.1000 N (eq/L)
Analyte Size:              10.0000 mL
Analyte Entry:             Fixed
Maximum Titrant Volume:    20.000 mL
Potential Range:          -2000.0 to 2000.0 mV
Volume/Flow Rate:         25 mL / 50.0 mL/min
Signal Averaging:         1 Reading
Significant Figures:      XXXXXX

```

N (eq/L) --> meq/L

V eq 1000meq

```

--*--*-----
  L   eq
-----
mL   L
--*--*-----
    1000mL

```

V = volume dispensed in liters.

0.100 eq/L -> titrant conc.

10.000 mL -> sample volume

Nr	Volume [mL]	mV	pH	Graphic	Temp. [°C]	Time
0	0.000	274.4	2.219	0.0	24.9	A 00:00:00
1	0.050	274.4	2.220	1.0	25.0	A 00:00:07
2	0.100	274.4	2.220	0.0	25.0	A 00:00:10
3	0.200	274.3	2.222	-0.8	25.0	A 00:00:12
4	0.400	274.0	2.227	-1.6	25.0	A 00:00:15
5	0.800	273.2	2.241	-2.0	25.0	A 00:00:18
6	1.300	271.5	2.271	-3.4	25.0	A 00:00:24
7	1.800	269.5	2.304	-3.9	25.1	A 00:00:30
8	2.300	267.2	2.344	-4.7	25.1	A 00:00:37
9	2.800	264.4	2.393	-5.7	25.1	A 00:00:43
10	3.300	260.8	2.455	-7.2	25.1	A 00:00:50
11	3.800	256.1	2.535	-9.3	25.1	A 00:00:58
12	4.300	250.3	2.635	-11.7	25.1	A 00:01:05
13	4.800	241.9	2.779	-16.8	25.1	A 00:01:14
14	5.300	228.3	3.011	-27.2	25.1	A 00:01:23
15	5.800	193.0	3.614	-70.5	25.1	A 00:01:31
16	6.077	21.0	6.556	-620.0	25.1	A 00:01:48
17	6.128	-38.2	7.568	-1183.2	25.1	A 00:02:03
18	6.177	-123.6	9.031	-1708.0	25.1	A 00:02:19
19	6.227	-157.7	9.616	-682.8	25.1	A 00:02:28
20	6.278	-174.5	9.903	-335.8	25.1	A 00:02:35
21	6.339	-187.8	10.130	-215.9	25.1	A 00:02:42

Titration Results

Method Name: Neutralization w/ NaOH
Time & Date: 15:01 Jun 13, 2018
Analyte Size: 10.0000 mL
End Point Volume: 6.144 mL
pH Equivalence Point: 8.063
Result: 61.444 meq/L
Initial & Final pH: 2.219 to 10.130
Titration Duration: 2:42 [mm:ss]
Titration went to Completion

Analyst Signature: _____

PART 2:

INSTRUCTION MANUAL



1. SETUP

1.1. UNPACKING

Remove the titrator and accessories from the packaging and examine it carefully. For further assistance, please contact your local Hanna Instruments Office or email us at tech@hannainst.com.

Each **HI931** potentiometric titrator is supplied with:

ITEM	QUANTITY
Titration 1 pc.	1 pc.
Pump assembly 1 pc.	1 pc.
Burette assembly 1 pc.	1 pc.
• Burette with 25 mL syringe	
• Aspiration tube with fitting and protection tube	
• Dispensing tube with dispensing tip, protection tube and tube guide	
• Tube locks	
• Tool for burette cap removal	
• Light spectrum protection screen	
Electrodes holder and stirrer 1 pc.	1 pc.
• Stirrer holder	
• Overhead stirrer	
• Propellers (3 pcs.)	
• Support rod	
Burette blank support 1 pc.	1 pc.
Pump and burette locking screws with plastic head 1 pc.	1 pc.
Temperature sensor 1 pc.	1 pc.
Shorting cap 1 pc.	1 pc.
Power adapter 1 pc.	1 pc.
USB cable 1 pc.	1 pc.
Instruction manual 1 pc.	1 pc.
USB memory stick 1 pc.	1 pc.
HI900 PC application (installation kit on USB memory stick) 1 pc.	1 pc.
Quality certificate 1 pc.	1 pc.

If any of the items are missing or damaged, please contact your local Hanna Instruments Office or email us at tech@hannainst.com.

See **11.3. TITRATOR COMPONENTS** section for component pictures.

Note: Save all packing materials until you are sure that the instrument functions correctly. Any damaged or defective items must be returned in their original packing materials together with the supplied accessories.

1.2. SAFETY MEASURES

The following safety measures must be followed:

1. Never connect or disconnect the pump assembly or other peripheral with the titrator turned on.
2. Verify that the burette and the attached tubing are assembled correctly.
3. Always check that the titrant bottle and the titration beaker are placed on a flat, stable surface.
4. Always wipe up spills and splashes immediately.
5. Avoid the following environmental working conditions
 - Severe vibrations
 - Direct sunlight
 - Atmospheric relative humidity above 95% non-condensing
 - Environment temperatures below 10°C and above 40°C
 - Explosion hazards
6. Have the titrator serviced by qualified service personnel only.

1.3. HI931 TITRATOR TECHNICAL SPECIFICATIONS

Analysis Type	Standard titration (Standardization, Fixed pH / mV, Equivalence point pH / mV)	
Endpoint Mode	Fixed mV	
	Fixed pH	
	mV equivalence point (1 st or 2 nd derivative)	
	pH equivalence point (1 st or 2 nd derivative)	
Burette	Size	5 mL / 10 mL / 25 mL / 50 mL
	Resolution	0.001 mL
	Flow Rate	0.3 mL to 2 x burette volume per minute
	Accuracy	± 0.005 mL (5 mL burette)
		± 0.010 mL (10 mL burette)
± 0.025 mL (25 mL burette)		
± 0.050 mL (50 mL burette)		
Stirrer	Range	200 to 2500 RPM
	Resolution	100 RPM
mV	Range	-2000.0 to 2000.0 mV
	Resolution	0.1 mV
	Accuracy	± 0.1 mV
	Calibration	single point, offset
pH	Range	-2.000 to 20.000 pH
	Resolution	0.1 / 0.01 / 0.001 pH
	Accuracy	± 0.001 pH
	Calibration	up to five points with standard or custom buffers

ISE	Range	1×10^{-6} to 9.999×10^{10}
	Resolution	1 / 0.1 / 0.01
	Accuracy	± 0.001 pH
	Calibration	up to five points
Temperature	Range	-5.0 to 105 °C 23.0 to 221.0 °F 268.2 to 378.2 K
	Resolution	0.1 °C / 0.1 °F / 0.1 K
	Accuracy	± 0.1 °C / ± 0.2 °F / ± 0.1 K
Data Storage	Methods	up to 100 titration methods (standard and user-defined)
	Reports	up to 100 titration and pH / mV / ISE reports
Connections	Measurement	1 x BNC socket (pH, ORP, ISE half-cell and ISE combination electrodes) 1 x 4 mm banana socket (reference electrode) 1 x RCA socket (temperature sensor) 1 x 6-pin connector (stirrer)
	Peripheral	1 x 6-pin mini DIN (external PC keyboard) 1 x DB-25 socket (printer) 1 x USB standard B (PC connection) 1 x DB-9 socket (analytical balance) 1 x USB standard A (USB flash drive)
Additional Specifications	Electrode Holder	4 x multi-purpose slots (titrant tubes) 3 x 12-mm electrode slots 1 x temperature sensor slot 1 x overhead stirrer slot
	Display	5.7" graphical color display with backlight
	Power Supply	100 - 240 VAC, 50 / 60 Hz
	Power Draw	0.5 amps
	Enclosure Material	ABS, PC and Steel
	Keypad	Polyester
	Dimensions	315 x 205 x 375 mm (12.4 x 8.1 x 14.8 ")
	Weight	approximately 4.3 kg (9.5 lbs.) with 1 pump, stirrer and sensors
	Operating Environment	10 to 40 °C (50 to 104 °F); up to 95 % RH
	Storage Environment	-20 to 70 °C (-4 to 158 °F); up to 95 % RH

1.4. INSTALLATION

1.4.1. TITRATOR FRONT VIEW

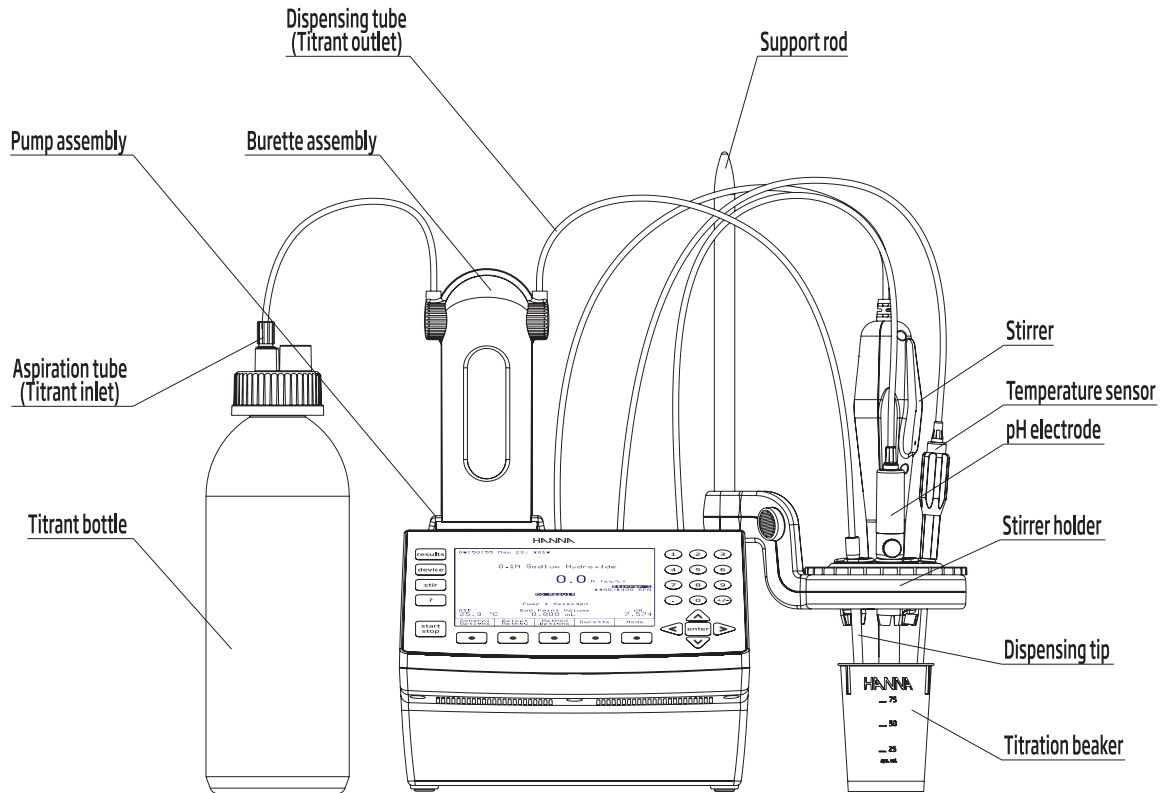

1.4.2. TITRATOR REAR VIEW

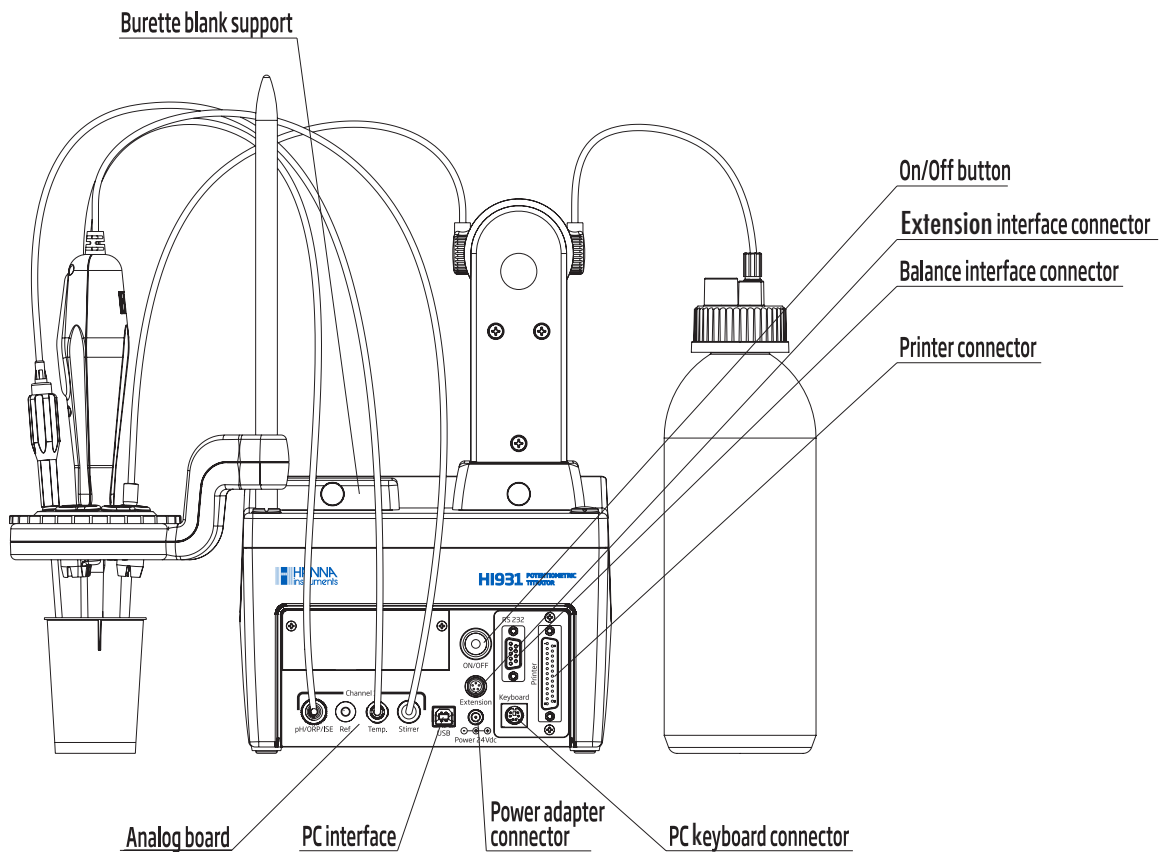

1.4.4. TITRATOR ASSEMBLY

Note: Assembly operations must be completed before connecting the titrator to the power supply!

1.4.4.1. Assembling Support Rod

To insert support rod into the titrator case:

1. Remove protective cap from titrator case
2. Insert the support rods into the titrator case
3. Turn the support rod clockwise to secure it in place

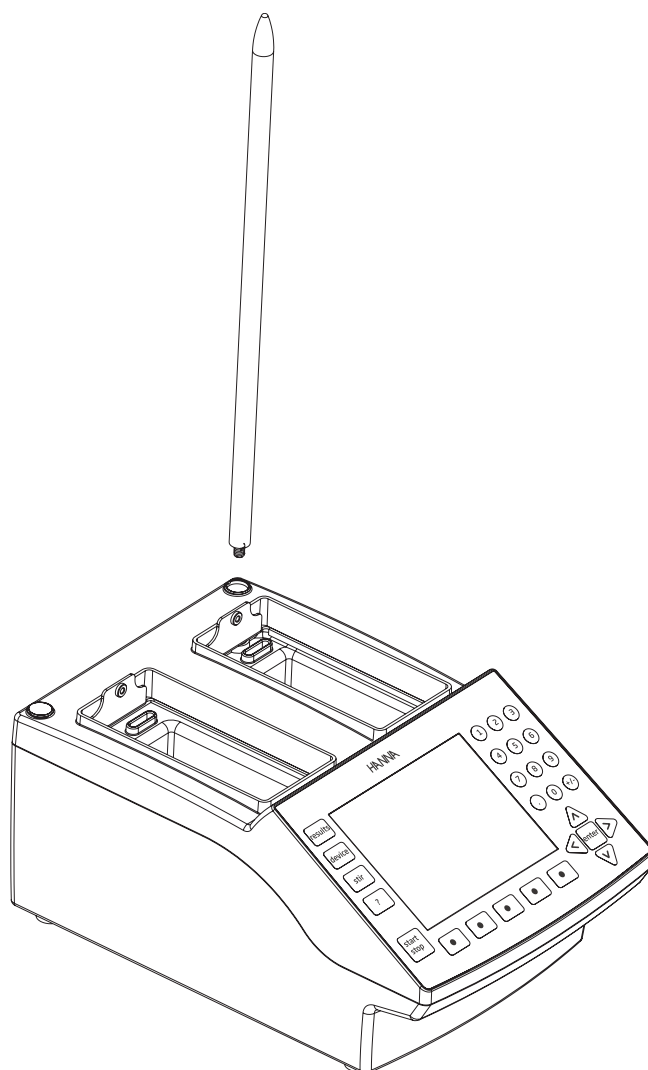

1.4.4.2. Attaching Stirrer & Electrode

To attach the stirrer to the titrator, follow these steps:

1. Place the electrode holder (B) in the stirrer support housing (A). The stirrer support housing can be inverted if necessary.
2. Slide the electrode holder into the support rod and set the desired height using the holder button.
3. Insert electrode (C), temperature sensor (D) and stirrer (E) into the dedicated holes in the electrode holder. Push them until they are in stable position.

Note: For small sample sizes, use the electrode adapter (F) in the center of the holder.

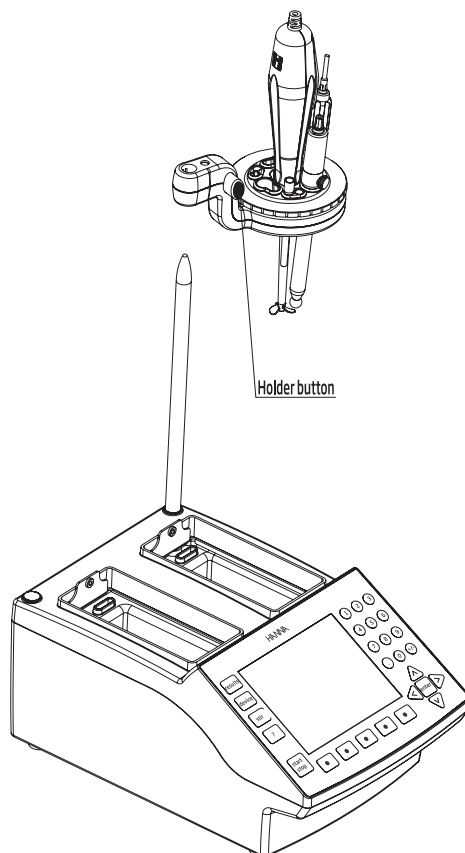
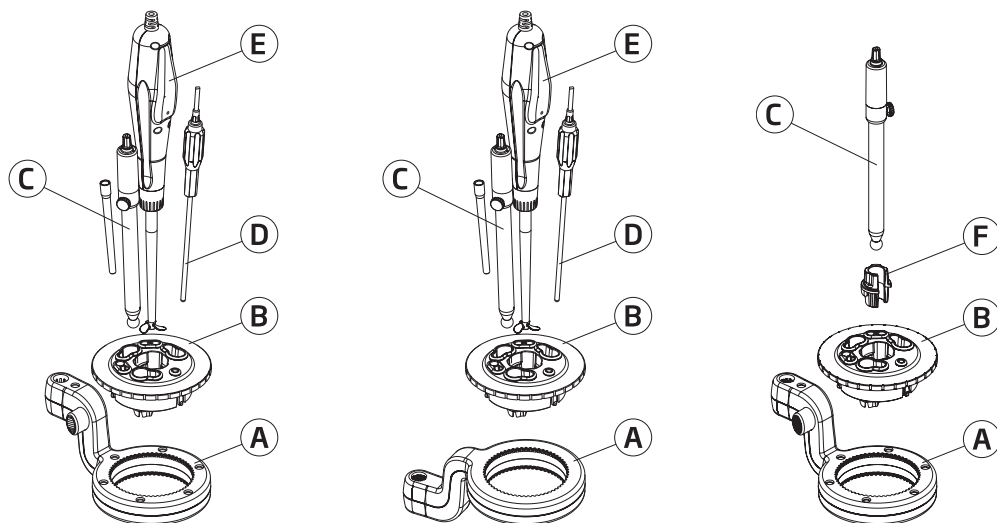

1.4.4.3. Connecting the Pump

To connect the pump, follow these steps:

1. Retrieve the pump cable from inside the bay. The pump 1 connector is located in the left bay and pump 2 connector in the right bay.
2. Connect the cable to the pump as shown below. The pump connector is located on the bottom of the pump.
3. Lower the pump into the titrator, then slide it towards the front of the titrator case until it is firmly latched.
4. Secure the pump with the locking screw.

This procedure can be repeated to connect a second pump.

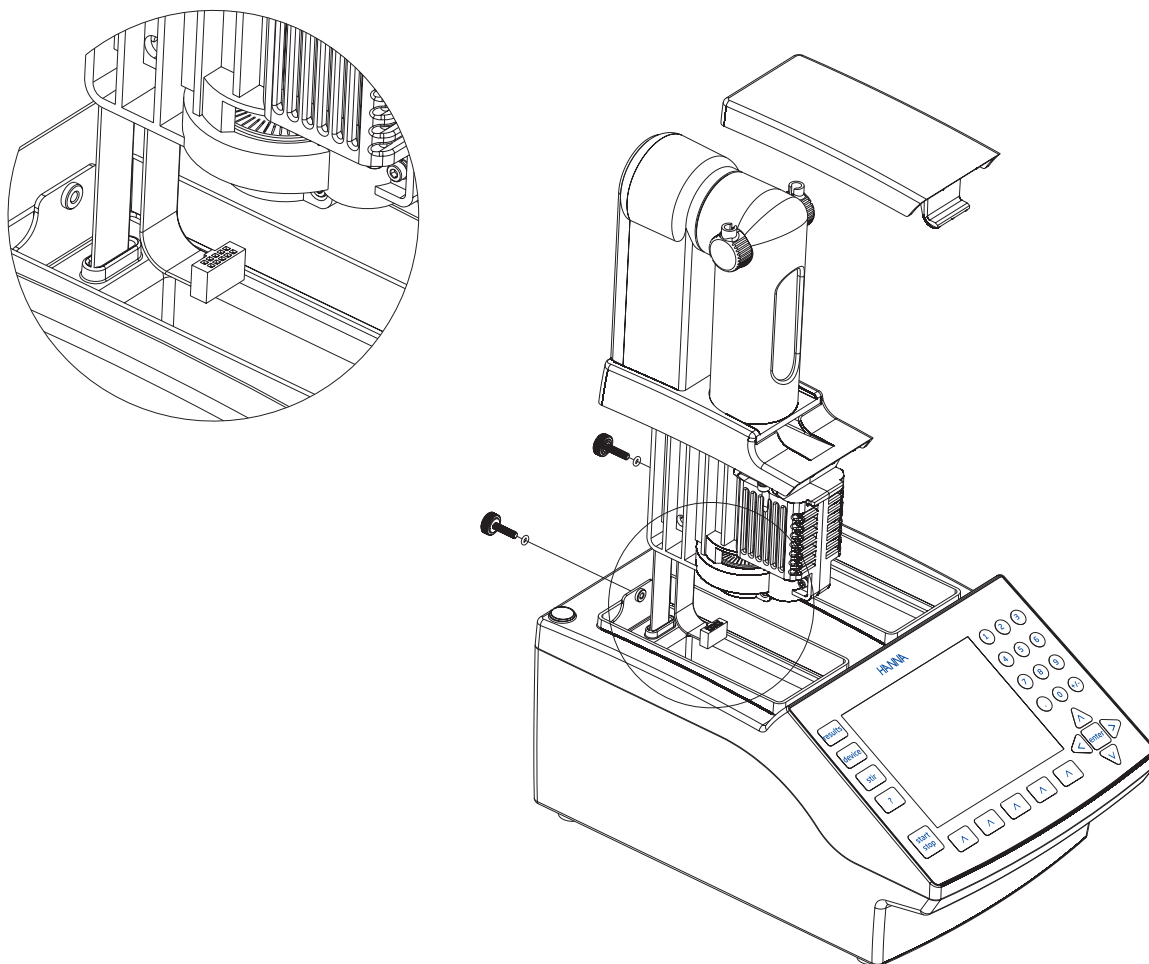

1.4.4.4. Attaching Burette Blank Support

To attach the support, follow these steps:

1. Insert and lower the burette blank support into the titrator's bay.
2. Slide it towards the front of the titrator case until it is firmly latched.
3. Secure the burette blank support with the locking screw.

1.4.4.5. Attaching the Burette

To attach the burette to the pump, follow these steps:

1. Make sure that the mark from the valve actuating cap and from the burette body are aligned.

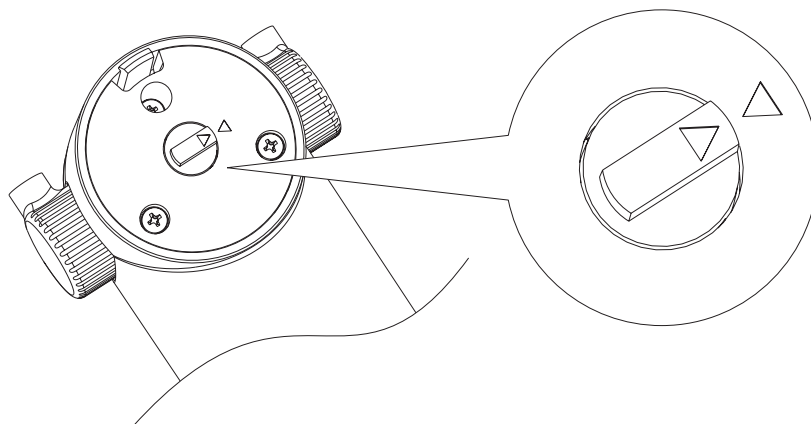

2. Slide the burette into the support on the burette pump. Ensure correct coupling between the syringe plunger (A) and the pump piston (B).

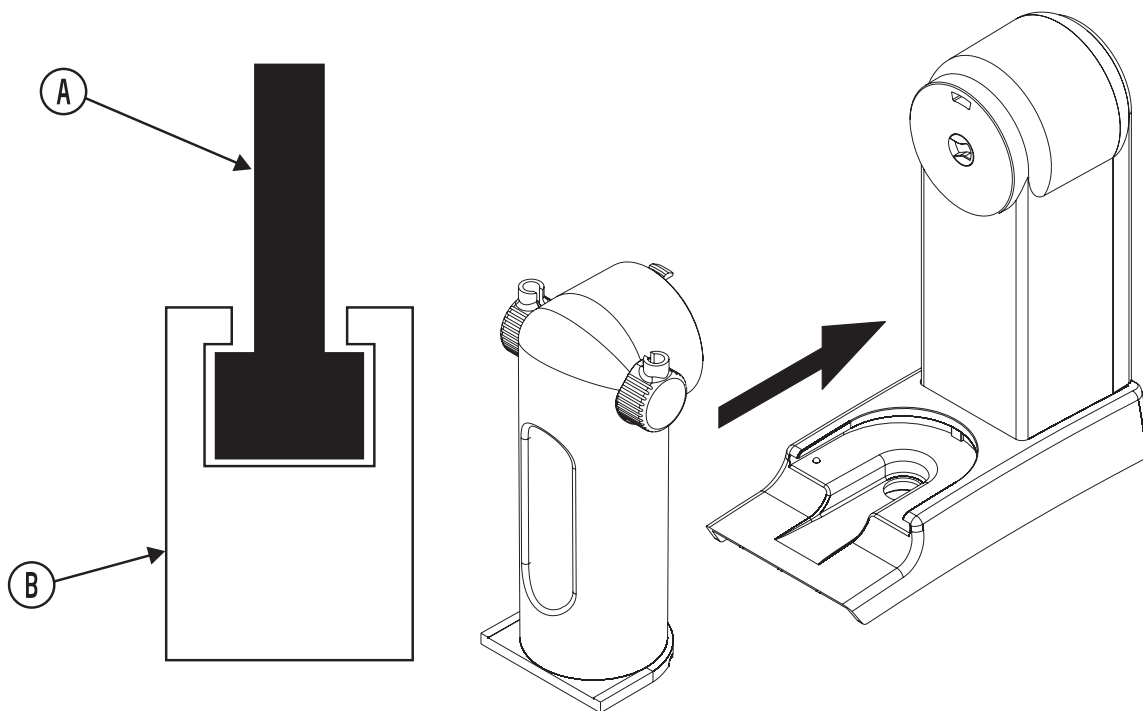

1.4.5. ELECTRICAL CONNECTIONS

1. Connect the electrode to the BNC connector (A).
2. Connect the temperature sensor to the RCA connector (C).
3. Connect the stirrer to the MINI-DIN connector (D).
4. Connect the power adapter cable to the power input connector (F).

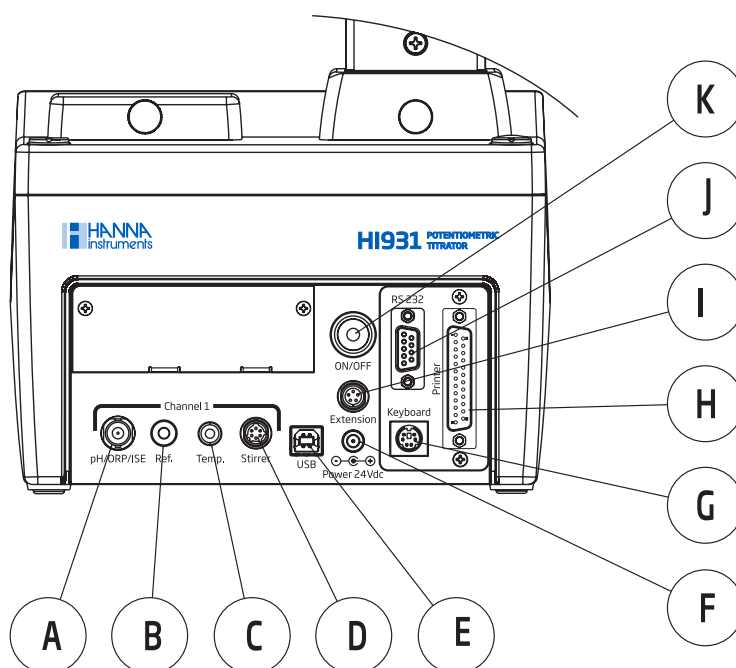

	Function	Type of Connector
A	Connection for pH, ORP, ISE half-cell and ISE combination electrodes	BNC socket
B	Reference electrode	Ø 4 mm banana socket
C	Temperature sensor	RCA socket
D	Stirrer	6-pin connector
E	USB interface	USB standard B
F	Power input connector (24 VDC)	DC power jack connector
G	External PC keyboard	6-pin mini DIN (Standard PS2)
H	Printer	DB-25 socket
I	Extension	5-pin connector
J	Balance interface	DB-9 socket (RS-232)
K	Power switch	

2. USER INTERFACE

2.1. START UP

Once the instrument is assembled and installed, follow the steps below to start the titrator:

1. Connect the titrator to a power outlet with the supplied power adapter.
2. Turn on the titrator using the power button located on the back of the instrument.
3. Wait until the titrator finishes the initialization process.
4. Press  when prompted or wait a few seconds for titrator to start.

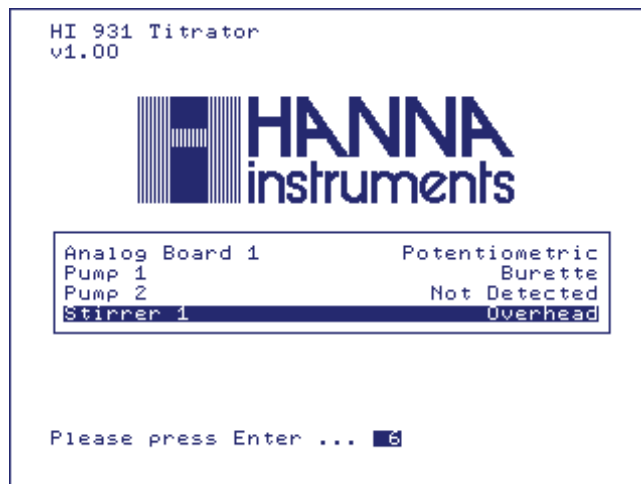

Note: All the performed initialization processes must be successfully completed. If one fails, restart the titrator. If the problem persists, contact your nearest Hanna Instruments Service Center.



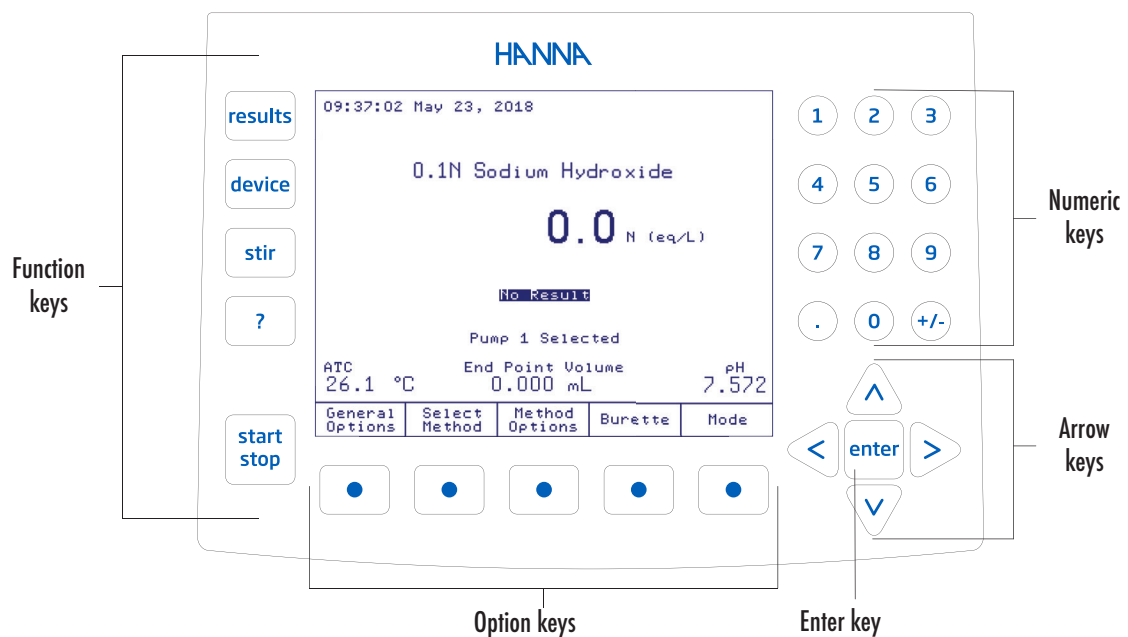

2.2. KEYPAD

The titrator's keypad is grouped into five categories, as follows:



2.2.1. FUNCTION KEYS

If one of these keys is pressed, the associated function is immediately performed. Some of the keys are active only in specific screens:

-  Starts or stops a titration process
-  Turns the selected stirrer on and off
-  Reserved
-  Access the data parameters menu (reports, GLP, meter information, report setup)
-  Displays contextual help

2.2.2. OPTION KEYS

These keys are assigned to the virtual keys on the display. Their functions are listed in the boxes above the buttons and vary depending on the displayed screen.





An underlined virtual key can also be activated by pressing .

2.2.3. ARROW KEYS

These keys have the following functions:

- Move the on-screen cursor.
- Increase or decrease the stirrer speed and other settings.
- Select a character (alphanumeric screen only).
- Navigate through menu options.

2.2.4. NUMERIC KEYS

-  to  Used for numeric entries.
-  Toggles between positive and negative values.
-  Used for decimal point.

2.2.5. ENTER KEY

This key has the following functions:

- Accepts alphanumeric data entry.
- Executes the default (underlined) virtual option key.

2.3. DISPLAY

The titrator has a large color graphical display. The main screen is shown below with short explanations of the screen segments.

2.3.1. THE MAIN SCREEN

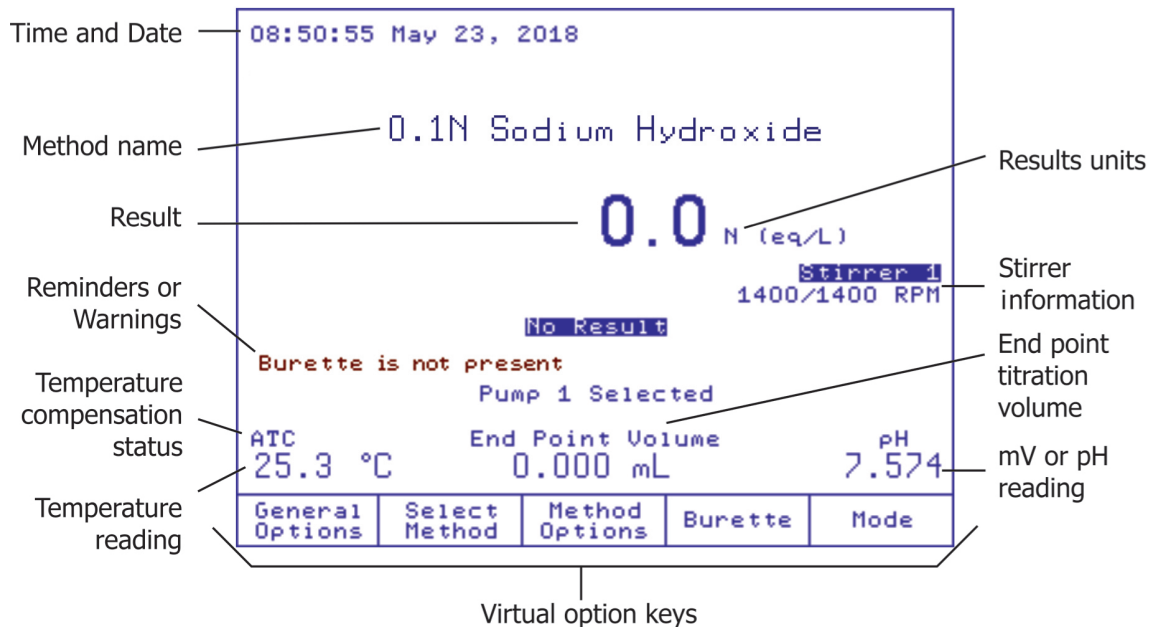

The user interface contains several screens. For each titrator function, several screens may be used.

Method name	Displays the name of the selected method.
Time and Date	Displays the current date and time.
Temperature reading	Displays the measured temperature.
ATC	Automatic temperature compensation
Manual	Manual temperature compensation
Manual	Temperature probe is not connected, manual temperature compensation
Stirrer information	The selected stirrer, actual and set stirrer speed is displayed in RPM. When stirrer is off, the stirrer information is not displayed.
Endpoint volume	Displays the volume delivered to reach the titration endpoint. When no titration has been performed, the displayed volume is "0.000 mL".
Result	Displays the titration result.
mV or pH reading	Displays the current reading. The reading will be in mV or pH.
mV	Indicates actual potential reading.
rel mV	Indicates relative potential reading.
pH	Indicates actual pH value.
Titration status	Displays the status of the selected titration.
	No Result is displayed when a titration has not been performed.
Reminders	Indicates when a task needs to be performed and displays errors.
Pump 1 selected	Displays the active pump.

2.4.4. SAVING MODIFICATIONS

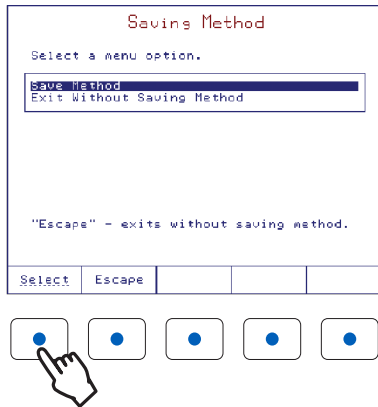

The **Saving Method** screen allows the user to save the modifications. To exit without saving, press `Escape` or highlight *Exit Without Saving Method* option and then press `Select`. To save the modifications, highlight *Save Method* option and then press `Select`.

Note: To access the contextual help menu, press `?` at any time. Help is related to the displayed screen. Press `Escape` or `?` to return to the previous screen.

3. GENERAL OPTIONS

The **General Options** screen gives access to options that are not directly related to the titration process or pH / mV / ISE measurement. To access this screen, press  from the main screen.

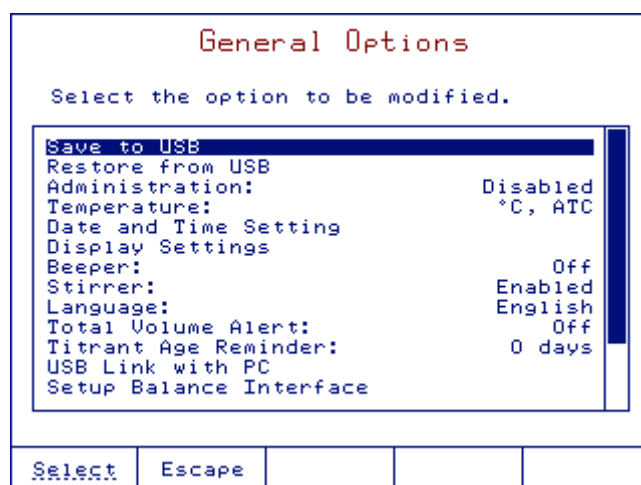

3.1. SAVE TO USB

This option allows the user to save files from the titrator to a USB storage device.

Note: The USB Storage Device has to be formatted FAT or FAT32.

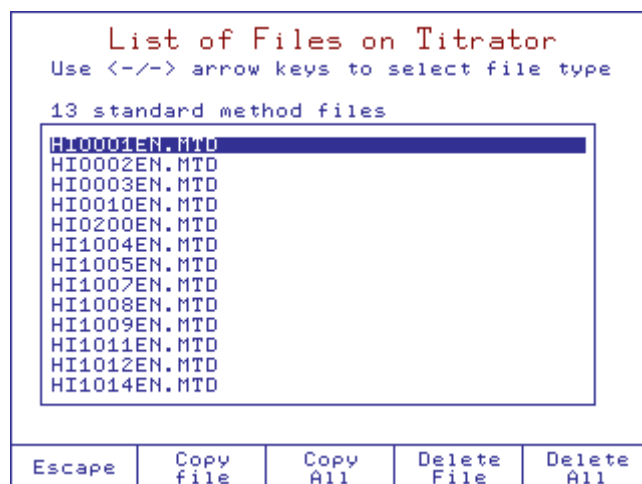

On the titrator, the available file types are:

Standard method HIXXXYY.MTD (e.g.: HI0001EN.MTD, HI1004EN.MTD)

User-defined method USERXXX.MTD (e.g.: USER0001.MTD)

Report Ti_XXXX.RPT, mV_XXXX.RPT, pH_XXXX.RPT, ISEXXXX.RPT, mVrXXXX.RPT (e.g.:
Ti_00001.RPT, mV_00001.RPT, pH_00001.RPT, ISE00001.RPT, mVr00001.RPT)

Insert the USB storage device into the USB port on the right side of the titrator.

Use the  and  keys to select the file type. The number of files and the file names will be displayed.

Use the  and  keys to scroll through the list.

The option keys allow the following operations:

- Escape Returns to the **General Options** screen.
- Copy File Copies highlighted file from the titrator to USB storage device.
- Copy All Copies all displayed files from the titrator to USB storage device.
- Delete File Deletes the highlighted file.
- Delete All Deletes all displayed files.

Note: The saved files will be stored on the USB key in the **HI931** folder, as follows:

Methods USB Drive\HI931\Methods*.mtd

Reports USB Drive\HI931\Reports*.rpt

3.2. RESTORE FROM USB

This screen allows the user to transfer files from the USB storage device to the titrator.

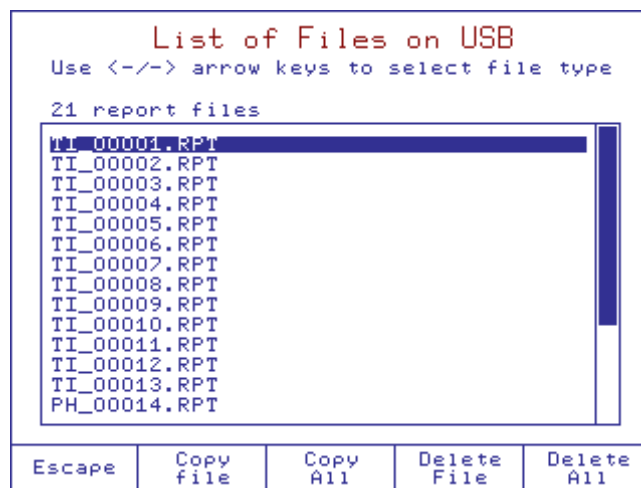

The file types that can be transferred are:

Standard method HIXXXYY.MTD (e.g.: HI0001EN.MTD, HI1004EN.MTD)

User-defined method USERXXX.MTD (e.g.: USER0001.MTD)

Report Ti_XXXX.RPT, mV_XXXX.RPT, pH_XXXX.RPT, ISEXXXX.RPT, mVrXXXX.RPT (e.g.:
Ti_00001.RPT, mV_00001.RPT, pH_00001.RPT, ISE00001.RPT, mVr00001.RPT)

Insert the USB storage device into the USB port on the right side of the titrator.

Use the < and > keys to select the file type. The number of files and the file names will be displayed.

Use the ^ and v keys to scroll through the list.

The option keys allow the following operations:

- Escape Returns to the **General Options** screen.
- Copy File Copies the highlighted file from the USB storage to the titrator.
- Copy All Copies all displayed files from the USB storage to the titrator.
- Delete File Deletes the highlighted files from the USB storage device.
- Delete All Deletes all displayed files from the USB storage device.

Note: In order to restore files from USB Key, please ensure that the methods and / or reports you wish to transfer to the titrator are in the correct folder:

Methods USB Drive\HI931\Methods*.mtd

Reports USB Drive\HI931\Reports*.rpt

3.3. ADMINISTRATION

A 4-digit numeric PIN can be set to prevent unauthorized changes from being made.

When the user enters administration mode and a pin has not been set, the user will be prompted to enter a new PIN.

Titrator Administration				
Administrator PIN has not been set. Enter a 4-digit PIN to enable Administrator function.				
Enter PIN: <input type="password" value="----"/>				
Confirm PIN: <input type="password" value="----"/>				
Your PIN must be 4-digits long.				
Next	Escape	Delete Digit		

Once a PIN has been set, the titrator can be locked. When a titrator is locked, the users cannot modify methods or delete reports. Basic functions are still available (review reports, save to USB, etc.).

Titrator Administration								
Titrator is UNLOCKED.								
<table border="1"> <thead> <tr> <th colspan="2">Lock Titrator</th> </tr> </thead> <tbody> <tr> <td>Enter PIN:</td> <td><input type="password" value="----"/></td> </tr> </tbody> </table>					Lock Titrator		Enter PIN:	<input type="password" value="----"/>
Lock Titrator								
Enter PIN:	<input type="password" value="----"/>							
Accept	Escape	Delete Digit						

To return to administration mode, the titrator can be unlocked by entering the PIN.

Titrator Administration				
Titrator is LOCKED.				
Unlock Titrator	Escape			Recovery PIN

If the PIN is lost or forgotten, press recovery pin and contact technical support to supply the required information.

Recovery PIN				
For recovery PIN, please contact your vendor. When requesting PIN please provide following information:				
Titration Serial Number: 12345678				
Code: 0078				
Recovery PIN: <input type="password" value="----"/>				
Accept	Escape	Delete Digit		

3.4. TEMPERATURE

The temperature menu allows access to all three menu options related to temperature: source, setting and units.

Temperature Menu							
Select temperature option to be modified.							
<table border="1"><tr><td>Temperature Source</td></tr><tr><td>Manual Temperature Setting</td></tr><tr><td>Temperature Units</td></tr></table>					Temperature Source	Manual Temperature Setting	Temperature Units
Temperature Source							
Manual Temperature Setting							
Temperature Units							
Select	Escape						

3.4.1. TEMPERATURE SOURCE

Option: Automatic Temperature or Manual Temperature

Select the temperature source used for temperature compensation.

When Automatic Temperature is selected, "ATC" is displayed on the main screen and the temperature is read by the temperature probe.

When Manual Temperature is selected, "Manual" is displayed on the main screen and a preset temperature value is used for temperature compensation.

Note: The selected temperature source will be indicated in the report files: A for Automatic and M for Manual.

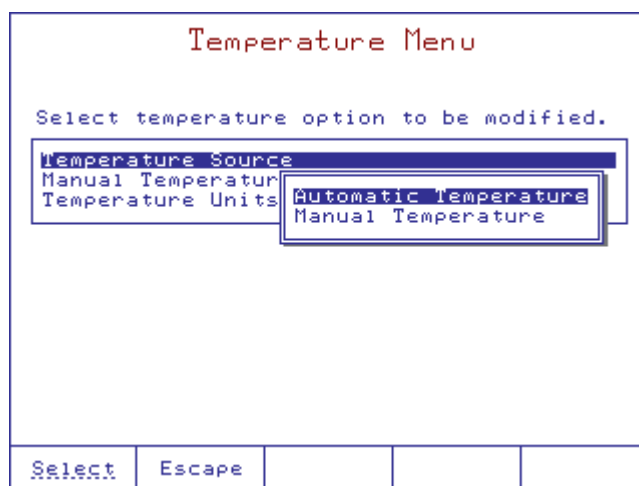

3.4.2. MANUAL TEMPERATURE SETTING

Option: -5.0 to 105.0 °C (23.0 to 221.0 °F, 268.2 to 378.2 K)

If the temperature probe is not connected, the user can manually set the temperature used by the titrator for compensation.

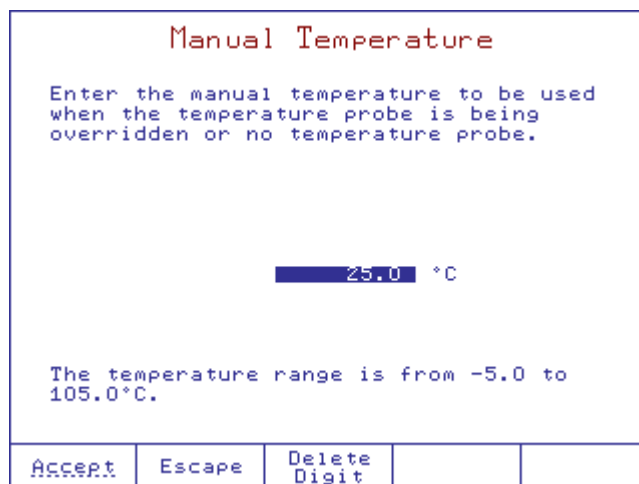

3.4.3. TEMPERATURE UNITS

Option: °C, °F, K

The temperature ranges are as displayed in the **Temperature Units** screen.

Temperature Menu																			
Select temperature option to be modified.																			
<table border="1"> <tr> <td>Temperature Source</td> <td></td> <td></td> <td></td> <td></td> </tr> <tr> <td>Manual Temperature Setting</td> <td></td> <td></td> <td></td> <td></td> </tr> <tr> <td>Temperature Units</td> <td></td> <td></td> <td></td> <td></td> </tr> </table>					Temperature Source					Manual Temperature Setting					Temperature Units				
Temperature Source																			
Manual Temperature Setting																			
Temperature Units																			
<table border="1"> <tr> <td>Celsius</td> <td>-5.0</td> <td>to</td> <td>105.0</td> <td>°C</td> </tr> <tr> <td>Fahrenheit</td> <td>23.0</td> <td>to</td> <td>221.0</td> <td>°F</td> </tr> <tr> <td>Kelvin</td> <td>268.2</td> <td>to</td> <td>378.2</td> <td>K</td> </tr> </table>					Celsius	-5.0	to	105.0	°C	Fahrenheit	23.0	to	221.0	°F	Kelvin	268.2	to	378.2	K
Celsius	-5.0	to	105.0	°C															
Fahrenheit	23.0	to	221.0	°F															
Kelvin	268.2	to	378.2	K															
Select	Escape																		

3.5. DATE & TIME SETTING

This screen allows the user to set the date and time.

Use the  and  keys or the numeric keys to modify the date and time.

 Moves move the cursor to the next field.

 or  Changes the time format.

Date and Time Setting				
Enter the date.				
	<u>2</u>	10	2018	
day		month	year	
Enter the time.				
	20	41	41	
hour		minute	second	
Press <Next> to move to the next entry.				
Accept	Escape	Delete Digit	Next	AM/PM

3.6. DISPLAY SETTINGS

This screen allows the user to customize the display settings.

 Increases the backlight time-saver interval.

 Decreases the backlight time-saver interval.

The backlight intensity can be adjusted using the  and  keys.

There are 8 levels of backlight intensity, ranging from 0 to 7.

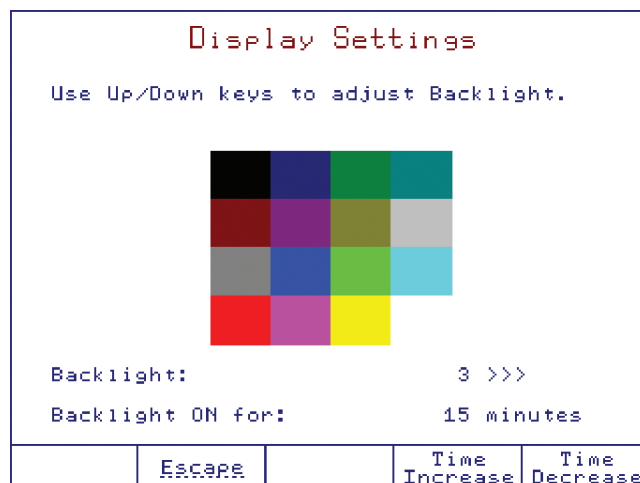

The displayed color palette allows for selection of appropriate backlight intensity.

The backlight time-saver option protects the display during standby periods, when no keys have been pressed for a set amount of time, the backlight will turn off.

If the backlight is off, press any key to reactivate the backlight.

The range for backlight time-saver interval is between 1 and 60 minutes. To disable the backlight time-saver, increase the time to the maximum allowed, the Off indication will be displayed.

3.7. BEEPER

Option: On or Off

If enabled (on) an audible alert will sound after a titration is completed, when an invalid key is pressed or when a critical error occurs during titration.

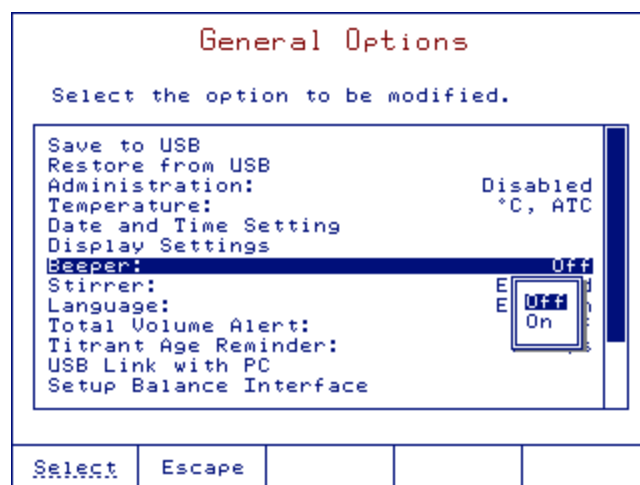

3.8. STIRRER

Option: Enabled or Disabled

The stirrer can be disabled in individual titration method, if necessary.

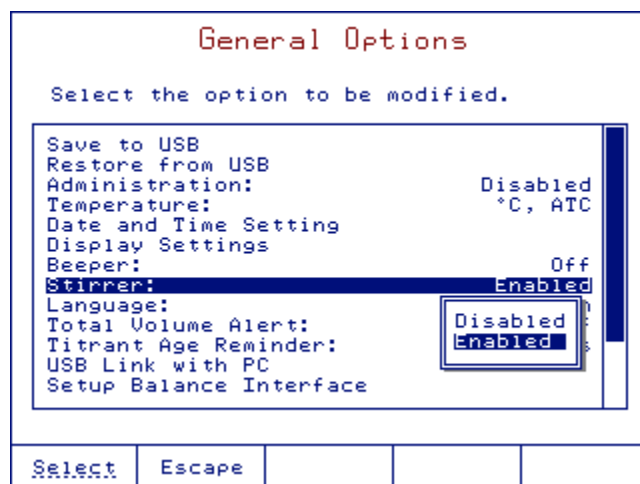

3.9. LANGUAGE

Using the \triangle and ∇ keys, select the language from the options listed and press Select

Restart the titrator in order to apply the new language setting.

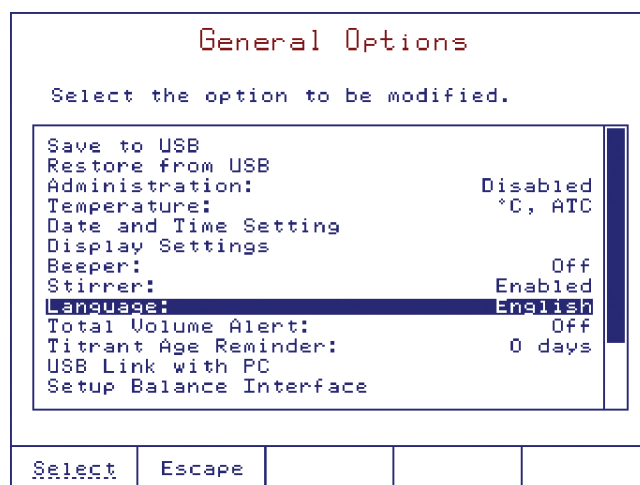

3.10. TOTAL VOLUME ALERT

Option: Off, 0 to 10000 mL

This screen allows a programmable reminder to appear when the titrant reservoir is below 100 mL. The titrant volume will decrease as the titrant is used.

After the new titrant volume has been entered in the **Total Volume Alert** screen, a warning message appears on the main screen reminding the user to re-standardize the newly added titrant.

Off Disables this option.

Total Volume Alert				
Enter the amount of titrant available to the titration/reagent system from its reservoir. The mLs will decrease as the titrant/reagent is depleted.				
10000 mL				
A reminder will appear when less than 100 mLs of titrant volume is left.				
Accept	Escape	Delete Digit		Off

3.11. TITRANT AGE REMINDER

Option: Off, 0 to 31 days

A programmable reminder will appear when it is time to verify the titrant concentration or to change the titrant.

Off Disables this option.

Titrant Age Reminder				
Enter the number of days to pass since the last Titr. Vol. updating or the last Start pressing, whereafter the reminder appears.				
30 days				
The range is from 0 to 31 days.				
Start	Escape	Delete Digit		Off

3.12. USB LINK WITH PC

In order to use this feature, the USB cable needs to connect the titrator with the PC. Make sure that **HI900** PC application is running on the PC.

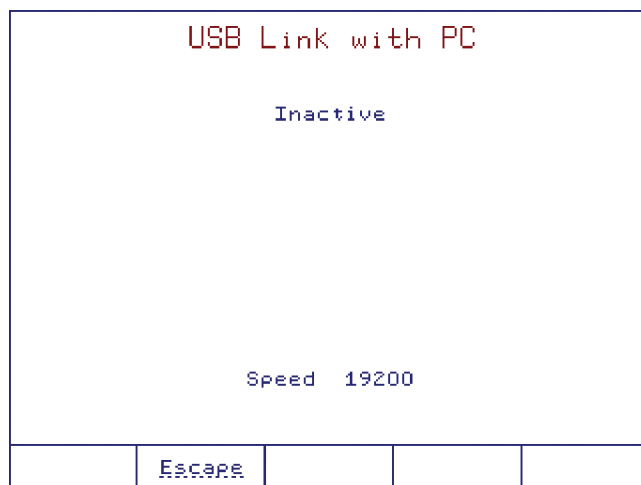

“Active / Inactive” message shows the status of the USB link with the PC.

“Active” means that the titrator is using the USB communication with the PC and not with another device.

“Ready” shows that the titrator is able to communicate with the PC.

During transfer of information between the PC and the titrator, press “Transmit” and the status is displayed.

3.13. SETUP BALANCE INTERFACE

This screen allows the user to setup an analytical balance for automatic acquisition of sample mass prior to titration or standardization.

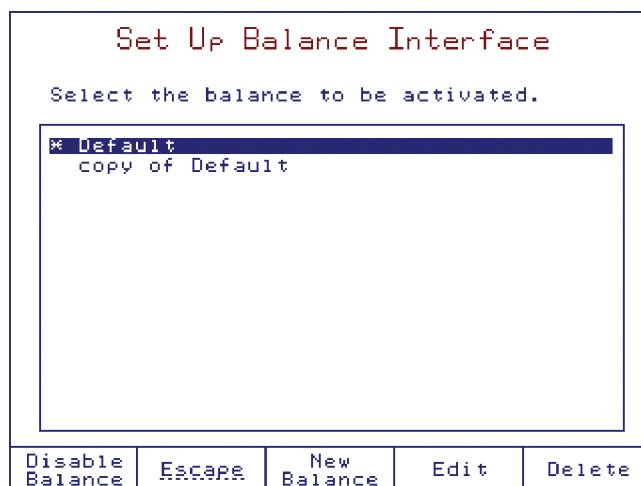

The balance is connected to the titrator via RS 232 interface.

- Enables the selected balance.
- Disables the selected balance (automatic weight acquisition will not be available).
- Returns to the **General Options** screen.
- Adds a new balance to the list.
- Customizes the serial communication parameters. The **Balance Configuration** screen will open.
- Deletes the highlighted balance.

Note: At least one balance must be in the list.

Be sure that the balance configuration settings match the settings of your balance. It may be necessary to change settings on your balance or titrator. Users should consult their balance instruction manual.

Verify connection with the balance is working properly by pressing the  key.

Balance Configuration																
Select the option to be modified.																
<table border="1"> <thead> <tr> <th>Balance Name</th> <th>Default</th> </tr> </thead> <tbody> <tr> <td>Baud Rate</td> <td>9600</td> </tr> <tr> <td>Data Bits</td> <td>8 Bits</td> </tr> <tr> <td>Parity</td> <td>No Parity</td> </tr> <tr> <td>Stop Bit</td> <td>1 bit</td> </tr> <tr> <td>Request Command</td> <td>B</td> </tr> </tbody> </table>					Balance Name	Default	Baud Rate	9600	Data Bits	8 Bits	Parity	No Parity	Stop Bit	1 bit	Request Command	B
Balance Name	Default															
Baud Rate	9600															
Data Bits	8 Bits															
Parity	No Parity															
Stop Bit	1 bit															
Request Command	B															
Select	Escape		Test Balance													

3.13.1. BALANCE NAME

Option: Up to 24 characters

Assign a name for your customized balance.

Balance Name																																																																																																																																																																																					
Select the highlighted letter by using the arrow keys then press "Enter". Select the empty field for a space. Press Accept to save the entered text.																																																																																																																																																																																					
<table border="1"> <tbody> <tr><td>█</td><td>A</td><td>B</td><td>C</td><td>D</td><td>E</td><td>F</td><td>G</td><td>H</td><td>I</td><td>J</td><td>K</td><td>L</td></tr> <tr><td></td><td>M</td><td>N</td><td>O</td><td>P</td><td>Q</td><td>R</td><td>S</td><td>T</td><td>U</td><td>V</td><td>W</td><td>X</td><td>Y</td></tr> <tr><td></td><td>Z</td><td>a</td><td>b</td><td>c</td><td>d</td><td>e</td><td>f</td><td>g</td><td>h</td><td>i</td><td>j</td><td>k</td><td>l</td></tr> <tr><td></td><td>m</td><td>n</td><td>o</td><td>p</td><td>q</td><td>r</td><td>s</td><td>t</td><td>u</td><td>v</td><td>w</td><td>x</td><td>y</td></tr> <tr><td></td><td>z</td><td>À</td><td>Á</td><td>Â</td><td>Ã</td><td>Ä</td><td>Å</td><td>Ç</td><td>È</td><td>É</td><td>Ê</td><td>Ë</td><td>Ì</td><td>Í</td><td>Î</td><td>Ï</td><td>Ñ</td></tr> <tr><td></td><td>Ò</td><td>Ó</td><td>Ô</td><td>Õ</td><td>Ö</td><td>Ù</td><td>Ú</td><td>Û</td><td>Ü</td><td>ß</td><td>à</td><td>á</td><td>â</td><td>ã</td><td>ä</td><td>å</td><td>ä</td></tr> <tr><td></td><td>ä</td><td>ç</td><td>è</td><td>é</td><td>ê</td><td>ë</td><td>ì</td><td>í</td><td>î</td><td>ï</td><td>ò</td><td>ó</td><td>ô</td><td>õ</td><td>ö</td><td>ø</td><td>ö</td></tr> <tr><td></td><td>ù</td><td>ú</td><td>û</td><td>ü</td><td>¿</td><td>¡</td><td>*</td><td>\</td><td>_</td><td>\$</td><td>'</td><td>^</td><td>#</td><td>:</td><td>:</td><td>:</td><td>:</td></tr> <tr><td></td><td>0</td><td>1</td><td>2</td><td>3</td><td>4</td><td>5</td><td>6</td><td>7</td><td>8</td><td>9</td><td>%</td><td>.</td><td>,</td><td>:</td><td>:</td><td>:</td><td>:</td></tr> <tr><td></td><td>?</td><td>!</td><td>(</td><td>)</td><td>[</td><td>]</td><td><</td><td>></td><td>=</td><td>/</td><td>+</td><td>-</td><td>:</td><td>:</td><td>:</td><td>:</td><td>:</td></tr> <tr><td></td><td colspan="13">█ Lab Balance</td></tr> </tbody> </table>					█	A	B	C	D	E	F	G	H	I	J	K	L		M	N	O	P	Q	R	S	T	U	V	W	X	Y		Z	a	b	c	d	e	f	g	h	i	j	k	l		m	n	o	p	q	r	s	t	u	v	w	x	y		z	À	Á	Â	Ã	Ä	Å	Ç	È	É	Ê	Ë	Ì	Í	Î	Ï	Ñ		Ò	Ó	Ô	Õ	Ö	Ù	Ú	Û	Ü	ß	à	á	â	ã	ä	å	ä		ä	ç	è	é	ê	ë	ì	í	î	ï	ò	ó	ô	õ	ö	ø	ö		ù	ú	û	ü	¿	¡	*	\	_	\$	'	^	#	:	:	:	:		0	1	2	3	4	5	6	7	8	9	%	.	,	:	:	:	:		?	!	()	[]	<	>	=	/	+	-	:	:	:	:	:		█ Lab Balance												
█	A	B	C	D	E	F	G	H	I	J	K	L																																																																																																																																																																									
	M	N	O	P	Q	R	S	T	U	V	W	X	Y																																																																																																																																																																								
	Z	a	b	c	d	e	f	g	h	i	j	k	l																																																																																																																																																																								
	m	n	o	p	q	r	s	t	u	v	w	x	y																																																																																																																																																																								
	z	À	Á	Â	Ã	Ä	Å	Ç	È	É	Ê	Ë	Ì	Í	Î	Ï	Ñ																																																																																																																																																																				
	Ò	Ó	Ô	Õ	Ö	Ù	Ú	Û	Ü	ß	à	á	â	ã	ä	å	ä																																																																																																																																																																				
	ä	ç	è	é	ê	ë	ì	í	î	ï	ò	ó	ô	õ	ö	ø	ö																																																																																																																																																																				
	ù	ú	û	ü	¿	¡	*	\	_	\$	'	^	#	:	:	:	:																																																																																																																																																																				
	0	1	2	3	4	5	6	7	8	9	%	.	,	:	:	:	:																																																																																																																																																																				
	?	!	()	[]	<	>	=	/	+	-	:	:	:	:	:																																																																																																																																																																				
	█ Lab Balance																																																																																																																																																																																				
Accept	Escape	Delete Letter	Cursor Left	Cursor Right																																																																																																																																																																																	

3.13.2. BAUD RATE

Option: 4800, 9600, 19200, 38400

Set the serial communication baud rate.

Balance Configuration				
Select the option to be modified.				
Balance Name:	Lab Balance			
Baud Rate:	9600			
Data Bit:	8 bits			
Parity:	N			
Stop Bit:	1			
Request Command:				
<div style="border: 1px solid black; padding: 2px; display: inline-block;"> 4800 9600 19200 38400 </div>				
Select	Escape		Test Balance	

3.13.3. DATA BITS

Option: 5, 6, 7, 8 bits

Set the number of data bits.

Balance Configuration				
Select the option to be modified.				
Balance Name:	Lab Balance			
Baud Rate:	9600			
Data Bit:	8 bits			
Parity:	N			
Stop Bit:	1			
Request Command:				
<div style="border: 1px solid black; padding: 2px; display: inline-block;"> 5 bits 6 bits 7 bits 8 bits </div>				
Select	Escape		Test Balance	

3.13.4. PARITY

Option: No Parity, Even, Odd

Set the parity of data packet.

Balance Configuration				
Select the option to be modified.				
Balance Name:	Lab Balance			
Baud Rate:	9600			
Data Bit:	8 bits			
Parity:	No Parity			
Stop Bit:				
Request Command:				
				No Parity Even Odd
Select	Escape		Test Balance	

3.13.5. STOP BIT

Option: 1 bit or 2 bits

Set the number of stop bits.

Balance Configuration				
Select the option to be modified.				
Balance Name:	Lab Balance			
Baud Rate:	9600			
Data Bit:	8 bits			
Parity:	No Parity			
Stop Bit:	1 bit			
Request Command:				
				1 bit 2 bits
Select	Escape		Test Balance	

3.15. RESET TO DEFAULT SETTINGS

Note: This will delete all user-defined methods and restore all manufacturer settings such as titrator configuration, standard method parameters, etc.



3.16. OPTIMIZE MEMORY SPACE

This screen allows the user to run a memory defragmentation utility to increase access speed to memory storage. Press

and then restart the titrator. Do not disconnect the power supply during this operation.

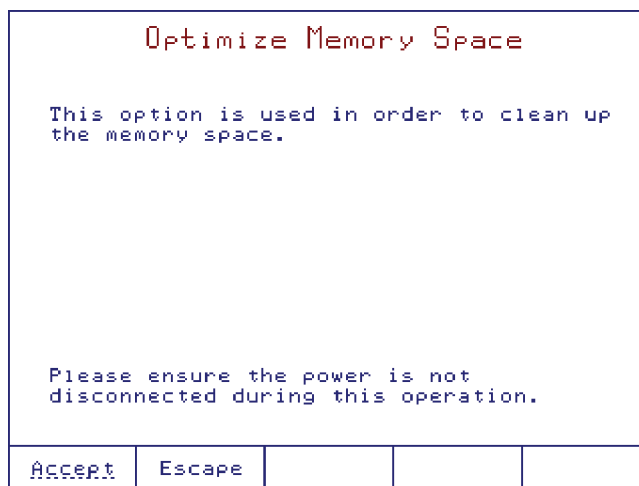

3.17. UPDATE SOFTWARE

This screen allows the user to update the titrator software from a USB storage device containing a software setup kit.

Update Software				
Current version:	HI931	v1.00		
New version:	HI931	v1.01		
Are you sure you want to update the current software with the new version?				
Accept	Escape	Refresh		

To update the software:

1. Copy the "Setup931" folder to a USB storage device.
2. Insert the USB storage device into the USB port.
3. Go to **General Options**, then **Update Software**. The titrator will display the current and new software versions.
4. Press . When prompted, remove the USB storage device and restart the titrator.

4. TITRATION METHODS

All parameters required to complete an analysis are grouped into a method.

The titrator is supplied with a pack of standard methods, these methods have been developed by Hanna Instruments and can be used to create user-defined methods.

Standard and user-defined methods can be upgraded, saved or deleted by connecting the titrator to a PC using the **HI900** PC application or a USB flash drive.

4.1. SELECTING METHODS

To select a method, press  from the main screen. A list of available methods will be displayed.

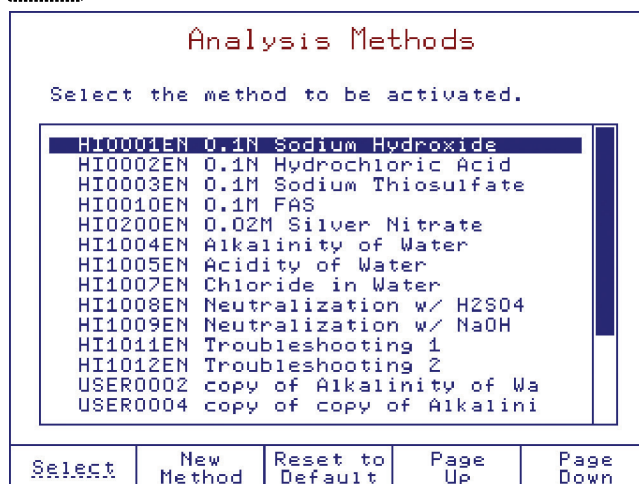

In the **Analysis Methods** screen, you can view the list of all available methods (standard and user-defined methods).

To select a method, highlight the method then press . The name of the selected method will be displayed on the main screen.

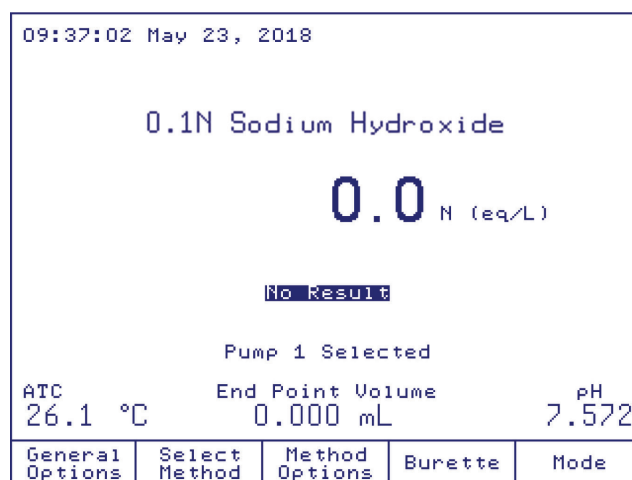

4.2. STANDARD METHODS

The standard methods are developed for the most common types of analysis and can be used as templates to create new user-defined methods.

Only specific method parameters can be modified by the use. See **4.5. METHOD OPTIONS** for more information.

4.2.1. UPGRADING STANDARD METHODS

To upgrade the titrator with new standard methods, follow the steps below:

From USB storage device:

1. Insert the USB storage device into the USB port, located on the right side of the titrator.
2. Press **General Options** from the main screen.
3. Using **▲** and **▼** keys, highlight *Restore from USB Storage Device* option and choose **Select**.
4. Using **<** and **>** keys, navigate through file types to find “standard method files”.
5. Press the **Copy File** or **Copy All** key to upgrade the titrator with the standard methods.
6. Press **Escape** to return to **General Options** screen.

From PC:

You can upgrade the titrator with standard methods from a PC using the **HI900** PC application. See [3.12. USB LINK WITH PC](#) for more information.

4.2.2. DELETING STANDARD METHODS

Standard methods can be removed from the titrator by following one of the procedures below.

From General Options Screen:

1. Using the **▲** and **▼** keys, highlight *Save to USB* option and press **Select**.
2. Using the **<** and **>** keys, navigate through the file types menu to find the list of “standard method files”.
3. Press the **Delete** or **Delete All** keys to remove unnecessary standard methods.
4. Press **Escape** to return to the **General Options** screen.

From PC:

The not required standard methods can be removed from the titrator using the **HI900** PC application. See [3.12. USB LINK WITH PC](#) for more information.

4.2.3. RESTORING THE STANDARD METHODS TO THE MANUFACTURER SETTINGS

You can restore the standard methods to the default settings by highlighting a standard method and pressing **Reset to Default**.

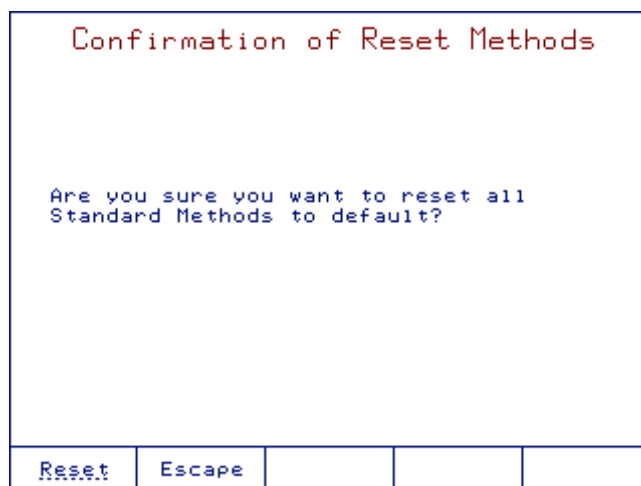





4.3. USER-DEFINED METHODS

User-defined methods are created by users, by modifying a standard method or previously created user-defined method. All method parameters can be modified to suit user-specific requirements.

4.3.1. CREATING USER-DEFINED METHODS



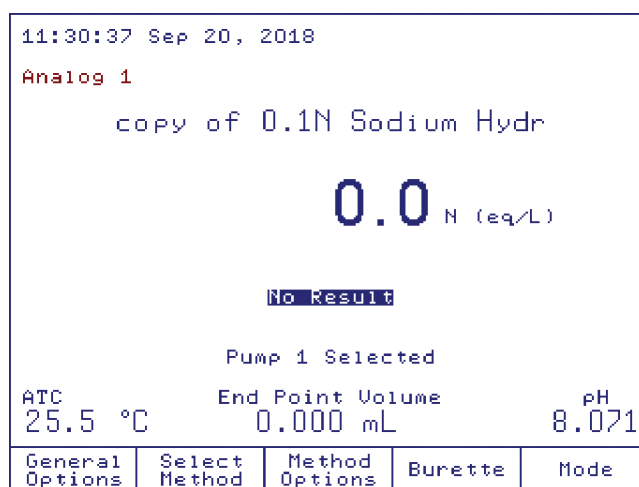

To create a new user-defined method, start from a standard or previously generated user-defined method and follow these steps:

1. Press  from the main screen.
2. Using the  and  keys, highlight an existing method from the method list.
3. Press . A new user-defined method will be generated.
4. Press  to activate the new method.





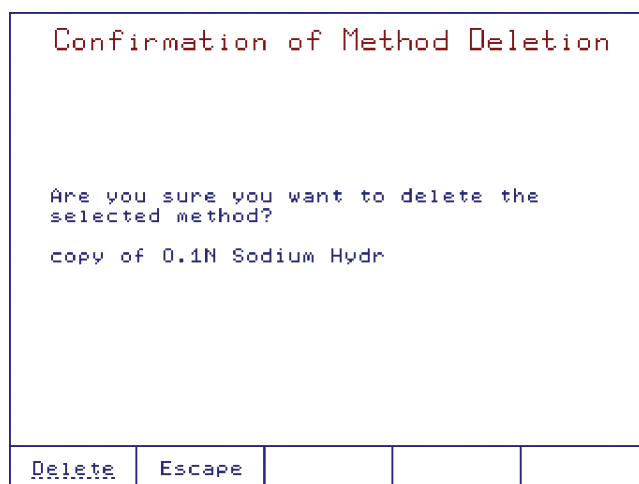

Note: The titrator can hold 100 methods (standard and user-defined). When the limit is reached, a warning message is displayed.

4.3.2. DELETING USER-DEFINED METHODS

1. To remove a user-defined method, press  from the main screen.
2. Highlight the user-defined method that you want to delete and press , a confirmation screen will appear.
3. Press  again to confirm, or press  to cancel the operation.



4.4. VIEWING / MODIFYING METHOD

To modify the method parameters, press  from the main screen. A list of all the parameters for the selected method will be displayed. Press the  and  keys to highlight the option you want to modify and choose .

View/Modify Method																															
Id: HI0001EN		Modified: 12:04 Sep 12, 2018																													
Select the option to be modified.																															
<table border="1"> <tr><td>Name:</td><td>0.1N Sodium Hydroxide</td></tr> <tr><td>Method Revision:</td><td>3.0</td></tr> <tr><td>Stirrer Configuration</td><td></td></tr> <tr><td>Titration pump:</td><td>Pump 1</td></tr> <tr><td>Dosing Type:</td><td>Dynamic</td></tr> <tr><td>End Point Mode:</td><td>pH 1EQ point,1st Der</td></tr> <tr><td>Recognition Options</td><td></td></tr> <tr><td>Pre-Titration Volume:</td><td>5.000 mL</td></tr> <tr><td>Pre-Titration Stir Time:</td><td>60 sec</td></tr> <tr><td>Measurement Mode:</td><td>Signal Stability</td></tr> <tr><td>Electrode Type:</td><td>pH</td></tr> <tr><td>Blank Option:</td><td>No Blank</td></tr> <tr><td>Calculations:</td><td>Stdz. Titrant by Weight</td></tr> <tr><td>Dilution Option:</td><td>Disabled</td></tr> </table>				Name:	0.1N Sodium Hydroxide	Method Revision:	3.0	Stirrer Configuration		Titration pump:	Pump 1	Dosing Type:	Dynamic	End Point Mode:	pH 1EQ point,1st Der	Recognition Options		Pre-Titration Volume:	5.000 mL	Pre-Titration Stir Time:	60 sec	Measurement Mode:	Signal Stability	Electrode Type:	pH	Blank Option:	No Blank	Calculations:	Stdz. Titrant by Weight	Dilution Option:	Disabled
Name:	0.1N Sodium Hydroxide																														
Method Revision:	3.0																														
Stirrer Configuration																															
Titration pump:	Pump 1																														
Dosing Type:	Dynamic																														
End Point Mode:	pH 1EQ point,1st Der																														
Recognition Options																															
Pre-Titration Volume:	5.000 mL																														
Pre-Titration Stir Time:	60 sec																														
Measurement Mode:	Signal Stability																														
Electrode Type:	pH																														
Blank Option:	No Blank																														
Calculations:	Stdz. Titrant by Weight																														
Dilution Option:	Disabled																														
Escape	Print Method	Page Up	Page Down																												

To exit the **View / Modify Method** screen, press the  key and highlight *Save Method* or *Exit Without Saving Method*.

Saving Method					
Select a menu option.					
<table border="1"> <tr><td>Save Method</td></tr> <tr><td>Exit Without Saving Method</td></tr> </table>				Save Method	Exit Without Saving Method
Save Method					
Exit Without Saving Method					
"Escape" - exits without saving method.					
Select	Escape				

 Saves modifications.

 Discards the changes.

4.5. METHOD OPTIONS

Note: Not all method options can be changed for standard methods.

4.5.1. NAME

Option: Up to 24 characters

Method Name				
Select the highlighted letter by using the arrow keys then press "Enter". Select the empty field for a space. Press Accept to save the entire name.				
<pre> A B C D E F G H I J K L M N O P Q R S T U V W X Y Z a b c d e f g h i j k l m n o p q r s t u v w x y Z A A Å Å Ä Ç È É Ê Ë Ì Í Î Ï Ñ O O O Ø Ù Ú Û Ü Õ Ö à á â ã ä å ç è é ê ë ì í ñ ò ó ô õ ö ø ù ú û ü ÿ ÿ ÿ ÿ ÿ ÿ ÿ ÿ ÿ ÿ 0 1 2 3 4 5 6 7 8 9 ¨ ¸ ¸ ¸ ¸ ¸ ? ! () [] < > = / + - </pre>				
copy of 0.1N Sodium Hydr				
Accept	Escape	Delete Letter	Cursor Left	Cursor Right

4.5.2. METHOD REVISION

Option: Up to 3 characters

Method Revision				
Select the highlighted letter by using the arrow keys then press <Enter>. Select the empty field for a space. The revision string format is "X.X".				
<pre> B C D E F G H I J K L M N O P Q R S T U V W X Y Z a b c d e f g h i j k l m n o p q r s t u v w x y z A A Å Å Ä Ç È É Ê Ë Ì Í Î Ï Ñ O O O Ø Ù Ú Û Ü Õ Ö à á â ã ä å ç è é ê ë ì í ñ ò ó ô õ ö ø ù ú û ü ÿ ÿ ÿ ÿ ÿ ÿ ÿ ÿ ÿ ÿ 0 1 2 3 4 5 6 7 8 9 ¨ ¸ ¸ ¸ ¸ ¸ . , ? ! () [] < > = + - * / \ _ ` ^ ' : </pre>				
1.0				
Accept	Escape	Delete Letter	Cursor Left	Cursor Right

4.5.3. STIRRER CONFIGURATION

Use the arrow keys to select the menu option.

Stirrer Configuration				
Select a menu option.				
Stirrer:		Stirrer 1		
Stirring Speed:		1400 RPM		
Select	Escape			

4.5.3.1. Stirrer

Option: Stirrer 1 or Disabled

Stirrer Configuration						
Select a menu option.						
Stirrer:		Stirrer 1				
Stirring Speed:		1400 RPM				
		<table border="1"> <tr> <td>Disabled</td> </tr> <tr> <td>Stirrer 1</td> </tr> </table>			Disabled	Stirrer 1
Disabled						
Stirrer 1						
Select	Escape					

4.5.3.2. Stirrer Speed

Option: 200 to 2500 RPM

Stirring Speed				
Enter the speed of the stirrer within below range.				
<div style="text-align: center;"> 1400 RPM </div>				
The range is from 200 to 2500 RPM.				
Accept	Escape	Delete Digit		

The stirrer will remain on for as long as the method is active. When the stirrer is running, the speed can be adjusted at any time by using the \triangle and ∇ keys.

4.5.4. PUMP CONFIGURATION

Option: Pump 1, Pump 2 (if installed)

View/Modify Method

Id: USER0010 Modified: 13:01 Jul 13, 2018
Select the option to be modified.

Name:	0.1N Sodium Hydroxide
Method Revision:	1.0
Stirrer Configuration	
Titrant pump:	Pump 1
Dosing Type:	
End Point Mode:	pH 1EQ point
Recognition Options	
Pre-Titration Volume:	
Pre-Titration Stir Time:	60 sec
Measurement Mode:	Signal Stability
Electrode Type:	pH
Blank Option:	No Blank
Calculations:	Stdz. Titrant by Weight
Dilution Option:	Disabled

Select	Escape	Print Method	Page Up	Page Down
--------	--------	--------------	---------	-----------

4.5.5. DOSING TYPE

Option: Linear Dosing or Dynamic Dosing

Dosing Type

Select the dosing type.

Linear Dosing
Dynamic Dosing

Select	Escape			
--------	--------	--	--	--

4.5.5.1. Linear Dosing

Linear dosing dispenses a pre-defined volume of titrant with every addition.

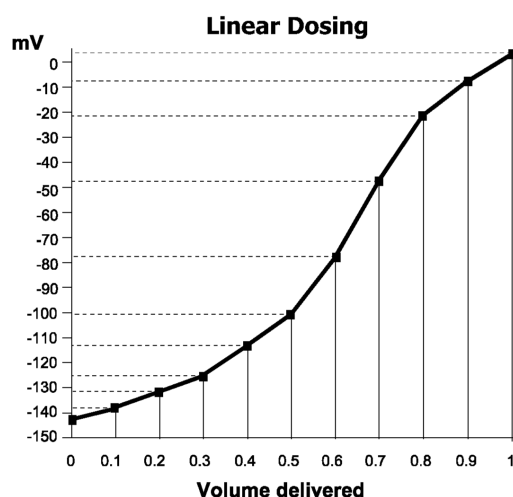

Linear dosing is recommended for titrations with a slower reaction rate, difficult nonaqueous titrations, and specific applications.

Note: For steep and normal titration curves, smaller volume increments are recommended, to obtain many points around the equivalence point. For flat titration curves, larger volume increments are recommended for equivalence point detection.

To set the dosing volume, select Linear Dosing and enter the optimum dose.

Dosing volume ranges are:

5 mL burette	0.001 to 4.750 mL
10 mL burette	0.001 to 9.500 mL
25 mL burette	0.005 to 23.750 mL
50 mL burette	0.005 to 47.500 mL

4.5.5.2. Dynamic Dosing

The titrator determines the titrant dose by trying to maintain a certain potential change (*delta E*) with each addition. After a titrant dose, if the potential change is lower than the set *delta E*, the next dose will be progressively increased until *max Vol* is attained. If the potential change is still lower than the set value, the titration will continue with *max Vol* doses. After a titrant dose, if the potential change is higher than the set *delta E*, the next dose will be progressively decreased until *min Vol* is attained. If the potential change is still higher than the set value, the titration will continue with *min Vol* doses. The titrant is added in volumes that depend on the proximity of the endpoint as shown in the graph below. Dynamic dosing allows for larger doses far from the endpoint, reducing the total titration time. Closer to the endpoint, smaller doses are made, providing more data and improved accuracy.

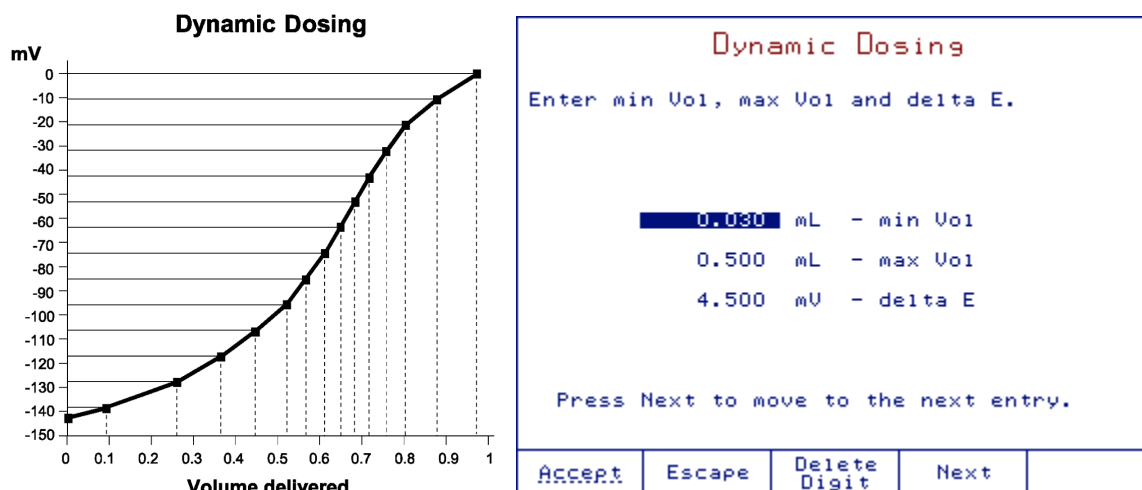

The following parameters must be set:

- min Vol** The smallest dose to be dispensed during a titration.
The *min Vol* must be greater than or equal to:
5 mL & 10 mL burette 0.001 mL
25 mL & 50 mL burette 0.005 mL
- max Vol** The largest dose to be dispensed during a titration.
The *max Vol* must be less than or equal to 4.000 mL.
- delta E** Sets the fixed potential jump that has to be achieved after each titrant dose.
The allowed range is between 0.1 and 99.999 mV.

Recommendations for dosing parameters:

For steep and normal titration curves the recommended settings are:

delta E 3.5 to 9 mV
min Vol 0.010 to 0.025 mL (25 mL burette)
max Vol 0.075 to 0.250 mL (25 mL burette)

For flat titration curves the recommended settings are:

delta E 10 to 15 mV
min Vol 0.050 to 0.150 mL (25 mL burette)
max Vol 0.400 to 0.600 mL (25 mL burette)

To achieve the highest levels of accuracy and reproducibility, it is recommended that 20 to 80% of the nominal burette volume used for each titration is consumed. If lower volumes of titrant are required, a smaller burette can be used.

4.5.6. ENDPOINT MODE

Option: Equivalence Endpoint (pH or mV) or Fixed Endpoint (pH or mV)

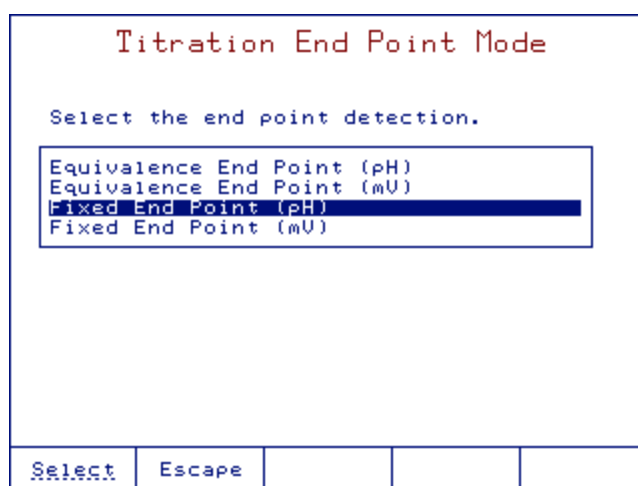
**4.5.6.1. Fixed Endpoint (pH or mV)****Fixed Endpoint (pH)**

Option: -2.000 to 20.000 pH

The titration is terminated when the preset pH value has been exceeded. The endpoint volume is a calculated value based on the dispensed volume when pH is under the preset value and the dispensed volume when pH exceeds the preset value.

Preset pH End Point				
Enter the end point pH value.				
8.600 pH				
The range is from -2.000 to 20.000 pH.				
Accept	Escape	Delete Digit		

Fixed Endpoint (mV)

Option: -2000.0 to 2000.0 mV

The endpoint detection algorithm is the same as for pH, but the threshold value is expressed in mV.

Preset mV End Point				
Enter the end point mV value.				
0.0 mV				
The range is from -2000.0 to 2000.0 mV.				
Accept	Escape	Delete Digit		

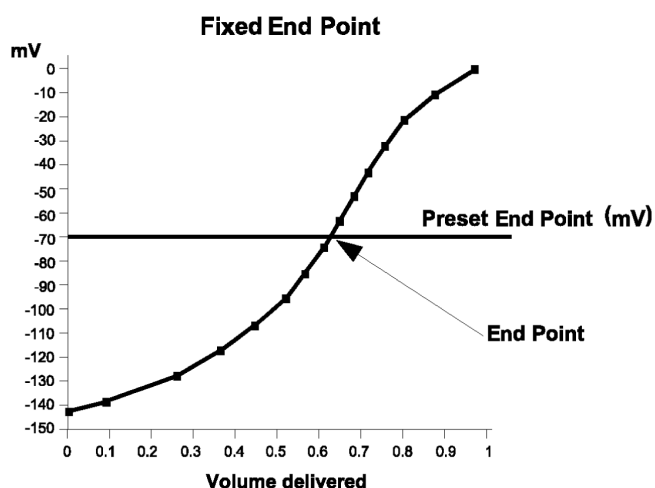

4.5.6.2. Equivalence Endpoint (pH or mV)

The titration is terminated when the equivalence point is detected (the point where the added quantity of titrant equals the quantity of analyte present in the sample).

Titration End Point Mode

Select the end point detection.

Equivalence End Point (pH)
Equivalence End Point (mV)
Fixed End Point (pH)
Fixed End Point (mV)

Select	Escape			
--------	--------	--	--	--

Endpoint Determination

Option: 1st derivative or 2nd derivative

End Point Determination

Select the end point determination.

1st derivative
2nd derivative

Select	Escape			
--------	--------	--	--	--

The equivalence point detection algorithm requires three additional titrant doses to be dispensed after the equivalence point is reached.

The reported endpoint volume is a calculated value based on a number of points around the equivalence point.

The potentiometric titration curve is the response in mV potential, or pH, between the indication of the electrode versus the volume of titrant added.

The inflection point of the titration curve is assumed to be the equivalence point of the chemical reaction.

For non-symmetric titration curves, the theoretical error can be reduced by using the dynamic dosing.

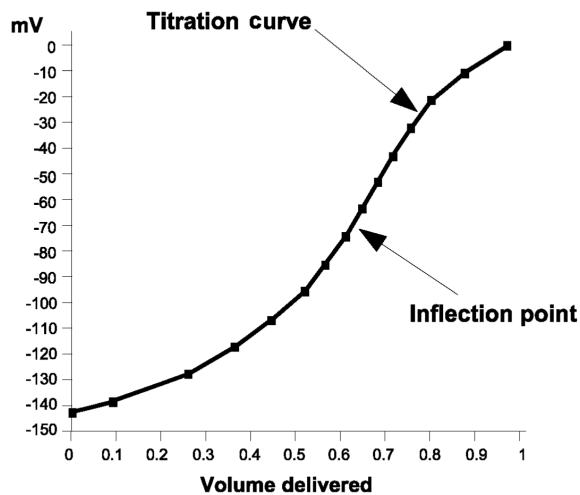

1st Derivative

When 1st derivative is used to recognize the equivalence point, the titration curve inflection point (EQP) is the point where the 1st derivative reaches its maximum value.

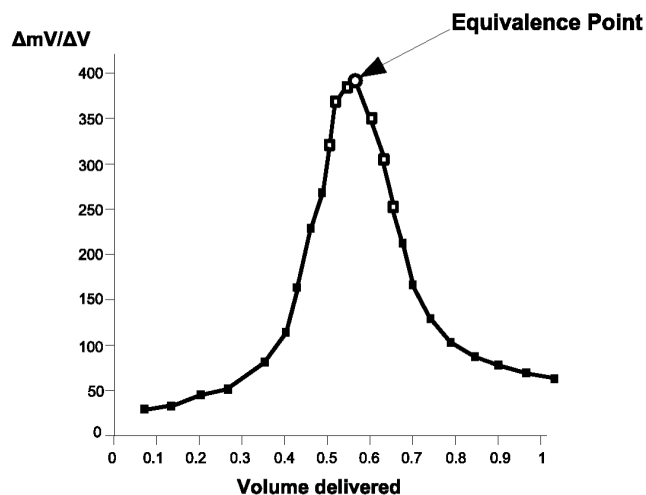

The detection algorithm looks for the maximum value of the 1st derivative. The 1st derivative must be greater than the threshold value at the maximum point. See [4.5.7. RECOGNITION OPTIONS \(EQUIVALENCE ENDPOINT ONLY\)](#) section for more information.

2nd Derivative

When 2nd derivative is used to recognize the equivalence point, the titration curve inflection point (EQP) is the point where the second derivative crosses zero.

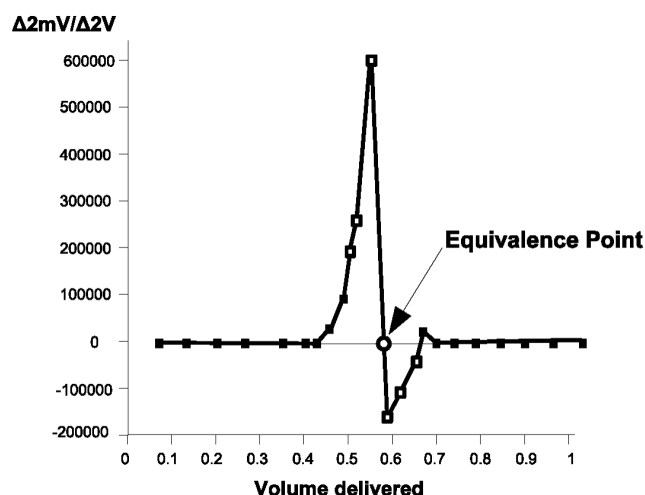

The detection algorithm looks for the point where the second derivative changes sign. The checked point, or 1st derivative, must be greater than the threshold value. See [4.5.7. RECOGNITION OPTIONS \(EQUIVALENCE ENDPOINT ONLY\)](#) section for more information.

4.5.7. RECOGNITION OPTIONS (EQUIVALENCE ENDPOINT ONLY)

The **Recognition Options** screen is a set of parameters used to avoid false detection of the equivalence point due to the chemical system (titrant / sample species and concentrations) and / or electrode response.

Recognition Options

Select the options for equivalence point recognition.

Threshold	500 mV/mL
Range	NO
Filtered Derivatives	NO

Select	Escape			
--------	--------	--	--	--

4.5.7.1. Threshold

Option: 1 to 9999 mV / mL

This parameter must be set by the user according to the analysis.

The threshold represents the absolute value of the 1st derivative, expressed in mV / mL, which the detection algorithm does not search for the equivalence point.

Threshold				
Enter the threshold for equivalence point detection.				
EQ 1 Threshold: 500 mV/mL				
Recommended value is between: 1 and 450 mV/mL for FLAT Curve, 450 and 1800 mV/mL for NORMAL Curve, 1800 and 9999 mV/mL for STEEP Curve.				
Accept	Escape	Delete Digit	Next Threshold	

The recommended value is 40% of the absolute value of the 1st derivative.

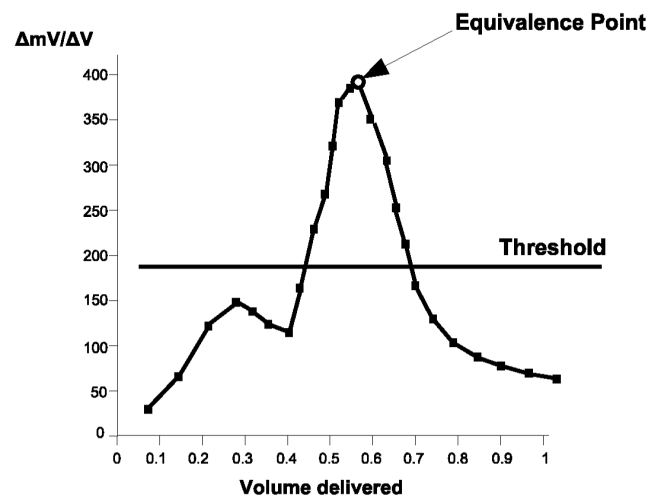

Depending on the titration curve profile, the following guide can be used:

Flat	1 to 450
Normal	50 to 1800
Steep	1800 to 9999

4.5.7.2. Range

Option: -2.000 to 20.000 pH or -2000.0 to 2000.0 mV

Range is an optional feature for equivalence point recognition.

Select Yes in the Range Options screen to enable.

The titrator will only look for an equivalence point between the set values.

Range Limits

Enter Limit 1 and Limit 2 for range.

-2.0 mV - EQ 1 Limit1
20 mV - EQ 1 Limit2

Press <Next EQ Range> for the next range.

Accept	Escape	Delete Digit	Next Limit	Next EQ Range
--------	--------	--------------	------------	---------------

The Limit 2 value must not be equal to the Limit 1 value.

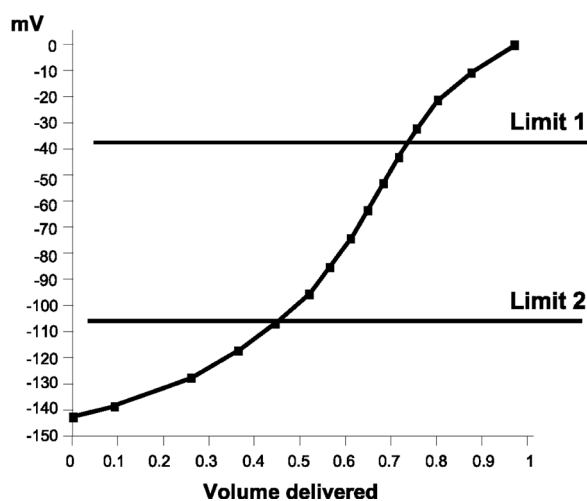

4.5.7.3. Filtered Derivatives

Option: Yes or No

This option adds a filtering procedure in the 1st and 2nd derivative computation algorithm that reduces the influence of pH or mV noise.

Select Yes in the Filtered Derivative Option to enable.

Filtered Derivatives Option

Select option for filtered derivatives.

NO
YES

"NO" - without filtered derivatives.
 "YES" - with filtered derivatives.

Select	Escape			
--------	--------	--	--	--

Noise can be due to:

- Chemical system properties (sample, titrant, solvent), such as slow chemical reactions or unbuffered samples such as wastewater, tap water, wine
- Electrode response
- Incorrect method parameters settings such as *Signal Stability*, *Stirring Speed*, etc.
- Insufficient titrant additions

Note: A shift in the endpoint volume by 1 or 2 doses may be seen due to filtering.

4.5.8. PRE-TITRATION VOLUME

During a titration, the equivalence point is reached after many titrant doses. These doses take up extra time while having no relevance for equivalence point detection.

Pre-titration volume adds a large initial dose to jump directly to the proximity of the equivalence point.

This first dose occurs after the pre-titration stir time is completed.

The ranges for pre-titration volumes are shown below:

5 mL burette	0.001 to 4.750 mL
10 mL burette	0.001 to 9.500 mL
25 mL burette	0.005 to 23.750 mL
50 mL burette	0.005 to 47.500 mL

Pre-Titration Volume

Enter the initial titrant volume to be dispensed.

9.000 mL

Press Help to view the valid ranges for the pre-titration volume.

Accept	Escape	Delete Digit		
--------	--------	--------------	--	--

To disable a pre-titration volume, enter 0.000 mL.

Note: A pre-titration volume is highly recommended whenever possible. Fewer doses will considerably shorten the overall titration duration.

4.5.9. PRE-TITRATION STIR TIME

Option: 0 to 180 seconds

When enabled, the sample is mixed for a set period of time before any titrant is added. This allows the sample to become homogeneous.

```
Pre-Titration Stir Time
Enter the initial mixing time prior to
the start of the titration.

10 seconds

The range is from 0 to 180 seconds.

Accept  Escape  Delete
Digit
```

Pre-titration stir time is disabled if 0 seconds is entered.

4.5.10. MEASUREMENT MODE

Option: Signal Stability or Timed Increment

During titration, the acquisition of the potential (mV) value of the solution can be done by using either *Signal Stability* or *Timed Increment* option.

```
Measurement Mode
Select the measurement mode.

Signal Stability
Timed Increment

Select  Escape
```

4.5.10.1. Signal Stability

When *Signal Stability* is selected, the titrator acquires the potential (mV) only when stable conditions are reached. The principles of signal stability are plotted below:

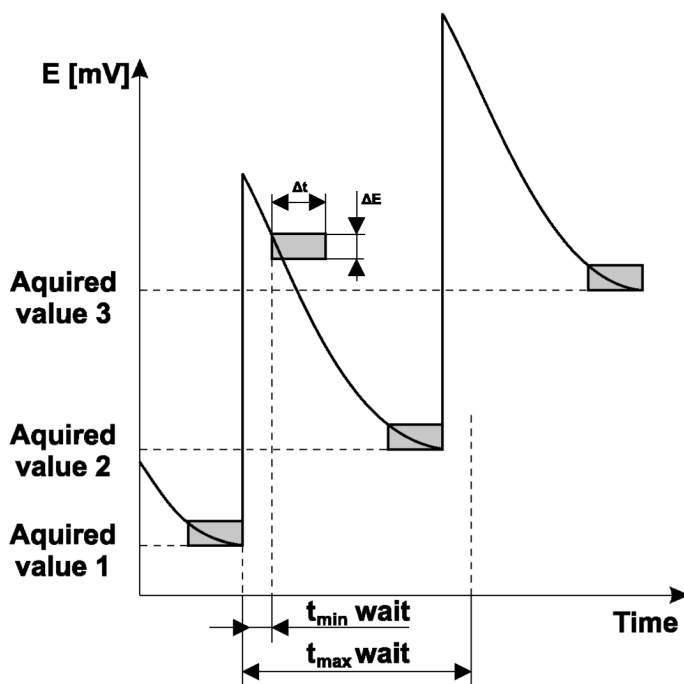

The signal stability window (condition) represents the time interval (Δt) during which the potential measured in solution (mV) is confined inside the potential interval (ΔE).

The new signal value is acquired if the stability condition is reached after the minimum (t_{\min}) wait time.

If the stability condition is not reached and the maximum (t_{\max}) wait time has elapsed, the potential is acquired.

Signal Stability

Enter mV variation (delta E) in the time interval (delta t) min and max wait time period to the next sample measurement.

0.3 mV - delta E
 2 seconds - delta t
 3 seconds - t min wait
 30 seconds - t max wait

Accept	Escape	Delete Digit	Next	
--------	--------	--------------	------	--

delta E Maximum change in potential during *delta t*

The range is from 0.1 to 99.9 mV.

delta t The time interval during which the potential is measured.

The range is from 1 to 10 seconds.

t min wait The minimum elapsed time before a stability check. This is also the minimum elapsed time between two doses.

The range is from 2 seconds to *t max wait* time.

t max wait The maximum elapsed time between two successive doses. If the *t max wait* has elapsed, a new dose is added even if the signal stability condition is not reached.

The range is from t_{\min} wait time to 180 seconds.

4.5.10.2. Timed Increment

Option: 2 to 180 seconds

When *Timed Increment* is selected, the titrator acquires the potential (mV) at a fixed time interval (no signal stability check).

The time period between two acquisitions must be set according to the reaction and the response time of the electrode.

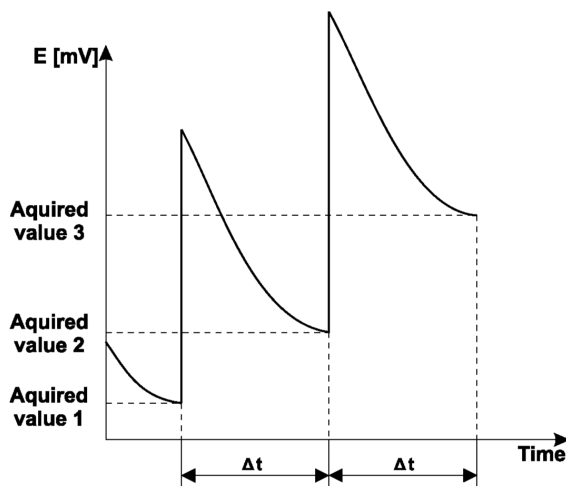

Timed Increment

Enter the period of time to wait until the next dose.

5 seconds

The range is from 2 to 180 seconds.

Accept	Escape	Delete Digit		
--------	--------	-----------------	--	--

4.5.13. CALCULATIONS

The final result is calculated using the endpoint volume (titrant volume at the equivalence point or at the fixed endpoint), and a formula selected by the user.

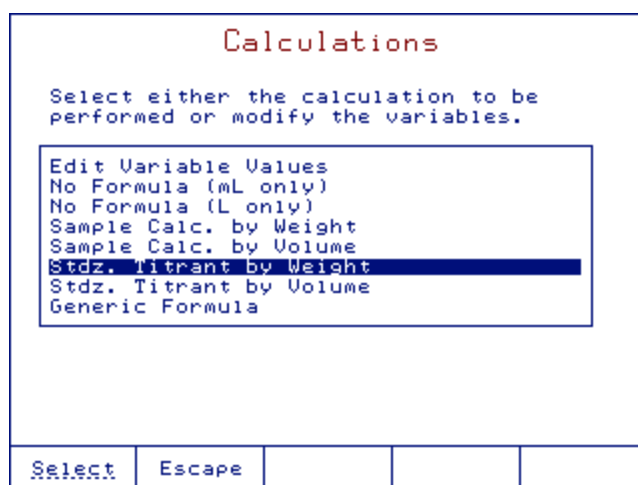

4.5.13.1. Standard Titration Calculations

4.5.13.1.1. Edit Variable Values

Edit the variables in a previously selected calculation.

For each formula, selected variables can be changed.

4.5.13.1.2. No Formula (mL only)

Only the volume of titrant (mL) required to reach the endpoint will be displayed.

4.5.13.1.3. No Formula (L only)

Only the volume of titrant (L) required to reach the endpoint is displayed.

4.5.13.1.4. Sample Calculations by Weight

Titrant units

Option: M (mol / L), N (eq / L), g / L, mg / L

Final result units

Option: ppt (g / kg), ppm (mg / kg), ppb (μg / kg), % (g / 100 g), mg / g, mg / kg, mol / kg, mmol / g, eq / kg, meq / kg

This calculation is used when the concentration of an analyte is determined by the weight of the sample. The results are based on the initial sample weight (in grams).

The titrator will calculate the results based on the titrant and sample units selected.

A formula example is shown below using M (mol / L) as the titrant unit and ppt (g / kg) as the final result unit:

Variables can be set according to the amount of sample and titrant used.

Calculating Sample Concentration

M (mol/L) --> ppt (g/kg)

The calculation is:

$$\frac{U \times \frac{\text{mol}}{\text{L}} \times \frac{\text{mol}}{\text{mol}} \times \frac{\text{g}}{\text{mol}}}{\frac{\text{g}}{\text{kg}} \times 1000\text{g}}$$

Select the variables to change value.
U = volume dispensed in liters.

1.000 mol/L -> titrant conc.
1.000 mol/mol -> (sample/titrant)
1.000 g/mol -> mw of sample
1.000 g -> sample weight

Select	Escape	Save / Exit		
--------	--------	----------------	--	--

4.5.13.1.5. Sample Calculations by Volume

Titrant Units

Option: M (mol /L), N (eq / L), g / L, mg / L

Final Result Units

Option: ppt (g/L), ppm (mg/L), ppb (µg/L), M (mol/L), N (eq/L), mg/L, µg/L, mmol/L, mg/mL, mg/100 mL, g / 100 mL, eq / L, meq / L

This calculation is used when the concentration of an analyte is determined in terms of the volume of sample. The results are based on the initial sample volume (in milliliters).

The titrator will calculate the results based on the selected units.

Calculating Sample Concentration

N (eq/L) --> ppt (g/L)

The calculation is:

$$\frac{U \times \frac{\text{eq}}{\text{L}} \times \frac{\text{mol}}{\text{eq}} \times \frac{\text{g}}{\text{mol}}}{\frac{\text{mL}}{\text{L}} \times 1000\text{mL}}$$

Select the variables to change value.

1.000 eq/L -> titrant conc.
1.000 mol/eq -> (sample/titrant)
1.000 g/mol -> mw of sample
1.000 mL -> sample volume

Select	Escape	Save / Exit		
--------	--------	----------------	--	--

A formula example is shown below using N (eq / L) as the titrant units and g / L as the final result units. Variables can be set according to the amount of sample and titrant used.

Calculating Sample Concentration

M (mol/L) --> mol/L

The calculation is:

$$\frac{U \times \frac{\text{mol}}{\text{L}} \times \frac{\text{mol}}{\text{mol}}}{\text{mL} \times \frac{\text{L}}{1000\text{mL}}}$$

Select the variables to change value.
U = volume dispensed in liters.

1.000 mol/L -> titrant conc.
1.000 mol/mol -> (sample/titrant)
100.00 mL -> sample volume

Select	Escape	Save / Exit		
--------	--------	----------------	--	--

4.5.13.1.6. Standardize Titrant by Weight

Option: M (mol /L), N (eq / L), g / L, mg / L

This calculation is used when the concentration of the titrant is determined using a solid standard. Determination of the titrant concentration is based on the primary standard weight (in grams).

The calculation is based on the selected titrant unit. If the titrant unit is M (mol / L), the formula used to calculate the result is displayed below.

Calculating Titrant Concentration

The titrant concentration unit is M (mol/L).

The calculation is:

$$\frac{g \times \frac{\text{mol}}{\text{g}} \times \frac{\text{mol}}{\text{mol}}}{U}$$

Select the variables to change value.
U = volume dispensed in liters.

0.200 g -> standard weight
204.23 g/mol -> mw of standard
1.000 mol/mol -> (titrant/standard)

Select	Escape	Save / Exit		
--------	--------	----------------	--	--

4.5.13.1.7. Standardize Titrant by Volume

Option: M (mol /L), N (eq / L), g / L, mg / L

This calculation is used when the concentration of the titrant is determined using a primary standard solution. Determination of the titrant concentration is based on the primary standard volume (in milliliters).

The calculation is based on the selected titrant unit. If the titrant unit is N (eq / L), the formula used to calculate the result is displayed below.

Calculating Titrant Concentration

The titrant concentration unit is N (eq/L).

The calculation is:

$$\frac{\text{mL} \times \frac{\text{L}}{1000\text{mL}} \times \frac{\text{eq}}{\text{L}}}{V}$$

Select the variables to change value.
V = volume dispensed in liters.

1.684 mL -> standard volume

2.375 eq/L -> standard conc.

Select	Escape	Save / Exit	
--------	--------	----------------	--

4.5.13.1.8. Generic Formula

Final results units:

Option: ppt (g / kg), ppt (g / L), ppm (mg / kg), ppm (mg / L), ppb (μg / kg), ppb (μg / L), % (g / 100 g), M (mol/L), mg/g, N (eq/L), g/L, mg/kg, mg/L, mol/kg, μg /L, mol/L, mmol/g, eq/kg, mmol/L, meq/kg, mg / mL, mg / 100 mL, g / 100 mL, eq / L, meq / L, no unit

Users can define their own calculation formula based on the final result units in a solid or liquid sample.

The titrator will calculate the results based on the selected unit.

The formula can be either for titrant standardization or sample analysis.

Calculating Sample Concentration

Final unit is mg/L.

The calculation is:

$$\frac{C \times U \times F1 \times F2 \times F3}{S}$$

Select the variables to change value.
U = volume dispensed in liters.

1.000 C -> (titrant conc.)

1.000 F1 -> (general factor)

1.000 F2 -> (general factor)

1.000 F3 -> (general factor)

Select	Escape	Save / Exit	
--------	--------	----------------	--

- C the concentration of the titrant
- F1, F2, F3 general factor
- S sample size, in grams or milliliters
- V the volume delivered, in liters, to reach the endpoint

General factors**Weight conversion** mol / L, eq / L, g / L, mg / L**Reaction ratio** mol / mol, mol / eq, eq / mol**Unit conversion** L to mL, g to mg**Weight conversion** kg, g, mg, μg , mole, mmole**4.5.14. DILUTION OPTION****Option: Enabled or Disabled**

When the initial sample is diluted, a titration is made with an aliquot of the diluted sample, dilution calculations can be used. The calculations are based on the original sample weight or volume in order to express the results for the initial sample.

Dilution Parameters										
Select the option.										
<table border="1"> <tr> <td>Final Dilution Volume:</td> <td>100.000 mL</td> </tr> <tr> <td>Aliquot Volume:</td> <td>10.000 mL</td> </tr> <tr> <td>Analyte size to be diluted:</td> <td>1.0000 mL</td> </tr> </table>					Final Dilution Volume:	100.000 mL	Aliquot Volume:	10.000 mL	Analyte size to be diluted:	1.0000 mL
Final Dilution Volume:	100.000 mL									
Aliquot Volume:	10.000 mL									
Analyte size to be diluted:	1.0000 mL									
Select	Escape									

Final Dilution Volume The volume of the sample after dilution**Aliquot Volume** Volume of sample taken from the dilution for titration**Analyte size to be diluted** The initial sample weight or volume**4.5.15. TITRANT NAME****Option: Up to 15 characters**

Titrant Name																																																																																																																																																													
Select the highlighted letter by using the arrow keys then press "Enter". Select the empty field for a space. Press Accept to save the entered text.																																																																																																																																																													
<table border="1"> <tr> <td>█</td> <td>A</td> <td>B</td> <td>C</td> <td>D</td> <td>E</td> <td>F</td> <td>G</td> <td>H</td> <td>I</td> <td>J</td> <td>K</td> <td>L</td> </tr> <tr> <td></td> <td>M</td> <td>N</td> <td>O</td> <td>P</td> <td>Q</td> <td>R</td> <td>S</td> <td>T</td> <td>U</td> <td>V</td> <td>W</td> <td>X</td> <td>Y</td> </tr> <tr> <td></td> <td>Z</td> <td>a</td> <td>b</td> <td>c</td> <td>d</td> <td>e</td> <td>f</td> <td>g</td> <td>h</td> <td>i</td> <td>j</td> <td>k</td> <td>l</td> </tr> <tr> <td></td> <td>m</td> <td>n</td> <td>o</td> <td>p</td> <td>q</td> <td>r</td> <td>s</td> <td>t</td> <td>u</td> <td>v</td> <td>w</td> <td>x</td> <td>y</td> </tr> <tr> <td></td> <td>z</td> <td>À</td> <td>Á</td> <td>Â</td> <td>Ã</td> <td>Ä</td> <td>Å</td> <td>Ç</td> <td>È</td> <td>É</td> <td>Ê</td> <td>Ë</td> <td>Ì</td> </tr> <tr> <td></td> <td>Î</td> <td>Ï</td> <td>Ñ</td> <td>Ò</td> <td>Ó</td> <td>Ô</td> <td>Õ</td> <td>Ö</td> <td>Ø</td> <td>à</td> <td>á</td> <td>â</td> <td>ã</td> </tr> <tr> <td></td> <td>ä</td> <td>å</td> <td>ç</td> <td>è</td> <td>é</td> <td>ê</td> <td>ë</td> <td>ì</td> <td>í</td> <td>î</td> <td>ï</td> <td>ò</td> <td>ó</td> </tr> <tr> <td></td> <td>ô</td> <td>õ</td> <td>ö</td> <td>ø</td> <td>ù</td> <td>ú</td> <td>û</td> <td>ü</td> <td>ÿ</td> <td>¸</td> <td>¸</td> <td>¸</td> <td>¸</td> </tr> <tr> <td></td> <td>0</td> <td>1</td> <td>2</td> <td>3</td> <td>4</td> <td>5</td> <td>6</td> <td>7</td> <td>8</td> <td>9</td> <td>×</td> <td>.</td> <td>,</td> </tr> <tr> <td></td> <td>?</td> <td>!</td> <td>(</td> <td>)</td> <td>[</td> <td>]</td> <td><</td> <td>></td> <td>=</td> <td>/</td> <td>+</td> <td>-</td> <td></td> </tr> <tr> <td></td> <td colspan="13">0.1N NaOH</td> </tr> </table>					█	A	B	C	D	E	F	G	H	I	J	K	L		M	N	O	P	Q	R	S	T	U	V	W	X	Y		Z	a	b	c	d	e	f	g	h	i	j	k	l		m	n	o	p	q	r	s	t	u	v	w	x	y		z	À	Á	Â	Ã	Ä	Å	Ç	È	É	Ê	Ë	Ì		Î	Ï	Ñ	Ò	Ó	Ô	Õ	Ö	Ø	à	á	â	ã		ä	å	ç	è	é	ê	ë	ì	í	î	ï	ò	ó		ô	õ	ö	ø	ù	ú	û	ü	ÿ	¸	¸	¸	¸		0	1	2	3	4	5	6	7	8	9	×	.	,		?	!	()	[]	<	>	=	/	+	-			0.1N NaOH												
█	A	B	C	D	E	F	G	H	I	J	K	L																																																																																																																																																	
	M	N	O	P	Q	R	S	T	U	V	W	X	Y																																																																																																																																																
	Z	a	b	c	d	e	f	g	h	i	j	k	l																																																																																																																																																
	m	n	o	p	q	r	s	t	u	v	w	x	y																																																																																																																																																
	z	À	Á	Â	Ã	Ä	Å	Ç	È	É	Ê	Ë	Ì																																																																																																																																																
	Î	Ï	Ñ	Ò	Ó	Ô	Õ	Ö	Ø	à	á	â	ã																																																																																																																																																
	ä	å	ç	è	é	ê	ë	ì	í	î	ï	ò	ó																																																																																																																																																
	ô	õ	ö	ø	ù	ú	û	ü	ÿ	¸	¸	¸	¸																																																																																																																																																
	0	1	2	3	4	5	6	7	8	9	×	.	,																																																																																																																																																
	?	!	()	[]	<	>	=	/	+	-																																																																																																																																																	
	0.1N NaOH																																																																																																																																																												
Accept	Escape	Delete Letter	Cursor Left	Cursor Right																																																																																																																																																									

4.5.16. TITRANT CONCENTRATION

Enter the concentration of the titrant to be used. When determining the titrant concentration, only the concentration unit is displayed.

Titrant Concentration				
Enter the titrant concentration.				
0.10123 M (mol/L)				
Accept	Escape	Delete Digit		Exponent

4.5.17. ANALYTE SIZE

Option: 0.001 to 250.0

Enter the size of the sample (for sample-concentration determination) or standard (for titrant-concentration determination).

Sample Volume				
Enter the initial sample volume in milliliters.				
1.0000 mL				
This volume will be used when fixed sample size is selected.				
Accept	Escape	Delete Digit		Exponent

4.5.18. ANALYTE ENTRY

Option: Fixed or Manual

Analyte Entry						
Select the entry mode of analyte.						
<table border="1"> <tr> <td>Fixed Weight or Volume</td> </tr> <tr> <td>Manual Weight or Volume</td> </tr> </table>					Fixed Weight or Volume	Manual Weight or Volume
Fixed Weight or Volume						
Manual Weight or Volume						
Verify the correct formula is being used, i.e. weight or volume analyte type.						
Select	Escape					

Fixed Weight or Volume

For each titration will use a set weight or volume in the calculations.

Manual Weight or Volume

For each titration the exact weight or volume can be entered at the beginning of each titration.

4.5.19. MAXIMUM TITRANT VOLUME

Option: 0.100 to 100.000 mL

The maximum titrant volume used in the titration must be set according to the analysis.

If the titration endpoint (fixed or equivalence point) is not reached, the titration will be terminated after the maximum titrant volume has been dispensed. The error message "Limits Exceeded" will appear on the display.

Maximum Titrant Volume					
Enter the maximum titrant volume to be dispensed.					
<table border="1"> <tr> <td>15.000 mL</td> </tr> </table>					15.000 mL
15.000 mL					
Recommend the total volume of the burette.					
Accept	Escape	Delete Digit			

4.5.20. POTENTIAL RANGE

Option: -2000.0 to 2000.0 mV

The input potential range can be set by the user. The titration will be terminated and an error message will appear if the potential is outside these limits.

These limits provide protection against a titration that does not generate an endpoint due to potential over-range.

Potential Range				
Enter the upper and lower potential.				
2000.0 mV - Upper Limit				
-2000.0 mV - Lower Limit				
Press Next to move to the next entry.				
Accept	Escape	Delete Digit	Next	

4.5.21. VOLUME / FLOW RATE

The flow rate for the dosing system can be set by the user in an interval of 0.3 to 2 times the burette volume:

5 mL burette 0.3 to 10 mL/min

10 mL burette 0.3 to 20 mL/min

25 mL burette 0.3 to 50 mL/min

50 mL burette 0.3 to 100 mL/min

The flow rate is set for all burette operations.

Flow Rate				
Enter the titrant/reagent flow rate.				
50.0 mL/min				
The range is from 0.3 to twice the total volume of the burette.				
Accept	Escape	Delete Digit		

Note: The titrator will automatically detect the burette size and display the correct high limit volume.

4.5.22. SIGNAL AVERAGING

Option: 1, 2, 3, 4 readings

This option enables filtering on the mV / pH reading.

If 1 Reading is selected, the filtering is disabled. The titrator will take the last reading and place it into a "moving window" along with the last 2, 3 or 4 readings (depending on the selected option). The average of those readings is displayed and used for calculations.

Averaging more readings is helpful when a noisy signal is received from the electrode.

```

View/Modify Method
Id: USER0001    Modified: 14:39 Jun 28, 2018
Select the option to be modified.

Measurement Mode:  Signal Stability
Electrode Type:    pH
Blank Option:      No Blank
Calculations:      Sample Calc. by Volume
Dilution Option:  Disabled
Titrant Name:      0.1N NaOH
Titrant Conc.:    1.0
Analyte Size:
Analyte Entry:
Maximum Titrant Volume:
Potential Range:  -2000.0
Volume/Flow Rate: 25 mL
Signal Averaging:  1 Reading
Significant Figures:  XXXXX

Select  Escape  Print Method  Page Up  Page Down
  
```

4.5.23. SIGNIFICANT FIGURES

Option: Two (XX), Three (XXX), Four (XXXX) or Five (XXXXX)

This option allows you to set the format for displaying the final titration result.

```

View/Modify Method
Id: USER0005    Modified: 10:18 May 23, 2018
Select the option to be modified.

Pre-Titration Stir Time: 60 sec
Measurement Mode:  Signal Stability
Electrode Type:    pH
Blank Option:      No Blank
Calculations:      Stdz. Titrant by Weight
Dilution Option:  Disabled
Titrant Name:      0.1N NaOH
Titrant Conc.:
Analyte Size:      0
Analyte Entry:
Maximum Titrant Volume: 15
Potential Range:  -2000.0 to 20
Volume/Flow Rate:  25 mL / 50.0
Signal Averaging:  1
Significant Figures:  XXXXX

Select  Escape  Print Method  Page Up  Page Down
  
```

4.6. PRINTING

To print method parameters, press Method Options from the main screen.

Press Print Method and wait a few seconds until the printer completes the job.

If no printer is connected to the dedicated socket, or if the printer is offline, an error message will appear on the display.

See [10.2.1. CONNECTING TO A PRINTER](#) section for details on connecting a printer to the titrator.

5. TITRATION MODE

5.1. RUNNING A TITRATION

Before beginning a titration, make sure that the following conditions are met:

- At least one pump is properly installed.
- A burette is inserted in the pump and filled with titrant.
- The aspiration tube is inserted in the titrant bottle and primed. The dispensing tube is over the titration beaker.
- The standard or sample has been carefully weighed / measured into the beaker.
- The electrode(s) and the temperature probe are submersed in the beaker.
- The desired method is selected and the parameters are set to the optimal values.

5.1.1. STARTING A TITRATION

To start a new analysis, press  from the main screen.

When an analysis begins:

- The stirrer will turn on, if enabled. See [4.5.3. STIRRER CONFIGURATION](#) section for more information.
- The pre-titration volume will be dispensed, if enabled. See [4.5.8. PRE-TITRATION VOLUME](#) section for more information.
- After the pre-titration volume is added the pre-titration stir time starts, if enabled. See [4.5.9. PRE-TITRATION STIR TIME](#) section for more information.
- The titrator will start the analysis and continue to deliver titrant until the endpoint is detected or the titration is terminated.

5.1.2. SUSPENDING A TITRATION

While a titration or analysis is in progress, you can temporarily stop it by pressing . This will stop the dosing pump if it is running.

To continue the titration or analysis press .

5.1.3. VIEWING THE TITRATION CURVE

During a titration, the potentiometric curve and the derivative curve (equivalence point only) can be displayed on the **Titration Graph** screen by pressing .

The potentiometric curve and the derivative curve are scaled to fit simultaneously inside the display.

When a titration endpoint is successfully detected, the volume is displayed on the graph and marked with an "x".

The contents of the graph as related to an endpoint type are as follows:

Equivalence endpoint (pH)	The pH readings and the selected derivative vs. volume of titrant are displayed (see Figure 1).
Equivalence endpoint (mV)	The mV readings and the selected derivative vs. volume of titrant are displayed (see Figure 2).
Fixed endpoint (pH)	The pH readings vs. volume of titrant are displayed (see Figure 3).
Fixed endpoint (mV)	The mV readings vs. volume of titrant are displayed (see Figure 4).

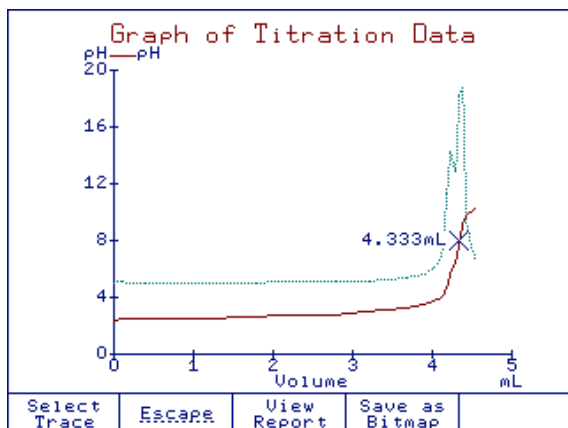

Figure 1 Equivalence endpoint (pH)

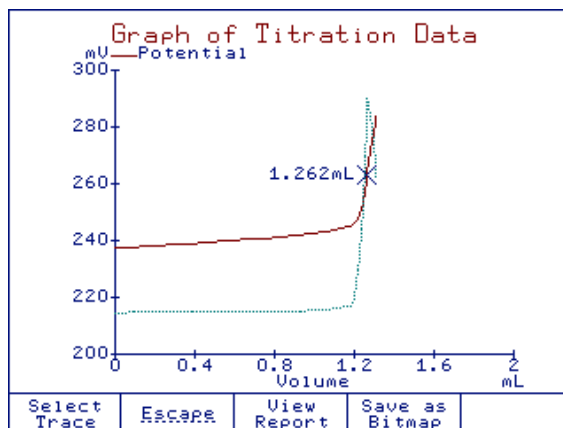

Figure 2 Equivalence endpoint (mV)

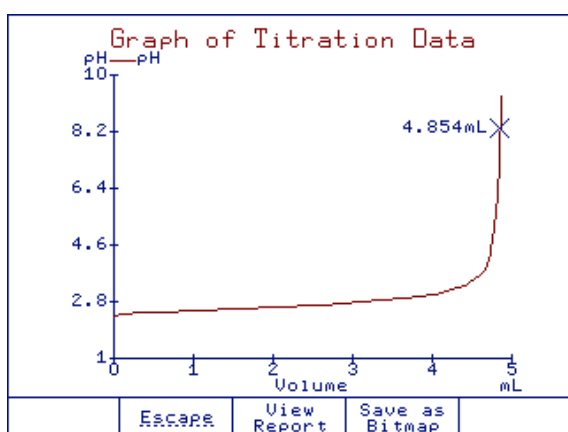

Figure 3 Fixed endpoint (pH)

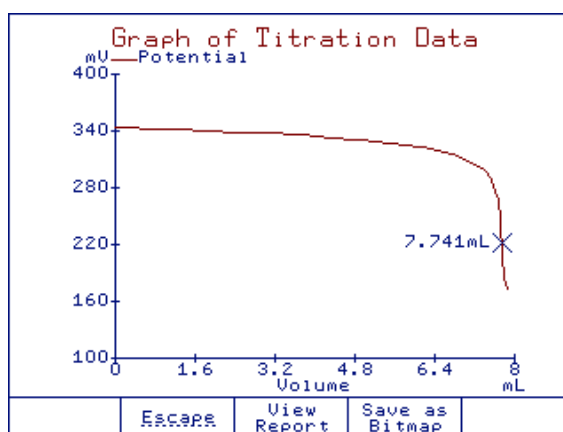

Figure 4 Fixed endpoint (mV)

Select Trace	Changes the y-axis from the pH (mV) reading to the derivate value (equivalence point titrations only).
Save as Bitmap	Saves the graph as a bitmap (available when titration is complete).

5.2. STOPPING A TITRATION

The titration or analysis is terminated when one of the following conditions is met:

Titration completed

This is the only mode with valid final result values. The endpoint or stable reading was successfully detected, the final results will be displayed.

Manually terminated

The current titration or analysis was terminated by the user before the endpoint was detected.

Limits exceeded

The maximum titrant volume was delivered without reaching the endpoint. An error message is displayed on the screen.

Critical error

A critical error occurred and the titration was stopped. These errors are typically related to the dosing system. An error message is displayed on the screen.

Potential out of range

The measured values from the electrode are outside the potential range. An error message is displayed on the screen.

6. pH MODE

By pressing from the main screen, the titrator can be switched to **Titration**, **pH**, **mV** or **ISE** modes.

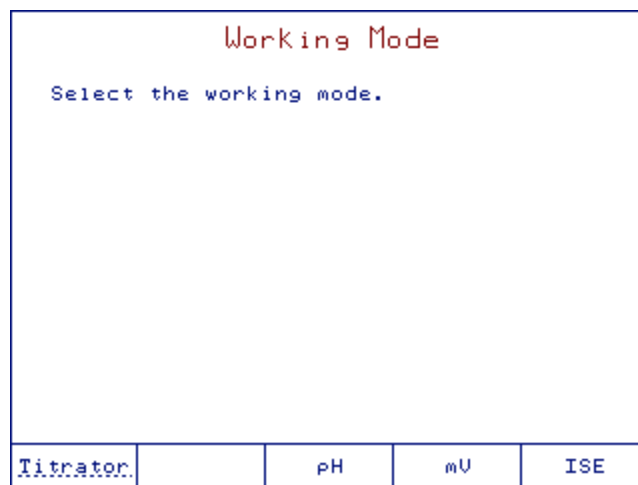

When one of these keys is pressed, the titrator will enter the selected mode:

Switches to **Titration** mode.

Switches to **pH** mode.

Switches to **mV** mode.

Switches to **ISE** mode.

6.1. DISPLAY

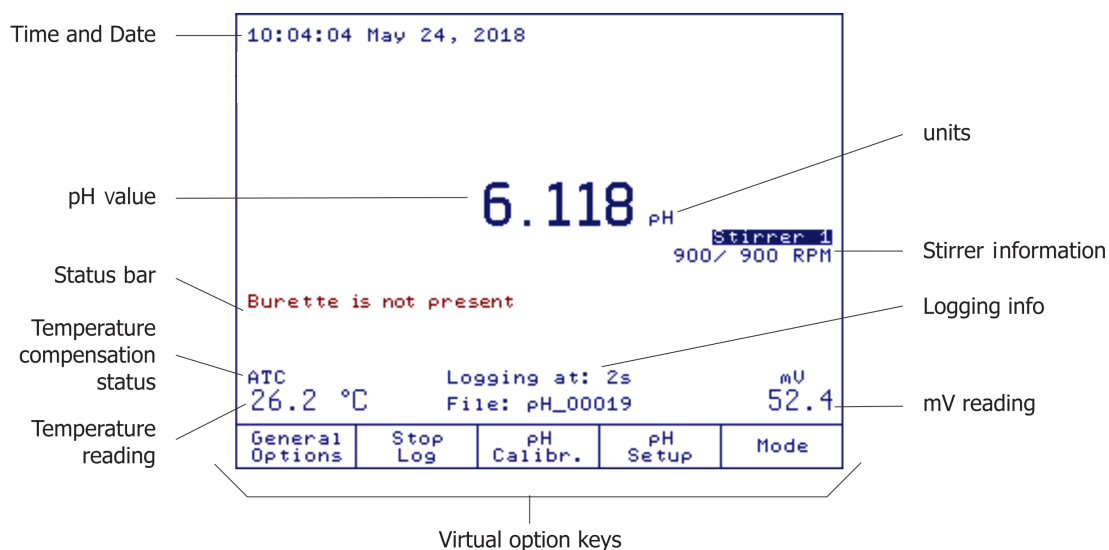

If one of these keys is pressed, the associated function is immediately performed. Some of the keys are active only in specific screens:

General Options Gives access to options that are not directly related to the measurement process. See [3. GENERAL OPTIONS](#) section for more information.

Save Reading Stores the current pH reading. See [6.4. LOGGING](#) section for more information.

OR

Start Log Starts the interval log. See [6.4. LOGGING](#) section for more information.

pH Calibr. Enters the pH calibration screen. See [6.3. pH CALIBRATION](#) section for more information.

pH Setup Enters the pH setup screen, parameters are associated with pH measurements and calibration. See [6.2. pH SETUP](#) section for more information.

Mode Allows the user to switch between the available measurement modes: **Titrat**or, **pH**, **mV** or **ISE** mode.

6.2. pH SETUP

To access pH Setup, press **pH Setup** option key while in pH mode.

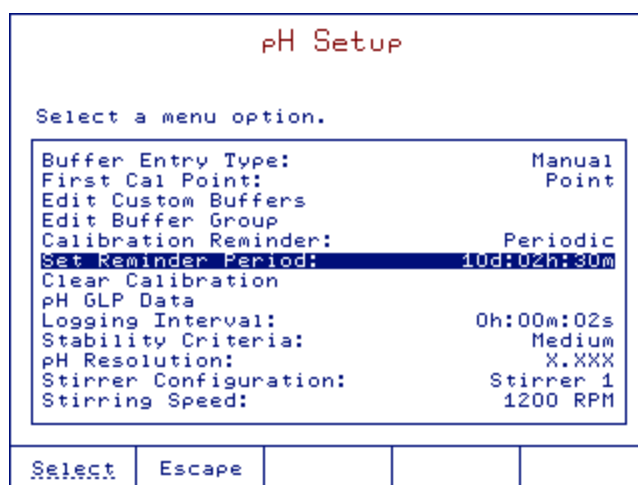

Use **▲** and **▼** keys to highlight the desired option.

Press **Select** or **enter** to access the selected option.

6.2.1. BUFFER ENTRY TYPE

Option: Automatic, Semiautomatic, Manual

The screenshot shows the 'pH Setup' menu with the following options and settings:

Buffer Entry Type:	Manual
First Cal Point:	
Edit Custom Buffers	
Edit Buffer Group	
Calibration Reminder:	
Set Reminder Period:	
Clear Calibration	
pH GLP Data	
Logging Interval:	Disabled
Stability Criteria:	Medium
pH Resolution:	X.XXX
Stirrer Configuration:	Disabled

At the bottom of the screen, there are five buttons: Select, Escape, and three empty buttons.

- Automatic** The instrument automatically selects the pH calibration point as the closest buffer from the predefined buffer group. See [6.2.4. EDIT BUFFER GROUP](#) section for more information.
- Semiautomatic** The instrument automatically selects the closest buffer from the available buffers (standard and custom buffers).
- Manual** The calibration buffer must be manually selected during calibration from the available buffer list (standard and custom buffers).

6.2.2. FIRST-CALIBRATION POINT

Option: Point or Offset

The screenshot shows the 'pH Setup' menu with the following options and settings:

Buffer Entry Type:	Manual
First Cal Point:	Point
Edit Custom Buffers	
Edit Buffer Group	
Calibration Reminder:	
Set Reminder Period:	
Clear Calibration	
pH GLP Data	
Logging Interval:	Disabled
Stability Criteria:	Medium
pH Resolution:	X.XXX
Stirrer Configuration:	Disabled

At the bottom of the screen, there are five buttons: Select, Escape, and three empty buttons.



- Point** The slope values adjacent to the calibration points will be reevaluated (normal calibration).
- Offset** The existing slope values will not be changed.

6.2.3. EDIT CUSTOM BUFFERS

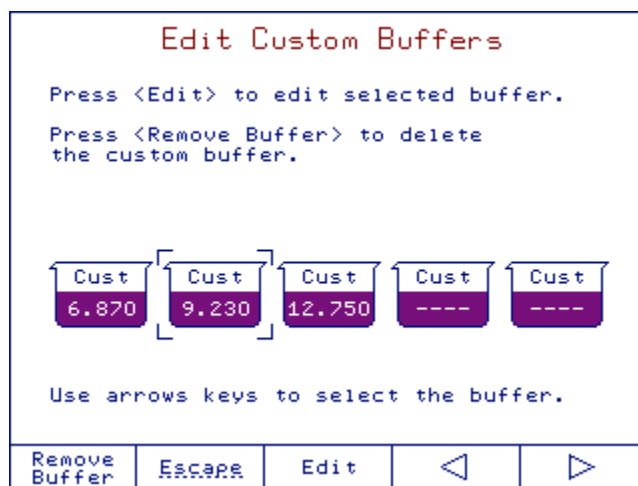

If you wish to use buffers other than the standard ones, use the Edit Custom Buffers option to set the desired pH value. Up to five pH custom buffers can be set.

Note: Custom buffers are not temperature compensated, enter the value of the buffer at the calibration temperature.

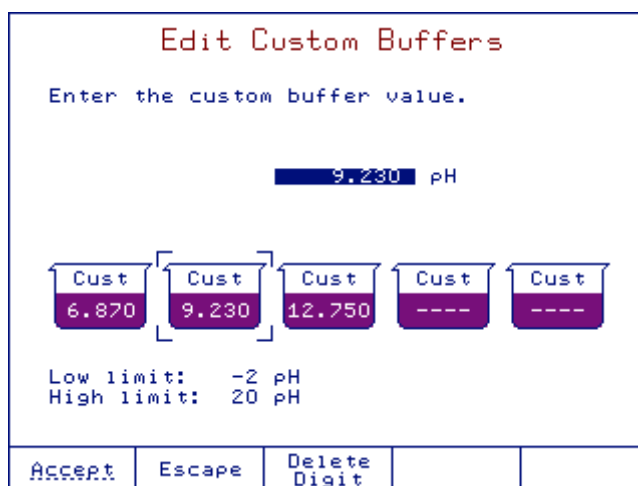

1. Use the < and > keys to select the desired buffer.
2. Press  to delete the selected buffer.
3. Press  to edit the selected buffer.



4. Use the numeric keypad to enter the pH buffer value.
5. Press  to save the value.
6. Press  to return to pH Setup menu.

6.2.4. EDIT BUFFER GROUP

Option: Up to five buffers

Select up to five buffers from the available buffers (Hanna or custom) to be used for automatic buffer recognition.

Within the buffer group, pH values must be at least 1.5 pH apart.

If the buffer group already contains five pH buffers, at least one pH buffer has to be removed in order to add another buffer.

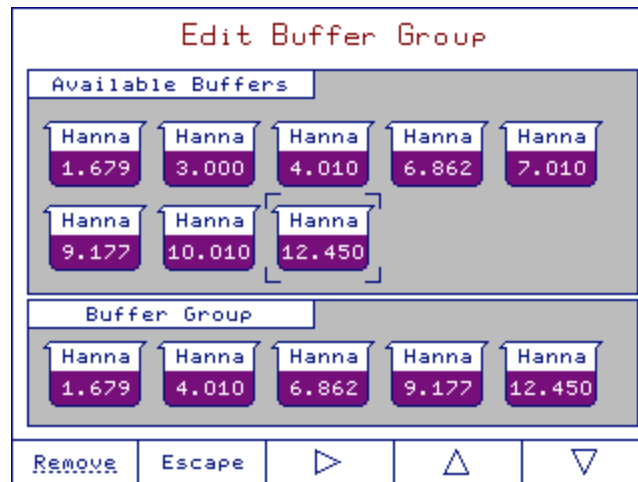

Use the arrow keys to select the pH buffer to be included / removed in / from the buffer group.

Add or **Remove** Adds or removes the selected pH buffer to / from buffer group.

Escape Returns to pH Setup menu.

6.2.5. CALIBRATION REMINDER

Option: Daily, Periodic, Disabled

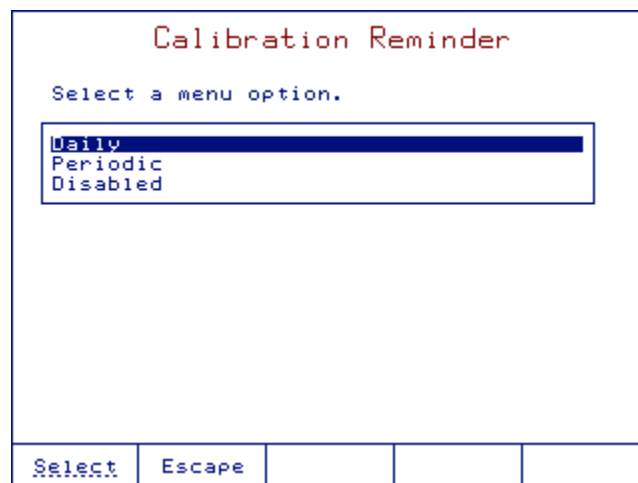

Daily The calibration reminder will appear daily at a specified time.

Periodic The calibration reminder will appear after the set time since the last calibration has elapsed.

Disabled The calibration reminder will not appear.

6.2.6. SET REMINDER PERIOD

Option: Disabled to 31 days, 23 hours and 59 minutes

If *Daily* or *Periodic* option was selected for the calibration reminder, the reminder period must also be set.

For a daily reminder period, the time of day can be set.

For a periodic reminder period, the number of days, hours and minutes can be set.

Periodic Calibration Reminder				
Enter the time period that must be passed since the last calibration, whereafter the calibration reminder appears.				
10	2	30		
days	hours	minutes		
Press Next to move to the next entry.				
Accept	Escape	Delete Digit	Next	Off

Moves the cursor to the next field.

Saves the changes or to return to the previous screen.

Disables the calibration reminder and return to pH setup.

6.2.7. CLEAR CALIBRATION

This option clears the existing pH calibration for the selected channel. If the calibration is cleared, the factory calibration will be used.

Clears the previous calibration or to return to the previous screen without clearing the calibration.

Clear Calibration				
Press <Clear> to clear all calibration points.				
Press <Escape> to return without clearing the calibration points.				
Clear	Escape			

6.2.8. pH GLP DATA

Display the pH calibration data.

pH GLP Data				
Analog 1				
Last Calibration:		10:13 May 24, 2018		
Offset: -0.1 mV		Average Slope: 100.7%		
1.679pH (Hanna)	316.2mV	26.3°C	A	
10:10:30 May 24, 2018				
4.010pH (Hanna)	177.5mV	26.3°C	A	
10:09:11 May 24, 2018				
7.010pH (Hanna)	-0.6mV	26.3°C	A	
10:08:40 May 24, 2018				
10.010pH (Hanna)	-179.1mV	26.3°C	A	
10:09:43 May 24, 2018				
12.450pH (Hanna)	-325.6mV	26.3°C	A	
10:13:15 May 24, 2018				
	Escape			

6.2.9. LOGGING INTERVAL

Option: 2 seconds to 8h 59 min 59 sec

Set the logging interval to be used- for automatic logging.

Select Off to enable manual logging.

Logging Interval				
Enter the data logging interval.				
<input type="text" value="0"/>	<input type="text" value="0"/>	<input type="text" value="2"/>		
hours	minutes	seconds		
Press Next to move to the next entry.				
Accept	Escape	Delete Digit	Next	Off

6.2.10. SIGNAL STABILITY CRITERIA

Option: Fast, Medium, Accurate

pH Setup

Select a menu option.

Buffer Entry Type:	Manual
First Cal Point:	Point
Edit Custom Buffers	
Edit Buffer Group	
Calibration Reminder:	
Set Reminder Period:	
Clear Calibration	
pH GLP Data	
Logging Interval:	
Stability Criteria:	Medium
pH Resolution:	X.XXX
Stirrer Configuration:	Disabled

Select	Escape			
--------	--------	--	--	--

Fast Quicker results, less accuracy

Medium Medium speed results, medium accuracy

Accurate Slower results, high accuracy

6.2.11. pH RESOLUTION

Option: One (X.X), Two (X.XX), Three (X.XXX) decimal places

pH Setup

Select a menu option.

Buffer Entry Type:	Manual
First Cal Point:	Point
Edit Custom Buffers	
Edit Buffer Group	
Calibration Reminder:	
Set Reminder Period:	10d:02h:30m
Clear Calibration	
pH GLP Data	
Logging Interval:	
Stability Criteria:	
pH Resolution:	X.XXX
Stirrer Configuration:	Disabled

Select	Escape			
--------	--------	--	--	--

6.2.12. STIRRER CONFIGURATION

Option: Disabled or Stirrer 1

pH Setup

Select a menu option.

Buffer Entry Type:	Manual
First Cal Point:	Point
Edit Custom Buffers	
Edit Buffer Group	
Calibration Reminder:	
Set Reminder Period:	10d:02h:30m
Clear Calibration	
pH GLP Data	
Logging Interval:	
Stability Criteria:	
pH Resolution:	
Stirrer Configuration:	Stirrer 1
Stirring Speed:	200 RPM

Select	Escape			
--------	--------	--	--	--

6.2.13. STIRRING SPEED

Option: 200 to 2500 RPM

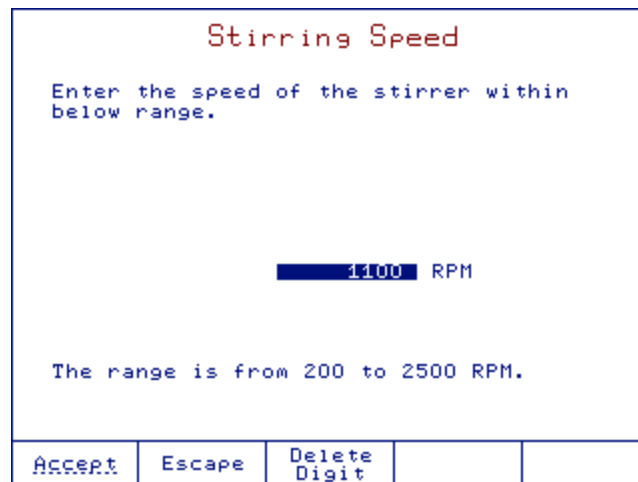

6.3. pH CALIBRATION

Calibrate the instrument often, especially if high accuracy is required.

The instrument should be recalibrated:

- Whenever the pH electrode is replaced.
- At least once a week.
- After testing aggressive chemicals.
- When “No pH Calibration” or “pH Calibration Expired” message appears on the display.

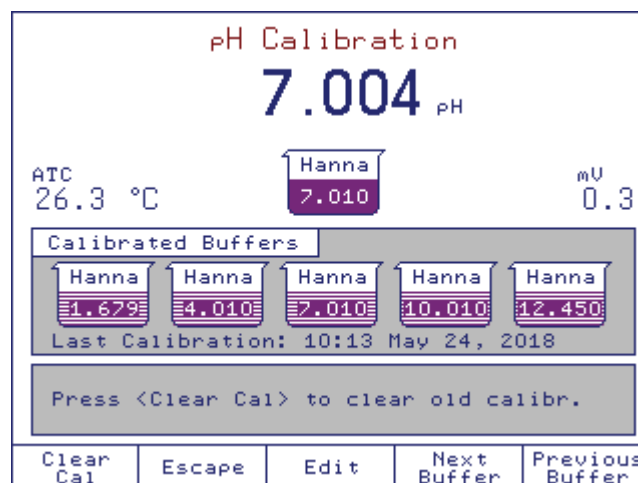

Preparation

Pour small quantities of the buffer solutions into clean beakers. If possible, use plastic beakers to minimize any EMC interferences.

For accurate calibration and to minimize cross-contamination, use two beakers for each buffer solution: one for rinsing the electrode and one for calibration. If you are measuring in the acidic range, use pH 7.01 or 6.86 as the first buffer and pH 4.01 / 3.00 or 1.68 as the second buffer. If you are measuring in the alkaline range, use pH 7.01 or 6.86 as the first buffer and pH 10.01 / 9.18 or 12.45 as the second buffer.

For extended range measurements (acidic and alkaline), perform a five-point calibration by selecting five buffers across the entire pH range.

Calibration procedure

During calibration, the user has a choice of 8 standard buffers: (pH 1.68, 3.00, 4.01, 6.86, 7.01, 9.18, 10.01, 12.45) and up to 5 custom buffers.

For accurate measurements it is recommended to perform a five-point calibration. However, at least a two-point calibration is suggested. For pH titrations, the selected buffers should bracket your endpoint (e.g. if your endpoint value is at 8.5, use 7.01 or 6.86 and 9.18 or 10.01 for calibration).

To begin calibration:

1. Press If the instrument was calibrated before, previous calibration can be cleared by pressing .

Note: It is very important to clear calibration history when a new electrode is used.

2. Immerse the pH electrode and the temperature probe approximately 4 cm (1.5") into a buffer solution and stir gently.
3. If necessary, select the pH calibration buffer value with or .
4. Once the reading has stabilized, press to update the calibration. The calibration buffer will be added to the Calibrated Buffers section.
5. Rinse the pH electrode and the temperature probe, then immerse them into the next buffer solution and follow the above procedure or press to exit the calibration.

Notes:

- The new calibration points will replace old ones if the difference between them is ± 0.2 pH.
- Buffers used in previous calibrations will not have a solid background.
- If calibrating with a standard buffer in MTC mode, the pH value and temperature can be modified by pressing . The values can be adjusted using the numeric keys. Press to save the new values.

Manual Edit				
Edit pH buffer and manual temperature.				
Buffer: <input type="text" value="7.010"/> pH				
Temperature: 25.0 °C				
Low limit: 6.990 pH				
High limit: 7.030 pH				
Press Next to move to the next entry.				
<input type="button" value="Accept"/>	<input type="button" value="Escape"/>	<input type="button" value="Delete Digit"/>	<input type="button" value="Next"/>	<input type="button" value="Edit"/>

- In ATC mode, the pH value for custom buffers can be modified by pressing .
- If the Automatic Buffer entry type was selected for the calibration procedure, the titrator will automatically select the buffer closest to the measured pH value from the buffer group.
- If the Semiautomatic Buffer entry type was selected, use the or to select the buffer. Only buffers in the buffer group will be displayed.

Calibration messages:

Wrong Buffer. Please check the buffer.

The message is displayed when the difference between the pH reading and the value of the selected calibration buffer is significant. Check if you have selected the appropriate calibration buffer.

Wrong buffer temperature.

The message is displayed if the buffer temperature is out of the defined temperature range.

Clean the electrode or check the buffer. Press to update calibration.

This message alerts the user that some dirt or deposits could be on the electrode, or the buffer is contaminated.

Slope too low. Please check the buffer .

This message appears if the current slope is under 80% of the default slope. Recalibrate the instrument using fresh buffers.

Slope too high. Press to clear the old calibration.

This message appears as a result of an erroneous slope condition.

6.4. LOGGING

Data logging is available in pH mode. It can be logging on demand (Manual Logging) or automatically (Interval Logging) at predefined time intervals.

The the logging report can be customized. See [9.3.5. SETTING UP pH / mV / ISE REPORT](#) for more information.

6.4.1. INTERVAL LOGGING

The logging interval is set in the pH Setup screen.

Press to start the log.

The logging interval and name of logging file will be displayed on the measure screen.

To stop the automatic logging, press Stop.

6.4.2. MANUAL LOGGING

To manually log pH readings, press from the pH measurement screen.

A new record will be added to the report every time is pressed.

7. mV MODE

By pressing from the main screen, the titrator can be switched to **Titrator**, **pH**, **mV** or **ISE** modes.

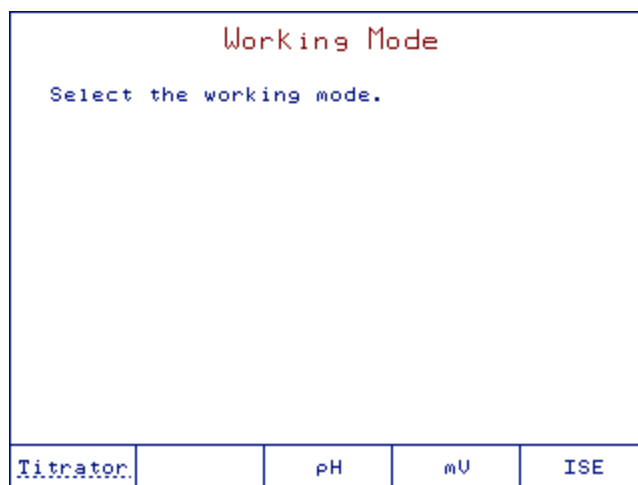

When one of these keys is pressed, the titrator will enter the selected mode:

- Switches to **Titrator** mode.
- Switches to **pH** mode.
- Switches to **mV** mode.
- Switches to **ISE** mode.

7.1. DISPLAY

The mV screen is shown below:

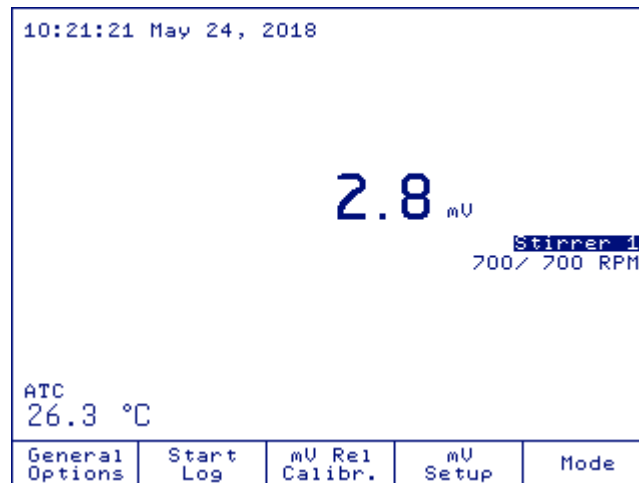

If one of these keys is pressed, the associated function is immediately performed. Some of the keys are active only in specific screens:

General Options Gives access to options that are not directly related to the measurement process. See [3. GENERAL OPTIONS](#) section for more information.

Save Reading Stores the current pH reading. See [7.4. LOGGING](#) section for more information.

OR

Start Log Starts the interval log. See [7.4. LOGGING](#) section for more information.

mV Calibr. Enters the pH calibration screen. See [7.3. RELATIVE mV CALIBRATION](#) section for more information.

pH Setup Enters the pH setup screen, parameters are associated with pH measurements and calibration. See [7.2. mV SETUP](#) section for more information.

Mode Allows the user to switch between measurement modes: **Titration**, **pH**, **mV** or **ISE** mode.

7.2. mV SETUP

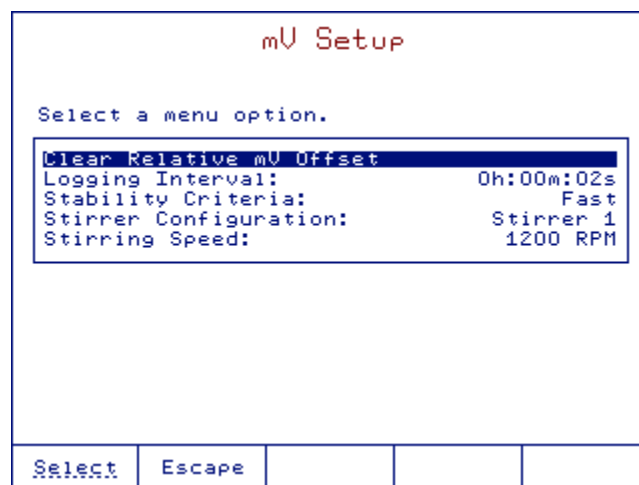

7.2.1. CLEAR RELATIVE mV OFFSET

Clear Clears the relative mV offset or **Escape** to return to the previous screen.

<p>Clear Relative mV Offset</p> <p>Press Clear to clear the relative mV offset.</p> <p>Press Escape to return without clearing the relative mV offset.</p>				
Clear	Escape			

7.2.2. LOGGING INTERVAL

Option: 2 seconds to 8h 59min 59sec

Press Off to enable manual logging.

<p>Logging Interval</p> <p>Enter the data logging interval.</p> <p style="text-align: center;"> 0 0 2 hours minutes seconds </p> <p>Press Next to move to the next entry.</p>				
Accept	Escape	Delete Digit	Next	Off

7.2.3. STABILITY CRITERIA

Option: Fast, Medium, Accurate

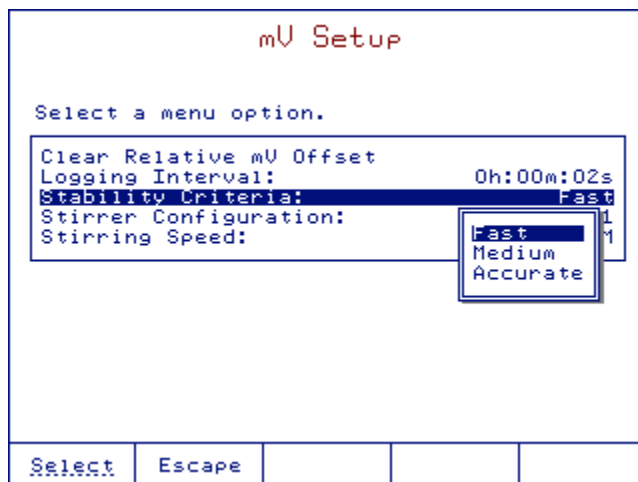

Fast Quicker results, less accuracy

Medium Medium speed results, medium accuracy

Accurate Slower results, high accuracy

7.2.4. STIRRER CONFIGURATION

Option: Stirrer 1 or Disabled

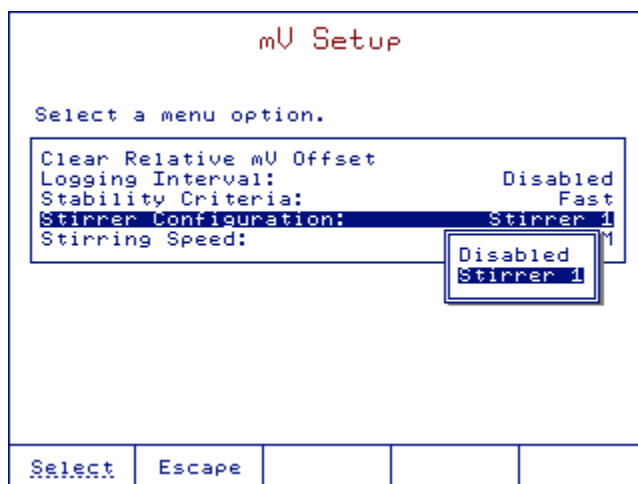

7.2.5. STIRRING SPEED

Option: 200 to 2500 RPM

<p style="color: red;">Stirring Speed</p> <p>Enter the speed of the stirrer within below range.</p> <p style="text-align: center;">1100 RPM</p> <p>The range is from 200 to 2500 RPM.</p>				
Accept	Escape	Delete Digit		

7.3. RELATIVE mV CALIBRATION

<p style="color: red;">Relative mV</p> <p>Analog 1</p> <p>Set the value for the relative mV offset.</p> <p>Absolute mV: 2.7 mV</p> <p style="text-align: right;">Stirrer 1 1100/1100 RPM</p> <p>Relative mV: 2.7 mV</p> <p>Low limit: -1997.3 mV</p> <p>High limit: 2002.7 mV</p>				
Accept	Escape	Delete Digit		

Accept Accepts the value.

Escape Cancels this operation and return to the previous screen.

Delete Digit Deletes the last digit.

7.4. LOGGING

Data logging is available in mV mode. It can be logging on demand (Manual Logging) or automatically (Interval Logging) at predefined time intervals.

The the logging report can be customized. See [9.3.5. SETTING UP pH / mV / ISE REPORT](#) section for more information.

7.4.1. INTERVAL LOGGING

The logging interval is set in the mV Setup screen.

Press Start Log to start the log.

The logging interval and name of logging file will be displayed on the measure screen.

To stop the automatic logging, press Stop.

7.4.2. MANUAL LOGGING

To manually log mV readings, press Save Reading from the mV measurement screen.



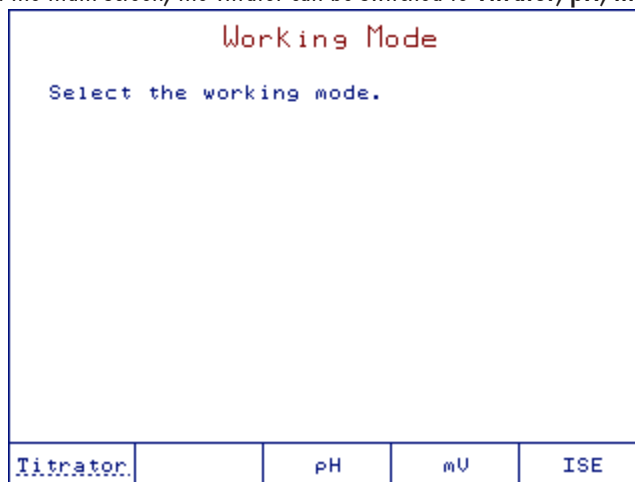

A new record will be added to the report every time Save Reading is pressed.

8. ISE MODE

By pressing  from the main screen, the Titrator can be switched to **Titration**, **pH**, **mV** or **ISE** modes.



When one of these keys is pressed, the titrator will enter the selected mode:





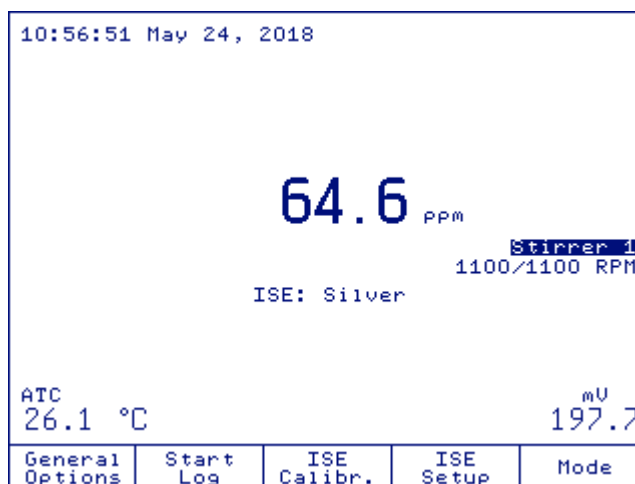

-  Switches to **Titration** mode.
-  Switches to **pH** mode.
-  Switches to **mV** mode.
-  Switches to **ISE** mode.

8.1. DISPLAY

The **ISE** screen is shown below.



If one of these keys is pressed, the associated function is immediately performed. Some of the keys are active only in specific screens:

-  Gives access to options that are not directly related to the measurement process. See [3. GENERAL OPTIONS](#) section for more information.
-  Stores the current concentration reading. See [8.4. LOGGING](#) section for more information.
- OR
-  Starts the interval log. See [8.4. LOGGING](#) section for more information.
-  Enters the ISE calibration screen. See [8.3. ISE CALIBRATION](#) section for more information.
-  Enters the ISE setup screen. Parameters are associated with ISE measurements and calibration.
-  Allows the user to switch between measurement modes: **Titration**, **pH**, **mV** and **ISE** mode.

8.2. ISE SETUP

To access the ISE Setup, press  option key in ISE mode.

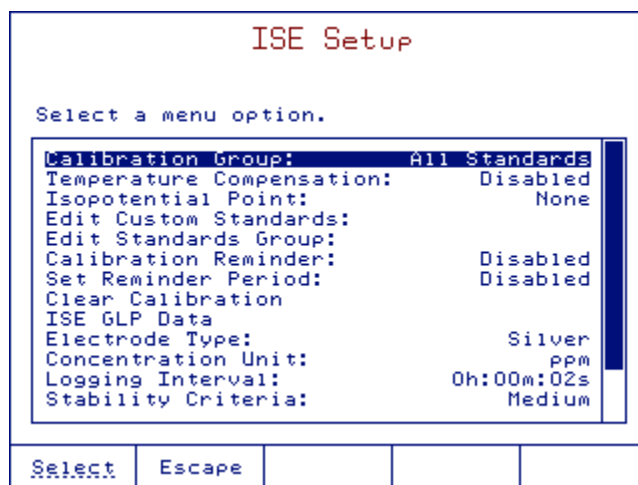

8.2.1. CALIBRATION GROUP

Option: All Standards or Standards Group

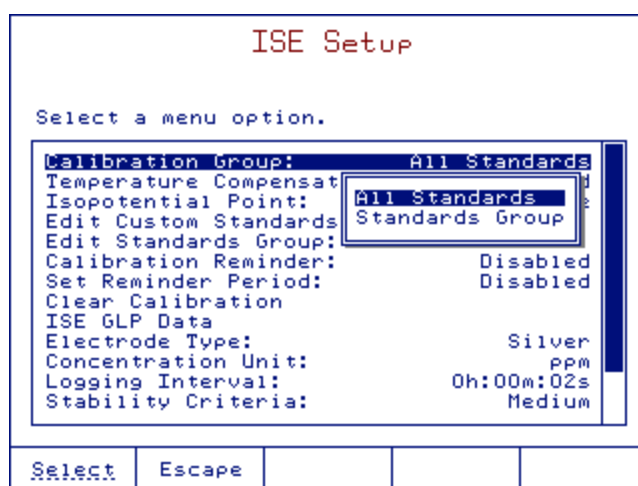

- All Standards** Includes both standard and custom solutions.
- Standards Group** Includes only the standards selected by the user.

8.2.2. TEMPERATURE COMPENSATION

Option: Enabled or Disabled

Note: When Temperature compensation is enabled, the isopotential point must also be set.

ISE Setup	
Select a menu option.	
Calibration Group:	All Standards
Temperature Compensation:	Disabled
Isopotential Point:	20.0 ppm
Edit Custom Standards:	Disabled
Edit Standards Group:	Enabled
Calibration Reminder:	Disabled
Set Reminder Period:	Disabled
Clear Calibration	
ISE GLP Data	
Electrode Type:	Silver
Concentration Unit:	ppm
Logging Interval:	0h:00m:02s
Stability Criteria:	Medium
Select	Escape

8.2.3. ISOPOTENTIAL POINT (TEMPERATURE COMPENSATION)

Option: 1.00 E^{-2} to 1.00 E^{+5} ppm

This option allows the user to set an isopotential point for the selected electrode when temperature compensation is enabled. The isopotential point is edited in ppm units only. The isopotential point will vary for different electrodes, if measurements are going to be made at several temperatures, the value should be entered if it is known.

Isopotential Point	
Enter the value for isopotential point.	
20.0 ppm	
Low limit: $1.00\text{E}-2$ ppm	
High limit: $1.00\text{E}+5$ ppm	
Accept	Escape
Delete Digit	Exponent

8.2.4. EDITING CUSTOM STANDARDS

Option: Up to five

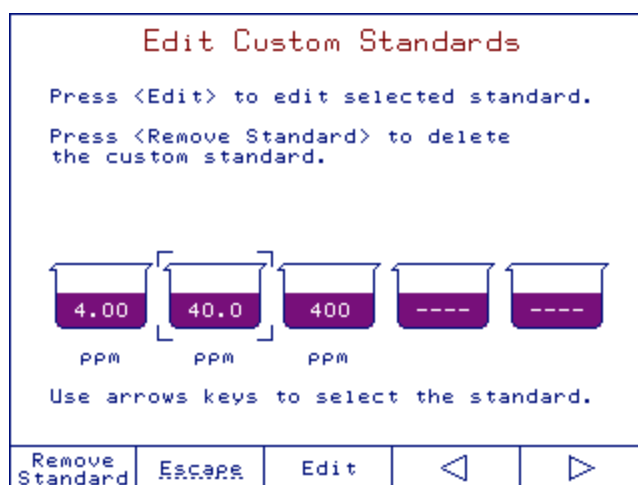

1. Use the and keys to select the standard.
2. Press to delete the standard.
3. Press to edit the selected custom standard; use the numeric keys to edit the standard.

8.2.5. EDITING STANDARD GROUP

Option: Up to 5 standards

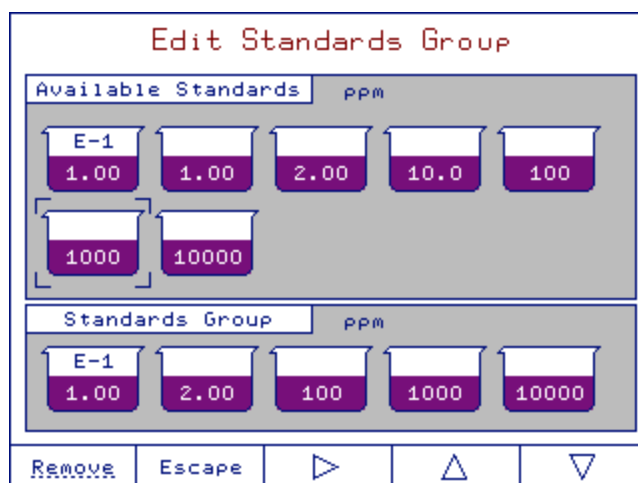

Use the arrow keys to select the standard to be included in / removed from the standard group.

or Adds or removes the selected standard to / from standard group.

Returns to ISE Setup menu.

8.2.6. CALIBRATION REMINDER

Option: Daily, Periodic, Disabled

Calibration Reminder							
Select a menu option.							
<table border="1"> <tr> <td>Daily</td> </tr> <tr> <td>Periodic</td> </tr> <tr> <td>Disabled</td> </tr> </table>					Daily	Periodic	Disabled
Daily							
Periodic							
Disabled							
Select	Escape						

Daily The calibration reminder will appear daily, at specified time.

Periodic The calibration reminder will appear after the set time since the last calibration has elapsed.

Disable The calibration reminder will not appear.

8.2.7. SETTING REMINDER

If Daily or Periodic option was selected for the calibration reminder, the reminder period must also be set.

For a daily reminder, the time of day can be set.

For a periodic reminder period the number of days, hours and minutes can be set.

Periodic Calibration Reminder				
Enter the time period that must be passed since the last calibration, whereafter the calibration reminder appears.				
10 days	2 hours	30 minutes		
Press Next to move to the next entry.				
Accept	Escape	Delete Digit	Next	Off

Next Moves the cursor to the next field.

Accept Saves the changes or **Escape** to return to the previous screen.

Off Disables the calibration reminder and return to ISE setup menu.

8.2.8. CLEARING CALIBRATION

This option clears the existing ISE calibration. If the calibration is cleared, a new calibration must be done in order to take measurements.

Clears the previous calibration or to return to the previous screen.

Clear Calibration				
Press <Clear> to clear all calibration points.				
Press <Escape> to return without clearing the calibration points.				
Clear	Escape			

8.2.9. ISE GLP DATA

Displays the ISE calibration data

ISE GLP Data				
Analog 1				
Last Calibration: 13:42 May 24, 2018				
Slope: 100.8% ISE: Silver				
Isopotential Point: 20.0 ppm				
1.00E-1 ppm, 0.1mV 28.1°C A				
13:39:43 May 24, 2018				
1.00 ppm, 59.5mV 28.1°C A				
13:40:39 May 24, 2018				
2.00 ppm, 77.6mV 28.1°C A				
13:41:25 May 24, 2018				
10.0 ppm, 120.0mV 28.1°C A				
13:41:45 May 24, 2018				
100 ppm, 181.0mV 28.2°C A				
13:42:17 May 24, 2018				
	Escape			

8.2.10. ELECTRODE TYPE

Option: Ammonia, Bromide, Cadmium, Calcium, Carbon Dioxide, Chloride, Cupric, Cyanide, Fluoride, Iodide, Lead, Nitrate, Potassium, Silver, Sodium, Sulfate, Sulfide, five custom electrodes

Electrode Type

Select a menu option.

Ammonia
Bromide
Cadmium
CaLcium
Carbon Dioxide
Chloride
Cupric
Cyanide
Fluoride
Iodide
Lead
Nitrate
Potassium
Silver

Select	Escape	View	Page Up	Page Down
--------	--------	------	---------	-----------

View See the ion constants (name, molar weight, electric charge / slope).

Escape Returns to the setup screen.

Ion Constants

View Ion constants.

Name:	Silver
Molar Weight:	107.868 g/mol
Electric Charge / Slope:	1 / 59.16

Escape			
--------	--	--	--

The Ion Constants for Custom Electrodes can be modified.

8.2.10.1. Name

Option: up to 10 characters

Electrode Name

Select the highlighted letter by using the arrow keys then press "Enter". Select the empty field for a space. Press Accept to save the entire name.

█	A	B	C	D	E	F	G	H	I	J	K	L				
	M	N	O	P	Q	R	S	T	U	V	W	X	Y			
	Z	a	b	c	d	e	f	g	h	i	j	k	l			
	m	n	o	p	q	r	s	t	u	v	w	x	y			
	z	À	Á	Â	Ã	Ä	Å	Ç	È	É	Ê	Ë	Ì	Í	Î	Ï
	Ò	Ó	Ô	Õ	Ö	Ù	Ú	Û	Ü	Ý	à	á	â	ã		
	ä	ç	è	é	ê	ë	ì	í	î	ï	ò	ó	ô	õ	ö	
	ù	ú	û	ü	¿	¡	*	\	_	\$	'	^	#	:		
	0	1	2	3	4	5	6	7	8	9	%	.	,			
	?	!	()	[]	<	>	=	/	+	-	,			

█ Custom1 █

Accept	Escape	Delete Letter	Cursor Left	Cursor Right
--------	--------	---------------	-------------	--------------

8.2.10.2. Molar Weight

Option: 0.001 g / mol to 1000.000 g / mol

Ion Molar Weight				
Set the value for Ion molar weight.				
10.000 g/mol				
Low limit: 0.001 g/mol				
High limit: 1000.000 g/mol				
Accept	Escape	Delete Digit		

8.2.10.3. Electric Charge / Slope

Option: 2 / 29.58, 1 / 59.16, -1 / -59.16, -2 / -29.58 or None / -59.16

Electric Charge / Slope									
Select the option.									
<table border="1"> <tbody> <tr> <td>2 / 29.58</td> </tr> <tr> <td>1 / 59.16</td> </tr> <tr> <td>-1 / -59.16</td> </tr> <tr> <td>-2 / -29.58</td> </tr> <tr> <td>None / -59.16</td> </tr> </tbody> </table>					2 / 29.58	1 / 59.16	-1 / -59.16	-2 / -29.58	None / -59.16
2 / 29.58									
1 / 59.16									
-1 / -59.16									
-2 / -29.58									
None / -59.16									
Select	Escape								

8.2.11. CONCENTRATION UNIT

Options: ppt (g / L), ppm (mg / L), ppb (μg / L), mg / mL, M (mol / L), mmol / L, %w / v, user defined

ISE Setup																														
Select a menu option.																														
<table border="1"> <tbody> <tr> <td>Calibration Group:</td> <td>All Standards</td> </tr> <tr> <td>Temperature Compensation:</td> <td>Disabled</td> </tr> <tr> <td>Isopotential Point:</td> <td>None</td> </tr> <tr> <td>Edit Custom Standards:</td> <td></td> </tr> <tr> <td>Edit Standards Group:</td> <td></td> </tr> <tr> <td>Calibration Reminder:</td> <td></td> </tr> <tr> <td>Set Reminder Period:</td> <td></td> </tr> <tr> <td>Clear Calibration</td> <td></td> </tr> <tr> <td>ISE GLP Data</td> <td></td> </tr> <tr> <td>Electrode Type:</td> <td></td> </tr> <tr> <td>Concentration Unit:</td> <td>ppm</td> </tr> <tr> <td>Logging Interval:</td> <td>0h:00m:02s</td> </tr> <tr> <td>Stability Criteria:</td> <td>Medium</td> </tr> </tbody> </table>					Calibration Group:	All Standards	Temperature Compensation:	Disabled	Isopotential Point:	None	Edit Custom Standards:		Edit Standards Group:		Calibration Reminder:		Set Reminder Period:		Clear Calibration		ISE GLP Data		Electrode Type:		Concentration Unit:	ppm	Logging Interval:	0h:00m:02s	Stability Criteria:	Medium
Calibration Group:	All Standards																													
Temperature Compensation:	Disabled																													
Isopotential Point:	None																													
Edit Custom Standards:																														
Edit Standards Group:																														
Calibration Reminder:																														
Set Reminder Period:																														
Clear Calibration																														
ISE GLP Data																														
Electrode Type:																														
Concentration Unit:	ppm																													
Logging Interval:	0h:00m:02s																													
Stability Criteria:	Medium																													
Select	Escape																													

8.2.12. LOGGING INTERVAL

Option: 2 seconds to 8h 59 min. 59 sec.

Logging Interval

Enter the data logging interval.

0 0 2
 hours minutes seconds

Press Next to move to the next entry.

Accept	Escape	Delete Digit	Next	Off
--------	--------	--------------	------	-----

8.2.13. STABILITY CRITERIA

Option: Fast, Medium, Accurate

ISE Setup

Select a menu option.

Calibration Group: All Standards

Temperature Compensation: Enabled

Isopotential Point: 20.0 ppm

Edit Custom Standards:

Edit Standards Group:

Calibration Reminder: Disabled

Set Reminder Period: Disabled

Clear Calibration

ISE GLP Data

Electrode Type:

Concentration Unit:

Logging Interval:

Fast
Medium
 Accurate

Stability Criteria: Medium

Select	Escape			
--------	--------	--	--	--

- Fast** Quicker results, less accuracy
- Medium** Medium speed results, medium accuracy
- Accurate** Slower results, high accuracy

8.2.14. ISE SIGNIFICANT DIGITS

Option: One (X), Two (XX), Three (XXX).

ISE Setup	
Select a menu option.	
Temperature Compensation:	Enabled
Isopotential Point:	20.0 ppm
Edit Custom Standards:	
Edit Standards Group:	
Calibration Reminder:	Disabled
Set Reminder Period:	Disabled
Clear Calibration	
ISE GLP Data	
Electrode Type:	X
Concentration Unit:	XX
Logging Interval:	0h:0
Stability Criteria:	XXX
ISE Significant Digits:	XXX
Select	Escape

8.2.15. STIRRER CONFIGURATION

Option: Disabled, Stirrer 1

ISE Setup	
Select a menu option.	
Isopotential Point:	None
Edit Custom Standards:	
Edit Standards Group:	
Calibration Reminder:	Disabled
Set Reminder Period:	Disabled
Clear Calibration	
ISE GLP Data	
Electrode Type:	Iodide
Concentration Unit:	Disabled
Logging Interval:	
Stability Criteria:	Stirrer 1
ISE Significant Digits:	
Stirrer Configuration:	Stirrer 1
Select	Escape

8.2.16. STIRRING SPEED

Option: 200 to 2500 RPM

Stirring Speed	
Enter the speed of the stirrer within below range.	
1100 RPM	
The range is from 200 to 2500 RPM.	
Accept	Escape
Delete Digit	

8.3. ISE CALIBRATION

It is recommended to calibrate the instrument frequently if high accuracy is required. The instrument should also be recalibrated whenever the “Calibrate Electrode” message appears on the LCD.

Due to electrode conditioning time, the electrode must be immersed for several seconds to stabilize. The user will be guided step by step during calibration with easy-to-follow messages on the display. This will make the calibration a simple and error-free procedure.

Preparation

Pour small quantities of the standard solution into clean beakers. If possible, use plastic beakers to minimize any EMC interferences.

For accurate calibration and to minimize cross-contamination, use two beakers for each standard solution: one for rinsing the electrode and one for calibration.

Note: For accurate measurements, add the appropriate ISA (Ionic Strength Adjustment) to the calibration standards.

Calibration procedure

Before calibrating, make sure that the electrode type and concentration unit has been selected in ISE Setup.

Up to a five-points calibration is possible using any combination of five standard solutions and five custom solutions.

The ISE calibration and measurement can be performed with or without temperature compensation. If the temperature compensation option is enabled, the isopotential point of the electrode must be set in ISE Setup.

1. Press from the main screen. If the instrument was calibrated before and the calibration was not cleared, the old calibration can be cleared by pressing .
2. Immerse the ISE and the temperature probe approximately 2 cm into the standard with the lowest concentration.
3. Select the standard concentration with or .
4. When the reading has stabilized, press to update the calibration. The calibration point value will be added to the Calibrated Standard list.
5. Select and repeat the procedure with all of the available standards.
6. Press to exit the calibration.

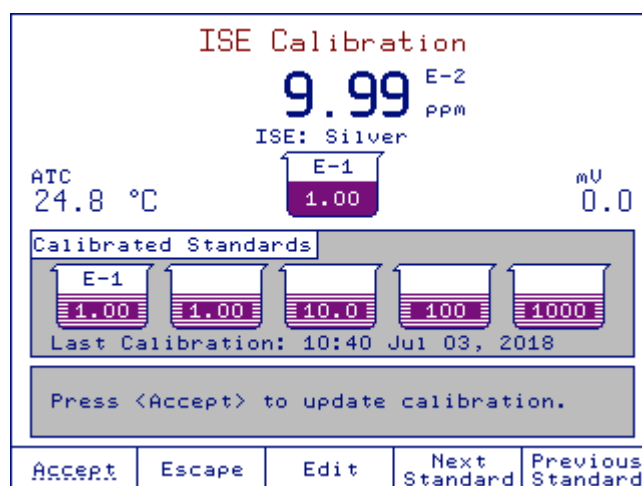

8.4. LOGGING

Data logging is available in ISE mode. It can be logging on demand (Manual Logging) or automatically (Interval Logging) at predefined time intervals.

The the logging report can be customized. See [9.3.5. SETTING UP pH / mV / ISE REPORT](#) section for more information.

8.4.1. INTERVAL LOGGING

The logging interval is set in the ISE Setup screen.

Press  to start the log.

The logging interval and name of logging file will be displayed on the measure screen.

To stop the automatic logging, press Stop.

8.4.2. MANUAL LOGGING

To manually log pH readings, press  from the ISE measurement screen.

A new record will be added to the report every time  is pressed.

9. AUXILIARY FUNCTIONS

9.1. BURETTE

To access the **Burette** screen, press **Burette** from the main titration screen.

Highlight the desired option and then press **Select**.

Burette				
Select a menu option.				
<div style="border: 1px solid black; padding: 2px;"> Prime Burette Rinse Tip Manual Dispense Purge Burette </div>				
The current pump is: Pump 1 Current burette volume is 5 mL.				
Select	Escape	Choose Pump		

Choose Pump Allows you to select the desired pump for burette operations (it is only active if two pumps are connected).

Pump Setting				
Select the current pump.				
<div style="border: 1px solid black; padding: 2px;"> Pump 1 Pump 2 </div>				
Select	Escape			

9.1.1. PRIMING THE BURETTE

Option: Up to 5

The *Prime Burette* option is used to fill the burette with titrant before starting a titration. The priming process consists of several cycles of filling and emptying the burette with titrant.

Two rinse cycles are shown in the figure below. The dispensing tube is connected on the right side and the aspiration tube on the left side.

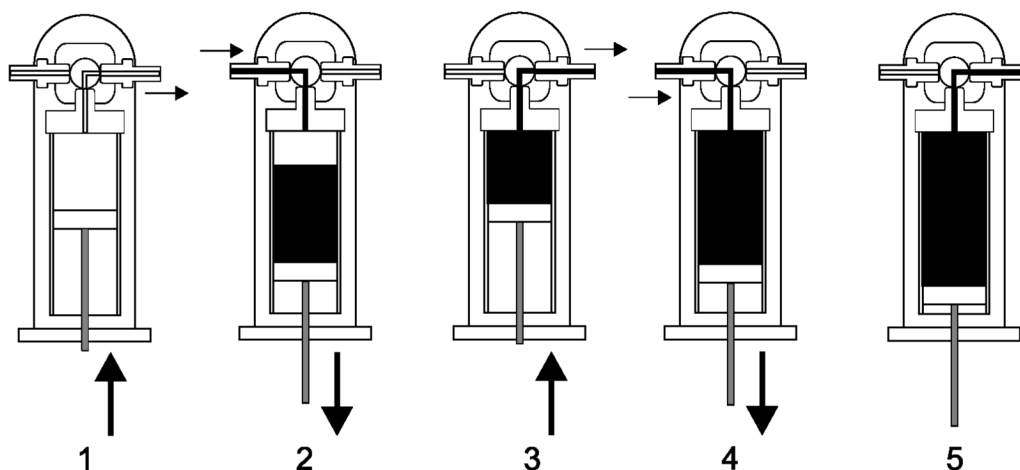

Note: Before starting this operation, the aspiration tube must be inserted in the titrant bottle. A waste container should be placed under the dispensing tip to collect the waste solution.

To prime the burette, select Prime Burette, enter the number of rinses and press .

We recommend at least three rinses to assure that the air bubbles are completely removed.

Total Burette Rinses				
Enter the total number of burette rinses.				
<div style="border: 1px solid black; display: inline-block; padding: 2px 10px;">3</div>				
A minimum of three rinses is recommended.				
Accept	Escape	Delete Digit		

9.1.2. RINSING BURETTE TIP

A 2 mL dose of titrant will be dispensed from the burette when this operation is selected, this will eliminate any air in the dispensing tip.

9.1.3. MANUAL DISPENSE

Manual Dispense option allows a defined titrant volume to be dosed. Select the *Manual Dispense* option and press

Select

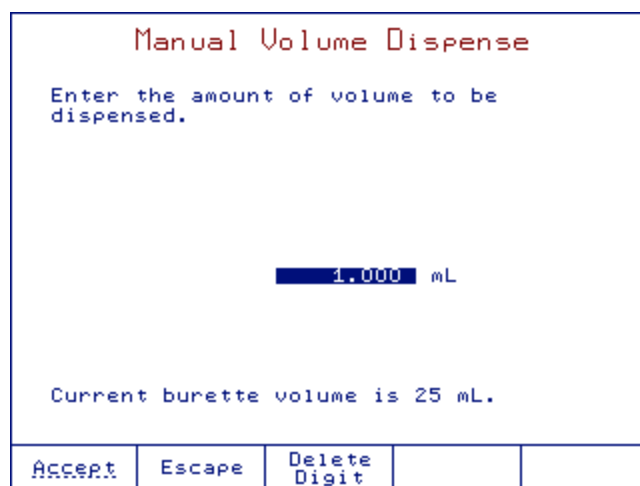

Use the numeric keypad to enter the volume to be dispensed.

The manual dispense volume must be between the limits shown below:

5 mL burette 0.001 to 4.750 mL

10 mL burette 0.001 to 9.500 mL

25 mL burette 0.005 to 23.750 mL

50 mL burette 0.005 to 47.500 mL

9.1.4. PURGING THE BURETTE

This option allows the burette to be emptied before cleaning or storing the burette. The burette is flushed twice.

Note: Before starting this operation, remove the aspiration tube from the titrant bottle.

The figures below show the steps in a purge burette operation.

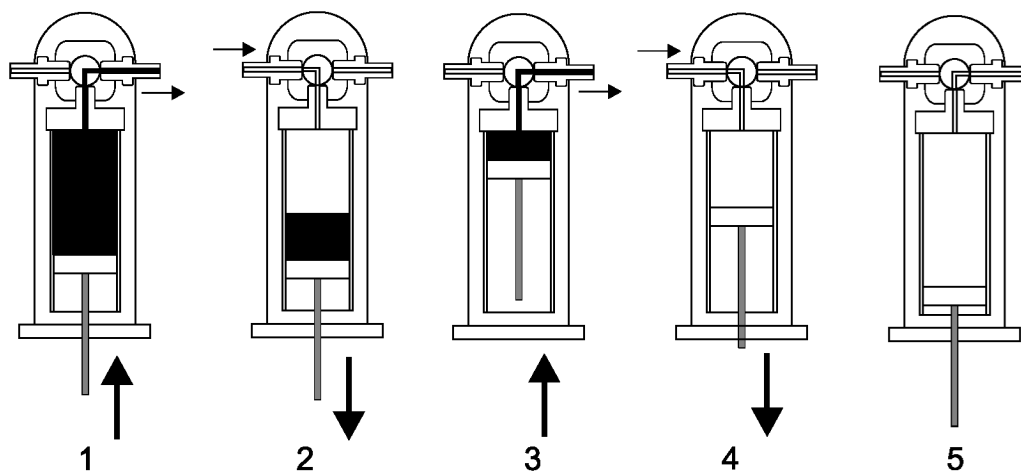

9.2. STIRRER

The stirrer can be turned on and off by pressing .

During the titration process, the stirring speed can be manually adjusted using the  and  keys.

9.3. RESULTS



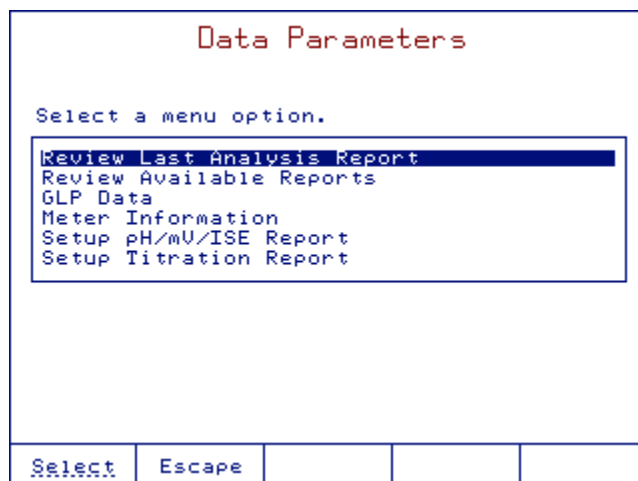

From the **Data Parameters** screen, you can access the following options:

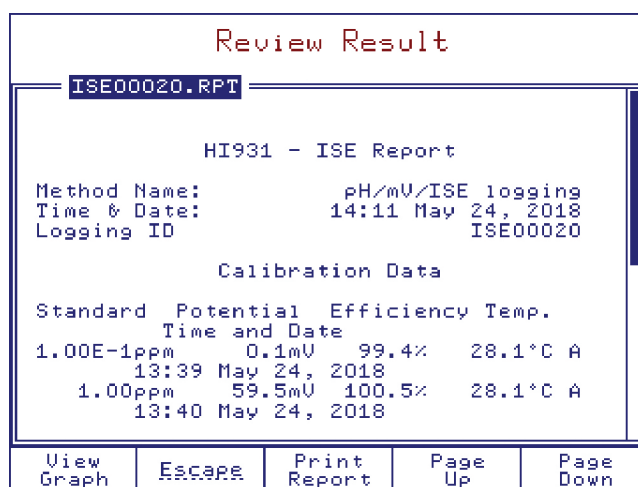

9.3.1. REVIEWING LAST ANALYSIS REPORT



The report contains information based on the selections made in the **Setup Titration Report** and **Setup ISE / pH / mV Report** screen.



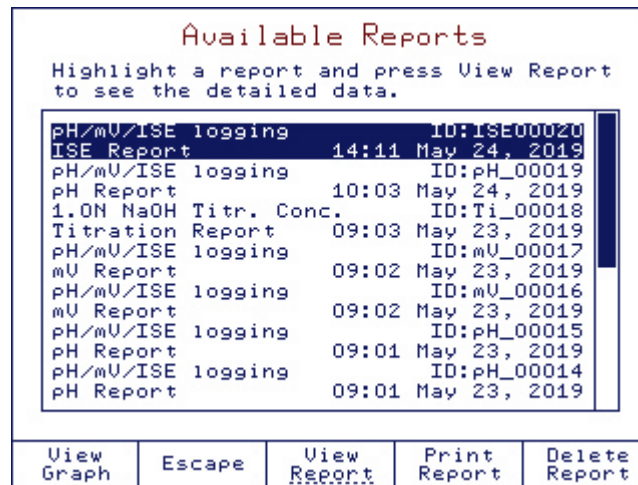

-  Review the graph.
-  Print the titration report.
-  Return to the previous screen.
-   Scroll through the pages.

9.3.2. REVIEWING AVAILABLE REPORTS

Up to 100 reports can be saved on the titrator. To view one of the saved reports, highlight a report and then press .



The report contains only the information selected in the **Setup Titration Report** and **Setup pH / mV / ISE Report** screens during report configuration.

-  Review the selected graph.
-  Review the selected report.
-  Print the selected report.
-  Delete the selected report.
-  Return to the previous screen.

9.3.3. GLP DATA

Option: Up to 20 characters

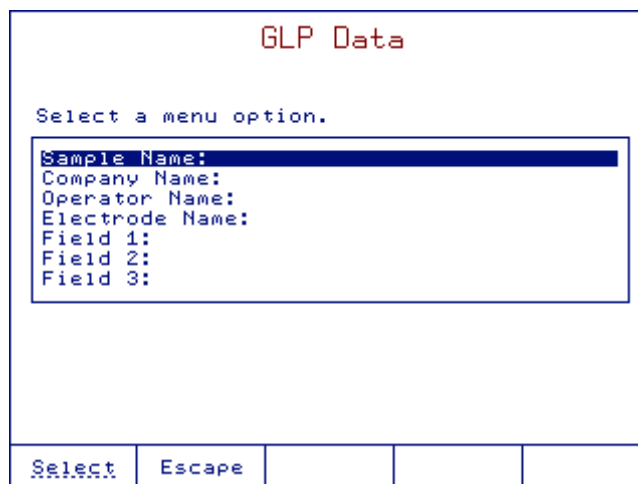

- Sample Name** Allows the sample name to be recorded in each report. The sample name will increase by one, with each new titration or logging report, if the last character is a number.
- Company Name** Allows the company name to be recorded in each report.
- Operator Name** Allows the operator name to be recorded in each report.
- Electrode Name** Allows the electrode name to be recorded in each report.
- Fields 1, 2, 3** Allows any additional information to be recorded in each report.

The fields must be selected from **Setup Titration Report** screen in order to be displayed in the titration report. See **9.3.6. SETTING UP TITRATION REPORT** section for more information.

9.3.4. METER INFORMATION

Displays titrator configuration data.

```

Meter Information
SERIAL NUMBER 931 Titrator
Titrator Serial Number:      12133404404
Analog Board1 Serial Number: 30134202202
Pump 1 Serial Number:        70094513513
Stirrer 1 Serial Number:     70091703703

SOFTWARE VERSION
Titrator Software Version:    v1.00
Base Board Software Version:  v1.00
Pump 1 Software Version:      v1.00
Stirrer 1 Software Version:   v1.00
Analog 1 Calibration Date:    May 22, 2018
  
```

Escape	Print		
--------	-------	--	--

Titrator Serial Number	The serial number of the titrator base board.
Analog Board 1 Serial Number	The serial number of the analog board.
Pump 1 (or 2) Serial Number	The serial number of the connected pump.
Titrator Software Version	The current software version installed on the titrator.
Base Board Software Version	The current software version present on the base board of the titrator.
Pump 1 (or 2) Software Version	The current software version for the pump.
Analog 1 Calibration Date	Manufacturer calibration date of the analog board.

Note: If more than 1 year elapsed from the calibration date of the analog board 1, the message “Analog 1 Calibration Due” will appear on the main screen. The analog board need to be recalibrated.

9.3.5. SETTING UP pH / mV / ISE REPORT

Customize a unique report to record the pH, mV, and ISE measurements. An asterisk means that it will be included in the report.

- Select Adds the highlighted information to the report.
- Unselect Removes the highlighted information from the report.
- Escape Returns to the Data Parameter Screen. Report is not updated.
- Save Report Updates the report with the selected items. Report previously saved will not be updated.
- Page Up Page Down Scrolls through the options.

9.3.6. SETTING UP TITRATION REPORT

Customize a unique report to record the titration results. An asterisk means that it will be included in the titration report.

- Select Adds the highlighted information to the report.
- Unselect Removes the highlighted information from the report.
- Escape Returns to the Data Parameter Screen. Report is not updated.
- Save Report Updates the report with the selected items. Report previously saved will not be updated.
- Page Up Page Down Scrolls through the options.

10. MAINTENANCE & PERIPHERALS

The 25-mL burette included with the titrator exceeds the ISO 8655 standard for accurate delivery of liquids by a motor-driven piston burette.

10.1. BURETTE MAINTENANCE

10.1.1. BURETTE ASSEMBLY

The burette is delivered with a 25-mL syringe inside and with all of the accessories mounted. See **1. SETUP** section for more information. The burette assembly consists of a rigid housing which holds the glass syringe, a 3-way valve and titrant tubing.

10.1.2. CHANGING THE BURETTE

Remove the burette from the pump assembly by sliding it forward and then slide the new burette into place.

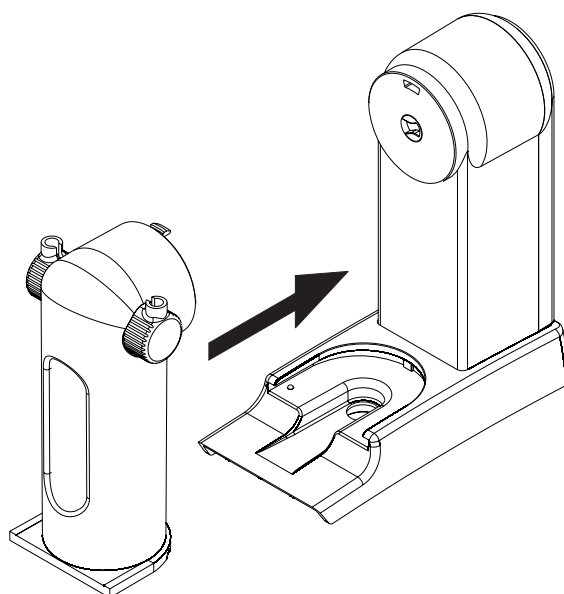

10.1.3. DISASSEMBLING THE BURETTE

The aspiration and the dispensing tubes have fittings and tube protectors. The aspiration tube is mounted on the left side and the dispensing tube is mounted on the right side of the burette.

To remove the dispensing tube and the aspiration tube follow these steps:

1. Remove the blue tube protector (A) by sliding it off the clear titrant tubing.
2. Remove the tube lock (B) from the burette holder.
3. Turn the fitting (C) counterclockwise to remove it from the burette holder.
4. Slide the clear titrant tubing through the fitting.

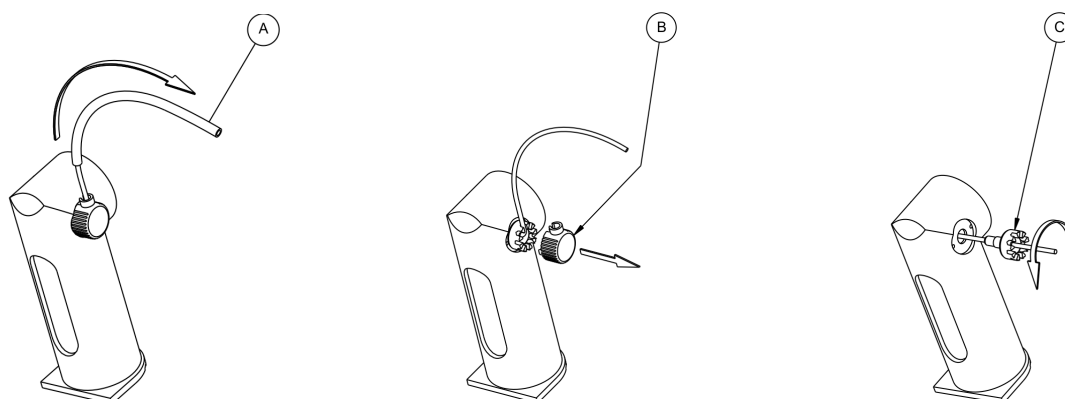

10.1.4. ASSEMBLING THE BURETTE

To attach the dispensing tube and the aspiration tube, follow these steps:

1. Insert the flat-shaped end of the titrant tubing into the valve outlet (A) and screw the fitting clockwise to tighten. The highest of the 9 cuts should be vertical in the final position.
2. Bend the tube up into the vertical position to enter the highest cut of the fitting (C).
3. Replace the tube lock fitting (D).
4. Replace the blue tube protector (E) by sliding it over the clear titrant tubing, the protector will sit in the tube lock fitting.

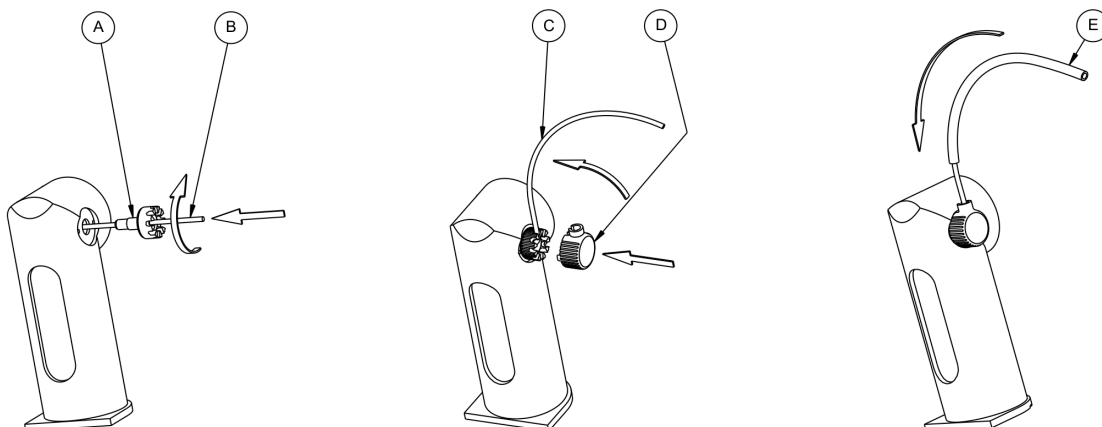

10.1.5. CLEANING THE BURETTE

To clean the burette, follow these steps:

1. If the burette is filled with titrant, remove the aspiration tube from the titrant bottle and purge burette. See [9.1.4. PURGING THE BURETTE](#) section for more information.
2. Insert the aspiration tube into cleaning solution, deionized water or titrant solvent.
3. Go through two cycles of filling and emptying the burette. See [9.1.4. PURGING THE BURETTE](#) section for more information.
4. During second cycle, remove the aspiration tube from the cleaning solution, deionized water or solvent and allow the air to replace the liquid in the burette. This will clean the aspiration tube.

If this simple cleaning procedure is not adequate, continue with these steps:

1. Remove the burette assembly from the pump.
2. Remove the dispensing and aspiration tubes. Clean them separately or insert new ones.
3. Remove the protective cap from the bottom of the burette assembly by using the burette removal tool.
4. Remove the syringe from the burette assembly by unscrewing it with your fingers.
5. Extract the piston from the syringe.
6. Clean both the piston and the syringe with appropriate cleaning solution. Rinse with deionized water.
7. Remove the excess liquid.

Warning: Avoid contacting the titrant with bare hands. Avoid spilling titrant. Clean the external side of the syringe and piston to remove aggressive chemicals. Do not touch the white PTFE part of the piston or internal walls of the burette with bare hands or greasy materials.

8. Reinsert the piston into the syringe.
9. Reinsert the syringe by screwing it in the valve with your fingers.
10. Reinsert the protective cap to the bottom of the burette assembly. Carefully position the cap into the burette.
11. Slide the burette into the burette stand. Notice the position of the piston shaft to the pump couple.
12. Priming the burette three times with new titrant is recommended.

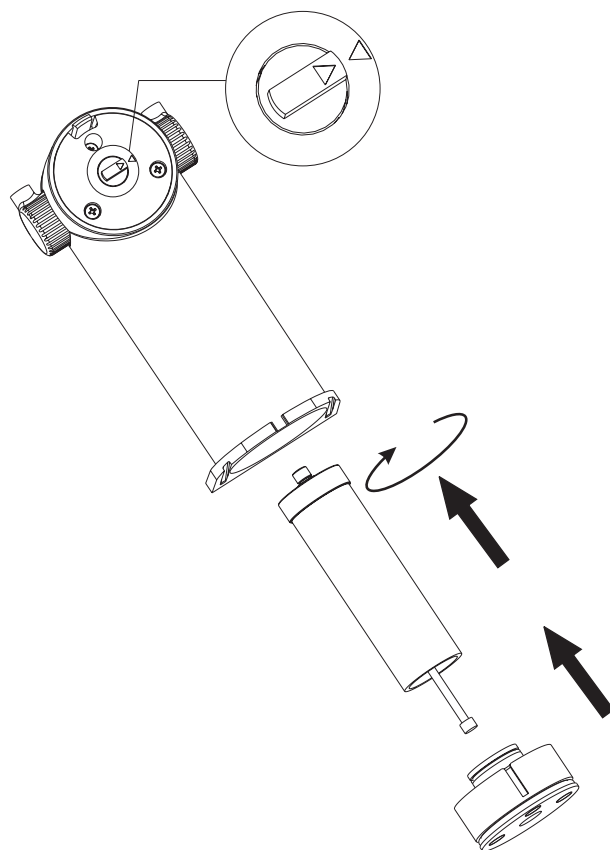

10.1.6. BURETTE PREPARATION (TITRANT FILLING)

Before starting a titration, the burette must be properly filled with titrant in order to obtain an accurate and repeatable result. To fill the burette, follow the next steps and recommendations:

1. If necessary, clean the burette and make sure it is empty.
2. From the main screen press .
3. Highlight *Prime Burette* option and press .
4. Enter the number of times the burette needs to be rinsed (minimum three rinses are recommend allowing air bubbles to be evacuated).
5. Press .

To avoid the presence of the air bubbles inside the burette, make sure to have a continuous liquid flow inside the burette. A little air just above the liquid level at the first filling is normal. The next filling will evacuate all of the air; no air will be left in the valve.

Sometimes during this process, slight finger tapping on the tubes helps remove any residual air bubbles.

If air bubbles are still present:

1. Remove the aspiration tube from the titrant bottle.
2. Repeat burette preparation procedure.
3. If this is not successful, clean the burette again.

10.2. PERIPHERALS

Warning! Connection or disconnection of POWER, PUMP ASSEMBLY, PRINTER or RS232 INTERFACE must only be done when titrator and external devices are turned off.

10.2.1. CONNECTING TO A PRINTER

A variety of parallel printers can be connected to the parallel port of the titrator using a DB25 cable.

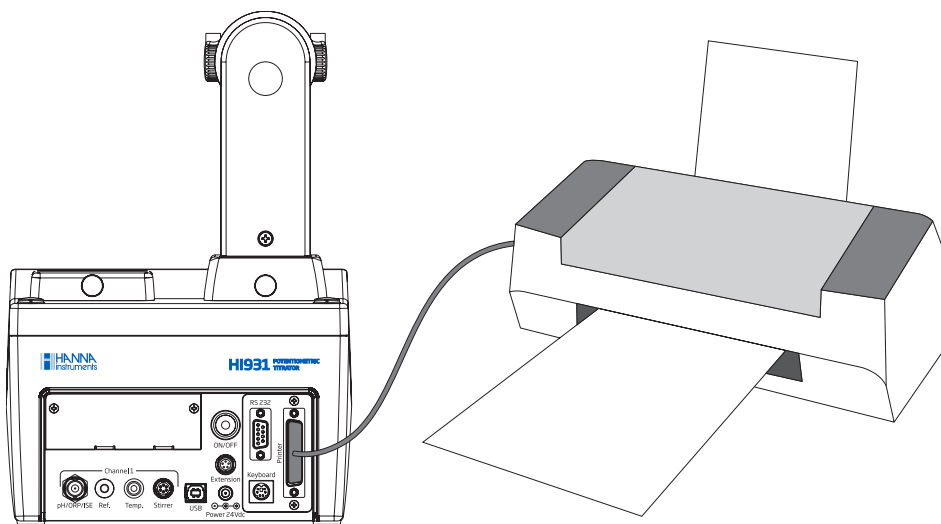







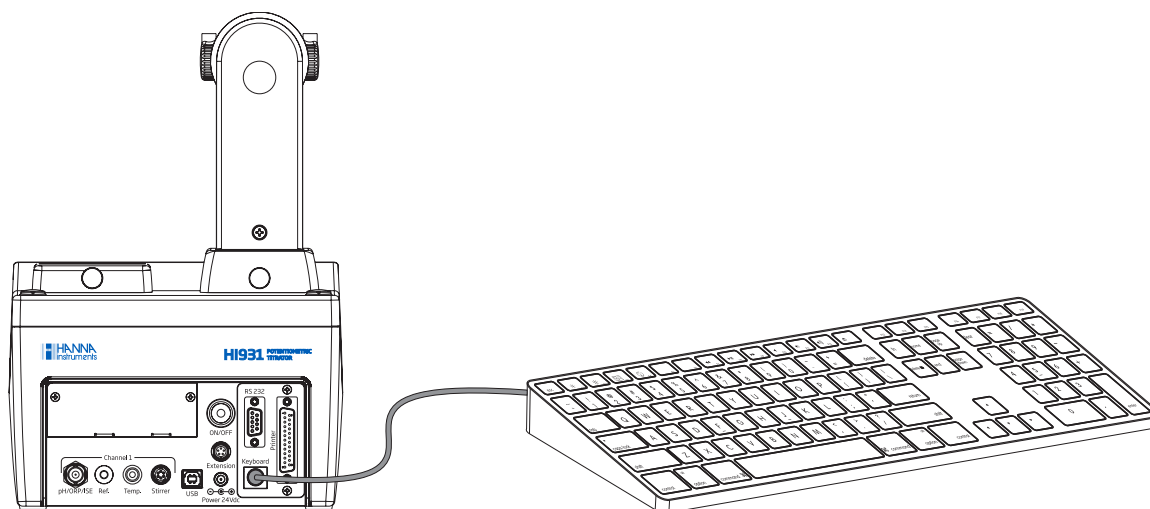





Warning: The titrator and the external printer must be both turned off before they are connected.

10.2.2. CONNECTING AN EXTERNAL PC KEYBOARD

This connection allows the use of an external PS/2 PC Keyboard in addition to the titrator's keypad.



The correspondence between the titrator's keypad and the United States 101-type external keyboard is detailed below:

External PC Keyboard (United States 101)	Titrator Keypad
Function key F-1	
Function key F-2	
Function key F-3	
Function key F-4	
Function key F-5	Option key 1 (from left to right)
Function key F-6	Option key 2 (from left to right)
Function key F-7	Option key 3 (from left to right)
Function key F-8	Option key 4 (from left to right)
Function key F-9	Option key 5 (from left to right)
Function key F-10	
Arrow key: Up	
Arrow key: Down	
Arrow key: Left	
Arrow key: Right	
Page Up	
Page Down	
Numeric keys: 0 to 9	
Enter	
Alphanumeric keys	Allow alphanumeric entries

10.2.3. CONNECTING TO A COMPUTER

The titrator can be connected to a computer using a USB cable. **HI900** PC application needs to be installed on the PC.

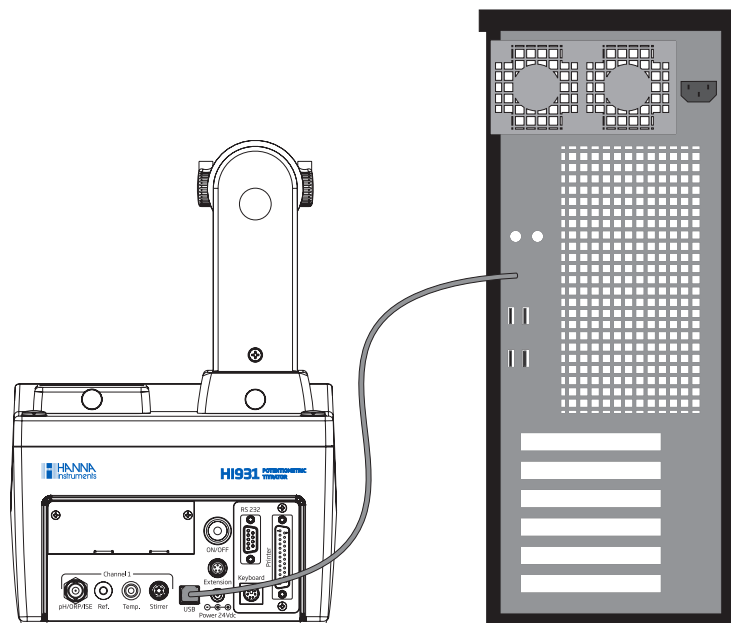

To connect the PC to the titrator follow the steps below:

1. Connect the cable to the USB port on the rear panel of the titrator.
2. Connect the cable to the USB port on the PC.

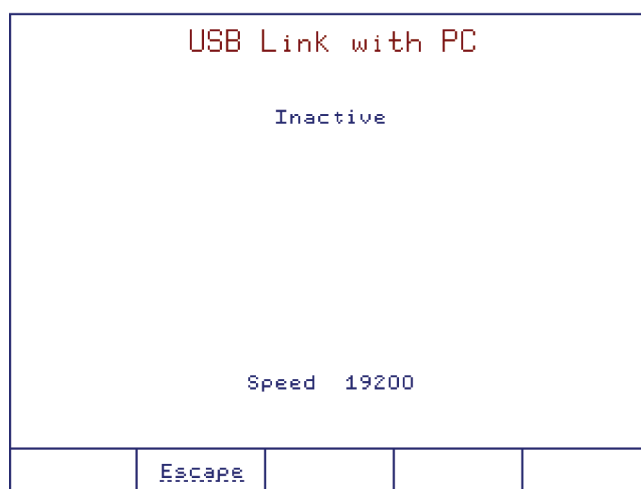

The **HI900** PC application allows the transfer of methods and reports between the titrator and PC. See **3.12. USB LINK WITH PC** section for more information.

11. ACCESSORIES

11.1. SOLUTIONS

11.1.1. pH CALIBRATION BUFFERS

HI7001M	pH 1.68 buffer solution, 230 mL
HI7001L	pH 1.68 buffer solution, 500 mL
HI7004M	pH 4.01 buffer solution, 230 mL
HI7004L	pH 4.01 buffer solution, 500 mL
HI7006M	pH 6.86 buffer solution, 230 mL
HI7006L	pH 6.86 buffer solution, 500 mL
HI7007M	pH 7.01 buffer solution, 230 mL
HI7007L	pH 7.01 buffer solution, 500 mL
HI7009M	pH 9.18 buffer solution, 230 mL
HI7009L	pH 9.18 buffer solution, 500 mL
HI7010M	pH 10.01 buffer solution, 230 mL
HI7010L	pH 10.01 buffer solution, 500 mL

11.1.2. pH CALIBRATION BUFFERS IN FDA APPROVED BOTTLE

HI8004L	pH 4.01 buffer solution, 500 mL
HI8006L	pH 6.86 buffer solution, 500 mL
HI8007L	pH 7.01 buffer solution, 500 mL
HI8009L	pH 9.18 buffer solution, 500 mL
HI8010L	pH 10.01 buffer solution, 500 mL

11.1.3. pH TECHNICAL CALIBRATION BUFFERS

HI5016	pH 1.68 buffer solution, 500 mL
HI5003	pH 3.00 buffer solution, 500 mL
HI5004	pH 4.01 buffer solution, 500 mL
HI5068	pH 6.86 buffer solution, 500 mL
HI5007	pH 7.01 buffer solution, 500 mL
HI5091	pH 9.18 buffer solution, 500 mL
HI5010	pH 10.01 buffer solution, 500 mL
HI5124	pH 12.45 buffer solution, 500 mL

11.1.4. pH MILLESIMAL CALIBRATION BUFFERS

HI6016	pH 1.679 buffer solution, 500 mL
HI6016-01	pH 1.679 buffer solution, 1 L
HI6003	pH 3.000 buffer solution, 500 mL
HI6003-01	pH 3.000 buffer solution, 1 L
HI6004	pH 4.010 buffer solution, 500 mL
HI6004-01	pH 4.010 buffer solution, 1 L
HI6068	pH 6.862 buffer solution, 500 mL
HI6068-01	pH 6.862 buffer solution, 1 L
HI6007	pH 7.010 buffer solution, 500 mL

HI6007-01	pH 7.010 buffer solution, 1 L
HI6091	pH 9.177 buffer solution, 500 mL
HI6091-01	pH 9.177 buffer solution, 1 L
HI6010	pH 10.010 buffer solution, 500 mL
HI6010-01	pH 10.010 buffer solution, 1 L
HI6124	pH 12.450 buffer solution, 500 mL
HI6124-01	pH 12.450 buffer solution, 1 L

11.1.5. ELECTRODE CLEANING SOLUTIONS

HI7061M	General purpose cleaning solution, 230 mL
HI7061L	General purpose cleaning solution, 500 mL
HI7073M	Protein cleaning solution, 230 mL
HI7073L	Protein cleaning solution, 500 mL
HI7074M	Inorganic cleaning solution, 230 mL
HI7074L	Inorganic cleaning solution, 500 mL
HI7077M	Oil & fat cleaning solution, 230 mL
HI7077L	Oil & fat cleaning solution, 500 mL

11.1.6. ELECTRODE CLEANING SOLUTIONS IN FDA APPROVED BOTTLE

HI8061M	General purpose solution, 230 mL
HI8061L	General purpose solution, 500 mL
HI8073M	Protein cleaning solution, 230 mL
HI8073L	Protein cleaning solution, 500 mL
HI8077M	Oil & fat cleaning solution, 230 mL
HI8077L	Oil & fat cleaning solution, 500 mL

11.1.7. ELECTRODE STORAGE SOLUTIONS

HI70300M	Storage solution, 230 mL
HI70300L	Storage solution, 500 mL

11.1.8. ELECTRODE STORAGE SOLUTIONS IN FDA APPROVED BOTTLE

HI80300M	Storage solution, 230 mL
HI80300L	Storage solution, 500 mL

11.1.9. ELECTRODE REFILL ELECTROLYTE SOLUTIONS

HI7071	3.5 M KCl with AgCl Reference Electrolyte Solution, 30 mL
HI7072	1 M Potassium Nitrate Electrode Fill Solution
HI7075	1.7 M Potassium Nitrate, 0.7 M Potassium Chloride Electrode Fill Solution
HI7076	1 M Sodium Chloride Electrode Fill Solution
HI7078	0.5 M Ammonium Sulfate Electrode Fill Solution
HI7082	3.5 M KCl Reference Electrolyte Solution, 30 mL

11.1.10. ELECTRODE REFILL ELECTROLYTE SOLUTIONS IN FDA APPROVED BOTTLE

HI8071	3.5 M KCl with AgCl Reference Electrolyte Solution, 30 mL
HI8072	1 M Potassium Nitrate Electrode Fill Solution
HI8082	3.5 M KCl Reference Electrolyte Solution, 30 mL

11.1.11. ORP PRETREATMENT SOLUTIONS

HI7091M	Reducing pretreatment solution, 230 mL
HI7091L	Reducing pretreatment solution, 500 mL
HI7092M	Oxidizing pretreatment solution, 230 mL
HI7092L	Oxidizing pretreatment solution, 500 mL

11.1.12. TITRATION REAGENTS

HI70429	0.05 M Silver nitrate titration reagent, 1 L
HI70433	0.01 N Stabilized iodine titration reagent, 1 L
HI70439	0.1 M Sodium thiosulfate titration reagent, 1 L
HI70440	0.02 N Stabilized iodine titration reagent, 1 L
HI70441	0.04 N Stabilized iodine titration reagent, 1 L
HI70448	0.02 M Silver nitrate titration reagent, 1 L
HI70449	0.02 M EDTA titration reagent, 1 L
HI70455	0.01 N Sodium hydroxide titration reagent, 1 L
HI70456	0.1 N Sodium hydroxide titration reagent, 1 L
HI70457	1 N Sodium hydroxide titration reagent, 1 L
HI70458	0.01 M Sulfuric acid titration reagent, 1 L
HI70459	0.05 M Sulfuric acid titration reagent, 1 L
HI70462	0.01 N Hydrochloric acid titration reagent, 1 L
HI70463	0.1 N Hydrochloric acid titration reagent, 1 L
HI70464	1 N Hydrochloric acid titration reagent, 1 L

11.1.13. ION-SELECTIVE ELECTRODE CALIBRATION STANDARDS

HI4001-01	0.1 M Ammonia standard
HI4001-02	100 ppm Ammonia standard (as N)
HI4001-03	1000 ppm Ammonia standard (as N)
HI4002-01	0.1 M Bromide standard
HI4003-01	0.1 M Cadmium standard
HI4004-01	0.1 M Calcium standard
HI4005-01	0.1 M Carbon dioxide standard
HI4005-03	1000 ppm Carbon dioxide standard (as CaCO ₃)
HI4007-01	0.1 M Chloride standard
HI4007-02	100 ppm Chloride standard
HI4007-03	1000 ppm Chloride standard
HI4008-01	0.1 M Cupric standard
HI4010-01	0.1 M Fluoride standard
HI4010-02	100 ppm Fluoride standard
HI4010-03	1000 ppm Fluoride standard
HI4011-01	0.1 M Iodide standard
HI4012-01	0.1 M Lead standard
HI4012-21	0.1 M Sulfate standard
HI4013-01	0.1 M Nitrate standard

HI4013-02	100 ppm Nitrate standard
HI4013-03	1000 ppm Nitrate standard
HI4014-01	0.1 M Potassium standard
HI4015-01	0.1 M Silver standard

11.2. SENSORS

11.2.1. pH ELECTRODES

HI1043B

Glass-body, double junction, refillable, combination pH electrode

Use: strong acid and base, paint and solvents

HI1053B

Glass-body, triple ceramic, conic shape, refillable, combination pH electrode

Use: emulsions, fats and creams, soil and semi-solids samples

HI1083B

Glass-body, micro, Viscolene, nonrefillable, combination pH electrode

Use: biotechnology and micro titration

HI1131B

Glass-body, double junction, refillable, combination pH electrode

Use: general purpose

HI1330B

Glass-body, semimicro, single junction, refillable, combination pH electrode

Use: laboratory, vials, and test tubes

HI1331B

Glass-body, semimicro, single junction, refillable, combination pH electrode

Use: flasks

HI1230B

Plastic-body (PEI), double junction, gel-filled, combination pH electrode

Use: general purpose

HI2031B

Glass-body, conical tip, refillable, combination pH electrode

Use: dairy and semi-solid products

HI1332B

Plastic-body (PEI), double junction, refillable, combination pH electrode

Use: chemicals, field applications and quality control testing

FC100B

Plastic-body (PVDF), double junction, refillable, combination pH electrode

Use: cheese

FC200B

Plastic-body (PVDF), single junction, conical tip, non-refillable Viscolene electrolyte, combination pH electrode

Use: milk, yogurt, dairy products, and semi-solid foods

FC210B

Glass-body, double junction, conical tip, non-refillable Viscolene electrolyte, combination pH electrode

Use: milk, yogurt, and cream

FC220B

Glass-body, single junction, refillable, combination pH electrode

Use: milk, yogurt, cream, sauce, and fruit juices

FC911B

Plastic-body (PVDF), double junction, refillable, combination pH electrode

Use: sauce, juices, dairy products and other liquid or slurry forms of food

HI1413B

Glass-body, single junction, flat tip, non-refillable Viscolene electrolyte, combination pH electrode

Use: surfaces, skin, leather, paper, and emulsions

11.2.2. ORP ELECTRODES

HI3131B

Glass-body, refillable, combination platinum ORP electrode

Use: laboratories and general purpose

HI3230B

Plastic-body (PEI), gel-filled, combination platinum ORP electrode

Use: municipal water and quality control

HI4430B

Plastic-body (PEI), gel-filled, combination gold ORP electrode

Use: oxidants and ozone

11.2.3. HALF-CELL ELECTRODES

HI2110B

Glass-body, single half-cell pH electrode

Use: general purpose

HI5311

Glass-body, silver / silver chloride (Ag / AgCl) reference half-cell electrode, double junction, refillable with 4mm banana plug with 1m (3.3') cable

Use: general purpose with wide temperature range

HI5315

Plastic-body (PEI), double junction, silver / silver chloride (Ag / AgCl) reference half-cell electrode, refillable with 4mm plug with 1 m (3.3') cable.

Use: Ion-Selective Electrodes

HI5412

Glass-body, single Calomel reference half-cell electrode, refillable with 4mm plug with 1m (3.3') cable

Use: general purpose with constant temperature range

11.2.4. ION-SELECTIVE ELECTRODES

HI4101	Ammonia ion selective electrode
HI4002 / HI4102	Bromide ion selective electrode
HI4003 / HI4103	Cadmium ion selective electrode
HI4004 / HI4104	Chloride ion selective electrode
HI4105	Carbon dioxide ion selective electrode

HI4007 / HI4107	Chloride ion selective electrode
HI4008 / HI4108	Cupric ion selective electrode
HI4009 / HI4109	Cyanide ion selective electrode
HI4010 / HI4110	Fluoride ion selective electrode
HI4011 / HI4111	Iodide ion selective electrode
HI4012 / HI4112	Lead ion selective electrode
HI4013 / HI4113	Nitrate ion selective electrode
HI4014 / HI4114	Potassium ion selective electrode
HI4015 / HI4115	Silver / Sulfide ion selective electrode
FC300B	Sodium electrode

11.2.5. TEMPERATURE SENSOR

HI7662-TW

Temperature probe with 1 m (3.3') paneled cable

11.3. TITRATOR COMPONENTS

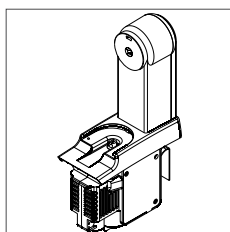

Pump assembly
HI930100

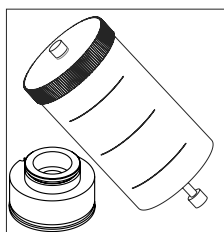

50 mL Syringe
HI900250

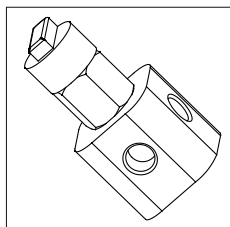

3 Way valve
HI900260

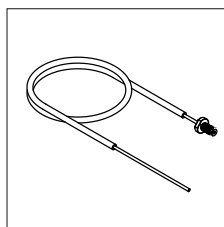

Aspiration tube with fitting and
protection tube
HI900270

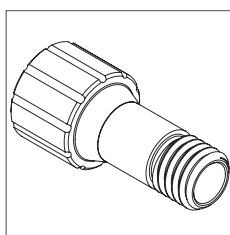

Tool for burette cap removal
HI900942

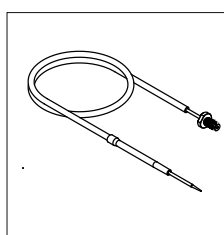

Dispensing tube with dispensing
tip, fitting, protection tube and
tube guide
HI930280

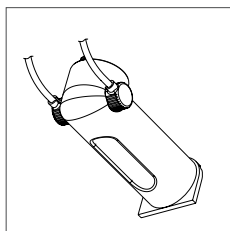

Burette with:
5 mL syringe - HI930105
10 mL syringe - HI930110
25 mL syringe - HI930125
50 mL syringe - HI930150

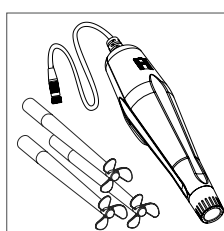

Overhead stirrer &
3 propellers
HI930301

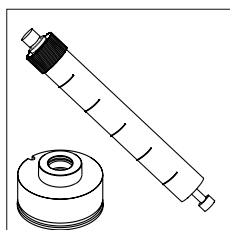

5 mL Syringe
HI900205

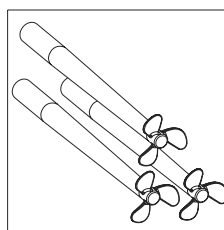

Replacement propellers
(3 pcs.)
HI930302

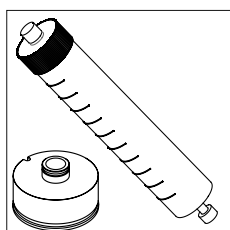

10 mL Syringe
HI900210

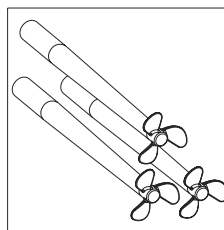

High chemical resistance
propellers
(3 pcs.)
HI930303

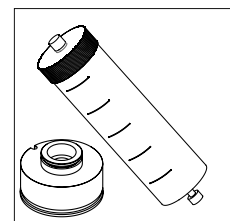

25 mL Syringe
HI900225

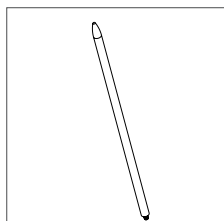

Stirrer support
HI930320

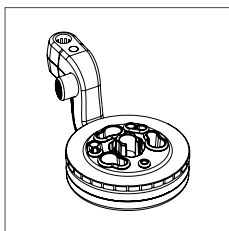

Overhead electrode holder
HI930310

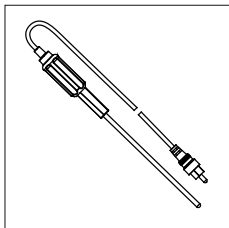

Temperature probe
HI7662-TW

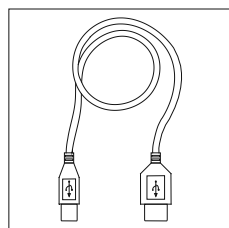

USB Cable
HI920013

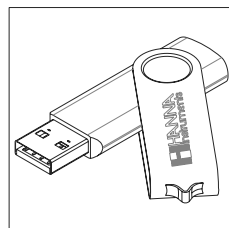

USB Storage device
HI930900U

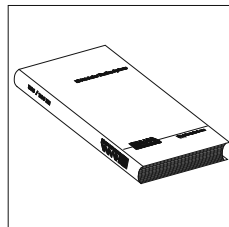

Instruction manual binder
HI930800

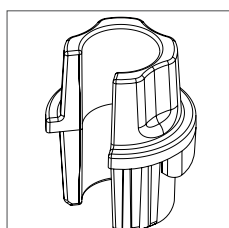

Electrode adapter for
overhead stirrer holder
HI930311

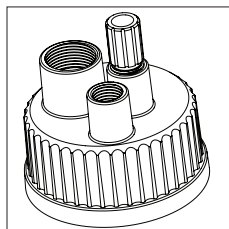

Titrant bottle cap assembly
HI930330

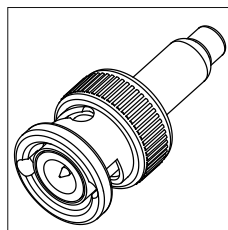

Shorting cap
HI900945

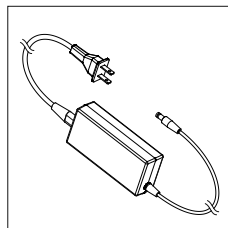

Power adapter (usa plug)
HI900946

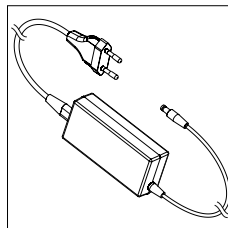

Power adapter (european plug)
HI900947

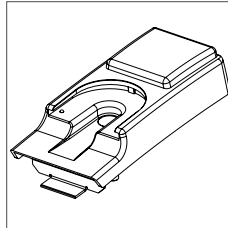

Blank burette support
HI930190

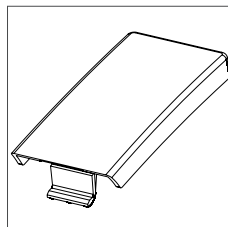

Blank support
HI930191

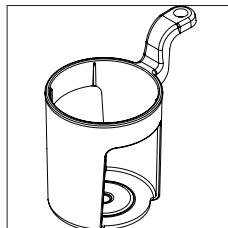

Titrant bottle holder
HI930315

PART 3:

APPLICATIONS



HI0001EN 0.1N SODIUM HYDROXIDE TITRANT CONCENTRATION

DESCRIPTION

Method for the standardization (titer determination) of 0.1N Sodium Hydroxide (NaOH) titrant solution against Potassium Hydrogen Phthalate (KHP). The results are expressed in **N (eq/L)**.

REFERENCE

AOAC Official Methods of Analysis, Official Method 936.16

ELECTRODE

- HI1131B Combination pH Electrode
- HI7662-T Temperature Probe

REAGENTS

- HI70456 0.1N Sodium Hydroxide (1 L)
- HI70401 Potassium Hydrogen Phthalate (20 g)
- HI70436 Deionized Water (1 gal)

ACCESSORIES

- HI70300L Storage Solution (500 mL)
- HI7071 Electrode Fill Solution (30 mL x 4)
- HI7004L pH 4.01 Buffer Solution (500 mL)
- HI7007L pH 7.01 Buffer Solution (500 mL)
- HI7010L pH 10.01 Buffer Solution (500 mL)
- HI740036P 100 mL Plastic Beaker (10 pcs)
- Analytical Balance with 0.0001 g resolution

DEVICE PREPARATION

- Connect the pH electrode and temperature probe to the titrator.
- Install a 25 mL burette filled with 0.1N sodium hydroxide (HI70456) on pump one and verify that no air bubbles are present in the burette or tubing. If necessary prime the burette until all the air has been removed completely.
- Press Select Method from the main screen. Use the arrow keys to highlight *HI0001EN 0.1N Sodium Hydroxide* and press Select.

ELECTRODE PREPARATION

- Press Mode from the main screen, if necessary select the analog board and press pH.
- Calibrate the electrode using pH 4.01, 7.01 and 10.01 buffers. Refer to the instruction manual for calibration procedure.

SAMPLE PREPARATION

- Crush approximately 3 grams of potassium hydrogen phthalate (HI70401) and dry it for 2 hours at 120°C. Cool to room temperature in a desiccator.
- Place a clean 100 mL plastic beaker on the analytical balance.
- Zero the balance.
- Carefully weigh approximately 0.20 grams of dried potassium hydrogen phthalate into the beaker. Ensure that all of the potassium hydrogen phthalate is on the bottom of the beaker.
- Record the exact weight of the sample once the balance has stabilized with an accuracy of 0.0001 grams.
- Remove the beaker from the balance and add deionized water to the 50 mL mark on the beaker.

ANALYSIS

- Place the beaker under the stirrer assembly and lower it to immerse the pH electrode, temperature probe and stirrer. Ensure that the reference junction of the pH electrode is 5 to 6 mm below the surface. If necessary add extra deionized water.

Note: *The dispensing tip should be slightly submerged in the sample.*

- Press start stop. You will be prompted to enter the weight of the analyte (weight of potassium hydrogen phthalate). Use the numeric keypad to enter the exact weight and press enter to start the analysis.

Note: *Ensure that the potassium hydrogen phthalate dissolves completely during the pre-titration stir time. Erroneous results may occur if the sample does not dissolve completely prior to titration. If necessary the pre-titration stir time can be increased.*

- At the end of the titration, after detection of the equivalence point, "Titration Completed" will appear with the result. The result is expressed in **N (eq/L) of sodium hydroxide**.
- Remove the pH electrode, temperature probe and stirrer from the sample and rinse them thoroughly with deionized water.
- Record the result.

Note: For improved accuracy, repeat this procedure a minimum of three times and calculate the average value.

For methods utilizing 0.1N sodium hydroxide titrant solution, follow the steps below to enter the titer/standardized value.

- Select the method utilizing 0.1N sodium hydroxide.
- Press from the main screen.

METHOD PARAMETERS

Name: 0.1N Sodium Hydroxide
 Method Revision: 3.0
 Stirrer Configuration:
 Stirrer: Stirrer 1
 Stirring Speed: 1400 RPM
 Pump Configuration:
 Titrant Pump: Pump 1
 Dosing Type: Dynamic
 Min Vol: 0.030 mL
 Max Vol: 0.500 mL
 delta E: 4.500 mV
 End Point Mode:pH 1EQ point, 1st Der
 Recognition Options:
 Threshold: 500 mV/mL
 Range: NO
 Filtered Derivatives: NO
 Pre-Titration Volume: 5.000 mL
 Pre-Titration Stir Time: 60 sec
 Measurement Mode: Signal Stability
 delta E: 0.3 mV
 delta t: 2 sec
 Min wait: 3 sec
 Max wait: 30 sec
 Electrode Type: pH
 Blank Option: No Blank
 Calculations:Stdz. Titrant by Weight
 Dilution Option: Disabled
 Titrant Name: 0.1N NaOH
 Analyte Size: 0.20000 g
 Analyte Entry: Manual
 Maximum Titrant Volume: 15.000 mL
 Potential Range:-2000.0 to 2000.0 mV
 Volume/Flow Rate: 25 mL/50.0 mL/min
 Signal Averaging: 1 Reading
 Significant Figures: XXXXX

- Using the arrow keys, highlight Titrant Conc. and press .
- Use the numeric keypad to enter the standardized (titer) value of the titrant then press .
- Press to exit the **View/Modify Method** screen. Use the arrow keys to highlight **Save Method** and press .

CALCULATIONS

Calculations:Stdz. Titrant by Weight
 Titrant units: N (eq/L)
 Titrant volume dosed: V (L)
 Standard weight: 0.200 g
 mw of standard: 204.23 g/mol
 Titrant/Standard: 1.000 eq/mol

$$\frac{\text{eq}}{\text{L}} \text{ NaOH} = \frac{0.200 * 1.000}{204.23 * \text{V(L)}}$$

RESULTS

Titration Report

Method Name: 0.1N Sodium Hydroxide
 Time & Date: 17:03 Jun 07, 2018
 Report ID: Ti_00053

Titration Results

Method Name: 0.1N Sodium Hydroxide
 Time & Date: 17:03 Jun 07, 2018
 Analyte Size: 0.20920 g
 End Point Volume: 10.215 mL
 pH Equivalence Point: 8.394
 Result: 0.10027 N(eq/L)
 Initial & Final pH: 4.173 to 9.570
 Titration Duration: 6:25 [mm:ss]
 Titration went to Completion

Analyst Signature: _____

HI0002EN 0.1N HYDROCHLORIC ACID TITRANT CONCENTRATION

DESCRIPTION

Method for the standardization (titer determination) of 0.1N Hydrochloric Acid (HCl) titrant solution against Sodium Hydroxide (NaOH). The results are expressed in **N (eq/L)**.

REFERENCE

AOAC Official Methods of Analysis, Official Method 936.15

ELECTRODE

- HI1131B Combination pH Electrode
- HI7662-T Temperature Probe

REAGENTS

- HI70463 0.1N Hydrochloric Acid (1 L)
- HI70456 0.1N Sodium Hydroxide (1 L)
- HI70436 Deionized Water (1 gal)

ACCESSORIES

- HI70300L Storage Solution (500 mL)
- HI7071 Electrode Fill Solution (30 mL x 4)
- HI7004L pH 4.01 Buffer Solution (500 mL)
- HI7007L pH 7.01 Buffer Solution (500 mL)
- HI7010L pH 10.01 Buffer Solution (500 mL)
- HI740036P 100 mL Plastic Beaker (10 pcs)
- 10 mL Class A Volumetric Pipette

DEVICE PREPARATION

- Connect the pH electrode and temperature probe to the titrator.
- Install a 25 mL burette filled with 0.1N hydrochloric acid (HI70453) on pump one and verify that no air bubbles are present in the burette or tubing. If necessary prime the burette until all the air has been removed completely.
- Press from the main screen. Use the arrow keys to highlight *HI0002EN 0.1N Hydrochloric Acid* and press .

ELECTRODE PREPARATION

- Press from the main screen, if necessary select the analog board and press .
- Calibrate the electrode using pH 4.01, 7.01 and 10.01 buffers. Refer to the instruction manual for calibration procedure.

SAMPLE PREPARATION

- Use a Class A volumetric pipette to transfer exactly 10.00 mL of 0.1N sodium hydroxide (HI70456) to a clean 100 mL beaker
- Add deionized water to the 50 mL mark on the beaker.

ANALYSIS

- Place the beaker under the stirrer assembly and lower it to immerse the pH electrode, temperature probe and stirrer. Ensure that the reference junction of the pH electrode is 5 to 6 mm below the surface. If necessary add extra deionized water.

Note: *The dispensing tip should be slightly submerged in the sample.*

- Press . The titrator start the analysis.
- At the end of the titration, after detection of the equivalence point, "Titration Completed" will appear with the result. The result is expressed in **N (eq/L) of hydrochloric acid**.
- Remove the pH electrode, temperature probe and stirrer from the sample and rinse them thoroughly with deionized water.
- Record the result.

Note: *For improved accuracy, repeat this procedure a minimum of three times and calculate the average value.*

For methods utilizing 0.1N hydrochloric acid titrant solution, follow the steps below to enter the titer/standardized value.

- Select the method utilizing 0.1N hydrochloric acid.
- Press from the main screen.
- Using the arrow keys, highlight Titrant Conc. and press .
- Use the numeric keypad to enter the standardized (titer) value of the titrant then press .
- Press to exit the **View/Modify Method** screen. Use the arrow keys to highlight *Save Method* and press .

METHOD PARAMETERS

Name: 0.1N Hydrochloric Acid
 Method Revision: 3.0
 Stirrer Configuration:
 Stirrer: Stirrer 1
 Stirring Speed: 1400 RPM
 Pump Configuration:
 Titrant Pump: Pump 1
 Dosing Type: Dynamic
 Min Vol: 0.030 mL
 Max Vol: 0.500 mL
 delta E: 6.000 mV
 End Point Mode:pH 1EQ point, 1st Der
 Recognition Options:
 Threshold: 500 mV/mL
 Range: NO
 Filtered Derivatives: NO
 Pre-Titration Volume: 5.000 mL
 Pre-Titration Stir Time: 0 sec
 Measurement Mode: Signal Stability
 delta E: 1.0 mV
 deltat: 2 sec
 Min wait: 3 sec
 Max wait: 15 sec
 Electrode Type: pH
 Blank Option: No Blank
 Calculations:Stdz. Titrant by Volume
 Dilution Option: Disabled
 Titrant Name: 0.1N HCl
 Analyte Size: 10.0000 mL
 Analyte Entry: Fixed
 Maximum Titrant Volume: 15.000 mL
 Potential Range:-2000.0 to 2000.0 mV
 Volume/Flow Rate: 25 mL/50.0 mL/min
 Signal Averaging: 1 Reading
 Significant Figures: XXXXX

CALCULATIONS

Calculations:Stdz. Titrant by Volume
 Titrant units: N (eq/L)
 Titrant volume dosed: V (L)
 Standard volume: 10.000 mL
 Standard conc.: 0.100 eq/L

$$\frac{\text{eq}}{\text{L}} \text{HCl} = \frac{10.000 * 0.100}{V(\text{L}) * 1000}$$

RESULTS

Titration Report

Method Name: 0.1N Hydrochloric Acid
 Time & Date: 14:55 July 30, 2018
 Report ID: Ti_00002

Titration Results

Method Name: 0.1N Hydrochloric Acid
 Time & Date: 14:55 July 30, 2018
 Analyte Size: 10.000 mL
 End Point Volume: 9.979 mL
 pH Equivalence Point: 5.059
 Result: 0.10020 N(eq/L)
 Initial & Final pH: 12.135 to 4.989
 Titration Duration: 2:45 [mm:ss]
 Titration went to Completion

Analyst Signature: _____

HI0003EN 0.1M SODIUM THIOSULFATE TITRANT CONCENTRATION

DESCRIPTION

Method for the standardization (titer determination) of 0.1M Sodium Thiosulfate ($\text{Na}_2\text{S}_2\text{O}_3$) titrant solution against Potassium Iodate (KIO_3). The results are expressed in **M (mol/L)**.

REFERENCE

Standard Methods for the Examination of Water and Wastewater 19th Edition, Method 4500-Cl B

ELECTRODE

- HI3131B Combination ORP Electrode



REAGENTS

- HI70439 0.1M Sodium Thiosulfate (1 L)
- HI70407 Potassium Iodate (20 g)
- HI70425 16% Sulfuric Acid (500 mL)
- HI70468 Potassium Iodide (35 g)
- HI70436 Deionized Water (1 gal)

ACCESSORIES

- HI70300L Storage Solution (500 mL)
- HI7071 Electrode Fill Solution (30 mL x 4)
- HI740036P 100 mL Plastic Beakers (10 pcs)
- Analytical Balance 0.0001 g
- 100 mL Class A Volumetric Flask
- 10 mL Class A Volumetric Pipette

DEVICE PREPARATION

- Connect the ORP electrode to the titrator.
- Install a 25 mL burette filled with 0.1M sodium thiosulfate (HI70439) on pump one and verify that no air bubbles are present in the burette or tubing. If necessary prime the burette until all the air has been removed completely.
- Press  from the main screen. Use the arrow keys to highlight *HI0003EN 0.1M Sodium Thiosulfate* and press .

ELECTRODE PREPARATION

- Prepare the ORP electrode according to the procedure in the manual.

SAMPLE PREPARATION



- Crush approximately 2 grams of potassium iodate (HI70407) and dry it for 2 hours at 120°C. Cool to room temperature in a desiccator.

- Carefully weigh approximately 0.35 grams of dried potassium iodate.
- Record the exact weight of the sample once the balance has stabilized with an accuracy of 0.0001 grams.
- Carefully transfer the salt to a 100 mL Class A volumetric flask. Add approximately 80 mL of deionized water, and mix to dissolve. Once the salt is completely dissolved bring the flask to volume with deionized water, mix well.
- Use a Class A volumetric pipette to transfer exactly 10.00 mL of the solution to a clean 100 mL plastic beaker.
- Add deionized water to the 50 mL mark on the beaker.
- Add 5.00 mL of 16% sulfuric acid (HI70425) and 1.5 grams of potassium iodide (HI70468) to the beaker.

ANALYSIS

- Place the beaker under the stirrer assembly and lower it to immerse the ORP electrode and stirrer. Ensure that the reference junction of the ORP electrode is 5 to 6 mm below the surface. If necessary add extra deionized water.

Note: *The dispensing tip should be slightly submerged in the sample.*

- Press . You will be prompted to enter the weight of the analyte (weight of potassium iodate). Use the numeric keypad to enter the exact weight and press  to start the analysis.
- At the end of the titration, after detection of the equivalence point, "Titration Completed" will appear with the result. The result is expressed in **M (mol/L) of sodium thiosulfate**.
- Remove the ORP electrode and stirrer from the sample and rinse them thoroughly with deionized water.
- Record the result.

Note: *For improved accuracy, repeat this procedure a minimum of three times and calculate the average value.*

For methods utilizing 0.1M sodium thiosulfate titrant solution, follow the steps below to enter the titer/standardized value.

- Select the method utilizing 0.1M sodium thiosulfate.
- Press **Method Options** from the main screen.
- Using the arrow keys, highlight Titrant Conc. and press **Select**.

METHOD PARAMETERS

Name: 0.1M Sodium Thiosulfate
 Method Revision: 3.0
 Stirrer Configuration:
 Stirrer: Stirrer 1
 Stirring Speed: 1400 RPM
 Pump Configuration:
 Titrant Pump: Pump 1
 Dosing Type: Dynamic
 Min Vol: 0.030 mL
 Max Vol: 0.600 mL
 delta E: 6.500 mV
 End Point Mode:mV 1EQ point, 1st Der
 Recognition Options:
 Threshold: 50 mV/mL
 Range: NO
 Filtered Derivatives: NO
 Pre-Titration Volume: 5.000 mL
 Pre-Titration Stir Time: 0 sec
 Measurement Mode: Signal Stability
 delta E: 0.3 mV
 delta t: 2 sec
 Min wait: 2 sec
 Max wait: 20 sec
 Electrode Type: ORP
 Blank Option: No Blank
 Calculations:Stdz. Titrant by Weight
 Dilution Option: Enabled
 Final Dilution Volume: 100.000 mL
 Aliquot Volume: 10.000 mL
 Titrant Name: 0.1M Na2S2O3
 Analyte Size: 0.35000 g
 Analyte Entry: Manual
 Maximum Titrant Volume: 15.000 mL
 Potential Range:-2000.0 to 2000.0 mV
 Volume/Flow Rate: 25 mL/50.0 mL/min
 Signal Averaging: 1 Reading
 Significant Figures: XXXXXX

- Use the numeric keypad to enter the standardized (titer) value of the titrant then press **Accept**.
- Press **Escape** to exit the **View/Modify Method** screen. Use the arrow keys to highlight **Save Method** and press **Select**.

CALCULATIONS

Calculations:Stdz. Titrant by Weight
 Titrant units: M (mol/L)
 Titrant volume dosed: V (L)
 Standard weight: 0.350 g
 Dilution Factor: 0.100
 Final Dilution volume: 100.000 mL
 Aliquot Volume: 10.000 mL
 mw of standard: 214.00 g/mol
 Titrant/Standard: 6.000 mol/mol

$$\frac{\text{mol}}{\text{L}} \text{Na}_2\text{S}_2\text{O}_3 = \frac{0.350 * 0.10 * 6.0}{214.00 * V(L)}$$

RESULTS

Titration Report
 Method Name: 0.1M Sodium Thiosulfate
 Time & Date: 17:03 Jun 07, 2018
 Report ID: Ti_00073

Titration Results
 Method Name: 0.1M Sodium Thiosulfate
 Time & Date: 17:03 Jun 07, 2018
 Analyte Size: 0.35020 g
 End Point Volume: 9.635 mL
 mV Equivalence Point: 233.0
 Result: 0.10191 M (mol/L)
 Initial & Final mV: 361.8 to 173.4
 Titration Duration: 2:51 [mm:ss]
 Titration went to Completion

Analyst Signature: _____

HI0010EN 0.1M FERROUS AMMONIUM SULFATE TITRANT CONCENTRATION

DESCRIPTION

Method for the standardization (titer determination) of 0.1M Ferrous Ammonium Sulfate (FAS) titrant solution against Potassium Dichromate ($K_2Cr_2O_7$). The results are expressed in **M (mol/L)**.

REFERENCE

Standard Methods for the Examination of Water and Wastewater 21st Edition, Method 5220B

ELECTRODE

- HI3131B Combination ORP Electrode

REAGENTS

- HI70444 25% Sulfuric Acid
- HI70436 Deionized Water (1 gal)
- Ferrous Ammonium Sulfate (ACS Grade)
- Potassium Dichromate (ACS Grade)

ACCESSORIES



- HI70300L Storage Solution (500 mL)
- HI7071 Electrode Fill Solution (30 mL x 4)
- HI740036P 100 mL Plastic Beakers (10 pcs)
- Analytical Balance with 0.0001 g resolution
- 100 mL Class A Volumetric Flask
- 500 mL Class A Volumetric Flask
- 10 mL Class A Volumetric Pipette

TITRANT PREPARATION

- Carefully weigh 19.607 grams of ferrous ammonium sulfate.
- Carefully transfer the salt to a 500 mL Class A volumetric flask. Add approximately 300 mL of deionized water, and mix to dissolve.
- Add 40.00 mL of 25% sulfuric acid (HI70444) to the flask. Invert the solution to mix.
- Allow the flask to return to room temperature.
- Bring the flask to volume with deionized water, mix well.

DEVICE PREPARATION

- Connect the ORP electrode to the titrator.
- Install a 25 mL burette filled with 0.1M ferrous ammonium sulfate on pump one and verify that no air bubbles are present in the burette or tubing. If necessary prime the burette until all the air has been removed completely.

- Press  from the main screen. Use the arrow keys to highlight *HI0010EN 0.1M FAS* and press .

ELECTRODE PREPARATION

- Prepare the ORP electrode according to the procedure in the manual.



SAMPLE PREPARATION

- Carefully weigh approximately 0.49 grams of dried potassium dichromate.
- Record the exact weight of the sample once the balance has stabilized with an accuracy of 0.0001 grams.
- Carefully transfer the salt to a 100 mL Class A volumetric flask. Add approximately 80 mL of deionized water, and mix to dissolve. Once the salt is completely dissolved bring the flask to volume with deionized water, mix well.
- Use a Class A volumetric pipette to transfer exactly 10.00 mL of the solution to a clean 100 mL plastic beaker.
- Add 25.00 mL of 25% sulfuric acid (HI70444) to the beaker.
- Add deionized water to the 50 mL mark on the beaker.

ANALYSIS

- Place the beaker under the stirrer assembly and lower it to immerse the electrode and stirrer. Ensure that the reference junction of the ORP electrode is 5 to 6 mm below the surface. If necessary add extra deionized water.

Note: *The dispensing tip should be slightly submerged in the sample.*

- Press . You will be prompted to enter the weight of the analyte (weight of potassium dichromate). Use the numeric keypad to enter the exact weight and press  to start the analysis.
- At the end of the titration, after detection of the equivalence point, "Titration Completed" will appear with the result. The result is expressed in **M (mol/L) of ferrous ammonium sulfate**.
- Remove the ORP electrode and stirrer from the sample and rinse them thoroughly with deionized water.

- Record the result.

Note: For improved accuracy, repeat this procedure a minimum of three times and calculate the average value.

For methods utilizing 0.1M ferrous ammonium sulfate titrant solution, follow the steps below to enter the titer/standardized value.

- Select the method utilizing 0.1M ferrous ammonium sulfate.

- Press **Method Options** from the main screen.
- Using the arrow keys, highlight Titrant Conc. and press **Select**.
- Use the numeric keypad to enter the standardized (titer) value of the titrant then press **Accept**.
- Press **Escape** to exit the **View/Modify Method** screen. Use the arrow keys to highlight **Save Method** and press **Select**.

METHOD PARAMETERS

```
Name: 0.1M FAS
Method Revision: 3.0
Stirrer Configuration:
  Stirrer: Stirrer 1
  Stirring Speed: 1400 RPM
Pump Configuration:
  Titrant Pump: Pump 1
Dosing Type: Dynamic
  Min Vol: 0.030 mL
  Max Vol: 0.500 mL
  delta E: 4.500 mV
End Point Mode:mV 1EQ point, 1st Der
Recognition Options:
  Threshold: 35 mV/mL
  Range: NO
  Filtered Derivatives: NO
Pre-Titration Volume: 5.000 mL
Pre-Titration Stir Time: 0 sec
Measurement Mode: Signal Stability
  delta E: 0.5 mV
  delta t: 3 sec
  Min wait: 2 sec
  Max wait: 20 sec
Electrode Type: ORP
Blank Option: No Blank
Calculations:Stdz. Titrant by Weight
Dilution Option: Enabled
  Final Dilution Volume: 100.000 mL
  Aliquot Volume: 10.000 mL
Titrant Name: 0.1M FAS
Analyte Size: 0.49000 g
Analyte Entry: Manual
Maximum Titrant Volume: 15.000 mL
Potential Range:-2000.0 to 2000.0 mV
Volume/Flow Rate: 25 mL/50.0 mL/min
Signal Averaging: 1 Reading
Significant Figures: XXXXX
```

CALCULATIONS

```
Calculations:Stdz. Titrant by Weight
Titrant units: M (mol/L)
Titrant volume dosed: V (L)
Standard weight: 0.490 g
Dilution Factor: 0.100
  Final Dilution volume: 100.000 mL
  Aliquot Volume: 10.000 mL
mw of standard: 294.18 g/mol
Titrant/Standard: 6.000 mol/mol
```

$$\frac{\text{mol}}{\text{L}} \text{ FAS} = \frac{0.490 * 0.10 * 6.0}{294.18 * V(L)}$$

RESULTS

```
Titration Report
Method Name: 0.1M FAS
Time & Date: 15:59 August 1, 2018
Report ID: Ti_00015
```

```
Titration Results
Method Name: 0.1M FAS
Time & Date: 15:59 August 1, 2018
Analyte Size: 0.491 g
End Point Volume: 9.879 mL
mV Equivalence Point: 667.4
Result: 0.10137 M (mol/L)
Initial & Final mV: 791.3 to 598.0
Titration Duration: 3:05 [mm:ss]
Titration went to Completion
```

Analyst Signature: _____

HI0200EN 0.02M SILVER NITRATE TITRANT CONCENTRATION

DESCRIPTION

Method for the standardization (titer determination) of 0.02M Silver Nitrate (AgNO_3) titrant solution against Sodium Chloride (NaCl). The results are expressed in **M (mol/L)**.

REFERENCE

AOAC Official Methods of Analysis, Official Method 941.18

ELECTRODE

- HI4115 Silver/Sulfide Combination ISE



REAGENTS

- HI70448 0.02M Silver Nitrate (1 L)
- HI70406 Sodium Chloride (20 g)
- HI70427 1.5M Nitric Acid Solution (500 mL)
- HI70436 Deionized Water (1 gal)

ACCESSORIES

- HI7072 Electrode Fill Solution (4 x 30 mL)
- Analytical Balance with 0.0001 g resolution
- 150 mL Glass Beaker
- 100 mL Class A Volumetric Flask
- 5 mL Class A Volumetric Pipette

DEVICE PREPARATION

- Connect the Silver/Sulfide electrode to the titrator.
- Install a 25 mL burette filled with 0.02M silver nitrate (HI70448) on pump one and verify that no air bubbles are present in the burette or tubing. If necessary prime the burette until all the air has been removed completely.
- Press  from the main screen. Use the arrow keys to highlight *HI0200EN 0.02M Silver Nitrate* and press .

ELECTRODE PREPARATION

- Prepare the Silver/Sulfide electrode according to the procedure in the manual.

SAMPLE PREPARATION



- Crush approximately 2 grams of sodium chloride (HI70406) and dry it for 2 hours at 140°C. Cool to room temperature in a desiccator.
- Weigh 0.20 g of dried sodium chloride with an accuracy of 0.0001 g. Transfer the salt to a 100 mL volumetric flask. Add approximately 80 mL of distilled water and mix. Dissolve completely before bringing to volume.

- Use a Class A volumetric pipette to transfer exactly 5.00 mL of prepared standard solution to a 150 mL glass beaker and add distilled water to the 100 mL mark on the beaker.
- Add 10.00 mL of 1.5M nitric acid (HI70427) to the beaker.

ANALYSIS





- Place the beaker under the stirrer assembly and lower it to immerse the Silver/Sulfide electrode and stirrer. Ensure that the reference junction of the electrode is 5 to 6 mm below the surface. If necessary add extra deionized water.

Note: *The dispensing tip should be slightly submerged in the sample.*

- Press . You will be prompted to enter the weight of the analyte (weight of sodium chloride). Use the numeric keypad to enter the exact weight and press  to start the analysis.
- At the end of the titration, after detection of the equivalence point, "Titration Completed" will appear with the result. The result is expressed in **M (mol/L) of silver nitrate**.
- Remove the electrode and stirrer from the sample and rinse them thoroughly with deionized water.
- Record the result.

Note: *For improved accuracy, repeat this procedure a minimum of three times and calculate the average value.*

For methods utilizing 0.02M silver nitrate titrant solution, follow the steps below to enter the titer/standardized value.

- Select the method utilizing 0.02M silver nitrate.
- Press  from the main screen.
- Using the arrow keys, highlight Titrant Conc. and press .
- Use the numeric keypad to enter the standardized (titer) value of the titrant then press .
- Press  to exit the **View/Modify Method** screen. Use the arrow keys to highlight *Save Method* and press .

METHOD PARAMETERS

Name: 0.02M Silver Nitrate
 Method Revision: 3.0
 Stirrer Configuration:
 Stirrer: Stirrer 1
 Stirring Speed: 1400 RPM
 Pump Configuration:
 Titration Pump: Pump 1
 Dosing Type: Dynamic
 Min Vol: 0.030 mL
 Max Vol: 0.500 mL
 delta E: 8.000 mV
 End Point Mode:mV 1EQ point, 1st Der
 Recognition Options:
 Threshold: 100 mV/mL
 Range: NO
 Filtered Derivatives: YES
 Pre-Titration Volume: 6.000 mL
 Pre-Titration Stir Time: 0 sec
 Measurement Mode: Signal Stability
 delta E: 1.0 mV
 delta t: 2 sec
 Min wait: 2 sec
 Max wait: 20 sec
 Electrode Type: Silver/Sulfide
 Blank Option: No Blank
 Calculations:Stdz. Titrant by Weight
 Dilution Option: Enabled
 Final Dilution Volume: 100.000 mL
 Aliquot Volume: 5.000 mL
 Titrant Name: 0.02M AgNO3
 Analyte Size: 0.20000 g
 Analyte Entry: Manual
 Maximum Titrant Volume: 15.000 mL
 Potential Range:-2000.0 to 2000.0 mV
 Volume/Flow Rate: 25 mL/50.0 mL/min
 Signal Averaging: 1 Reading
 Significant Figures: XXXXX

CALCULATIONS

Calculations:Stdz. Titrant by Weight
 Titrant units: M (mol/L)
 Titrant volume dosed: V (L)
 Standard weight: 0.200 g
 Dilution Factor: 0.05
 Final Dilution volume: 100.000 mL
 Aliquot Volume: 5.000 mL
 mw of standard: 58.440 g/mol
 Titrant/Standard: 1.000 mol/mol

$$\frac{\text{mol}}{\text{L}} \text{AgNO}_3 = \frac{0.200 * 0.05 * 1.0}{58.440 * V(L)}$$

RESULTS

Titration Report

Method Name: 0.02M Silver Nitrate
 Time & Date: 15:52 August 1, 2018
 Report ID: Ti_00037

Titration Results

Method Name: 0.02M Silver Nitrate
 Time & Date: 15:52 August 1, 2018
 Analyte Size: 0.1923 g
 End Point Volume: 9.065 mL
 mV Equivalence Point: 273.1
 Result: 0.01815 M (mol/L)
 Initial & Final mV: 146.9 to 291.0
 Titration Duration: 2:21 [mm:ss]
 Titration went to Completion

Analyst Signature: _____

HI1004EN ALKALINITY OF WATER

0 to 2500 mg/L CaCO₃, pH 4.5 Endpoint

DESCRIPTION

Method for the determination of total (methyl red) alkalinity in water by titration of a sample to pH 4.5. The results are expressed in **mg/L (ppm) as calcium carbonate**.

For the determination of phenolphthalein alkalinity, set the endpoint to pH 8.3.

REFERENCE

Standard Methods for the Examination of Water and Wastewater 21st edition, Method 2320B

ELECTRODE

- HI1131B Combination pH Electrode
- HI7662-T Temperature Probe

REAGENTS

- HI70463 0.1N Hydrochloric Acid (1 L)
- HI70436 Deionized Water (1 gal)

ACCESSORIES

- HI70300L Storage Solution (500 mL)
- HI7082 Electrode Fill Solution (4 x 30 mL)
- HI7004L pH 4.01 Buffer Solution (500 mL)
- HI7007L pH 7.01 Buffer Solution (500 mL)
- HI7010L pH 10.01 Buffer Solution (500 mL)
- HI740036P 100 mL Plastic Beaker (10 pcs)
- 50 mL Class A Volumetric Pipette

DEVICE PREPARATION

- Connect the pH electrode and temperature probe to the titrator.
- Install a 25 mL burette filled with 0.1N hydrochloric acid (HI70463) on pump one and verify that no air bubbles are present in the burette or tubing. If necessary prime the burette until all the air has been removed completely.
- For the determination of the exact concentration of the 0.1N hydrochloric acid, follow *HI0002EN 0.1N Hydrochloric Acid Titrant Concentration*.
- Press from the main screen. Use the arrow keys to highlight *HI1004EN Alkalinity of Water* and press .

ELECTRODE PREPARATION

- Press from the main screen, if necessary select the analog board and press .
- Calibrate the electrode using pH 4.01, 7.01 and 10.01 buffers. Refer to the instruction manual for calibration procedure.

SAMPLE PREPARATION

- Use a Class A volumetric pipette to transfer exactly 50.00 mL of sample to a clean 100 mL plastic beaker.

ANALYSIS

- Place the beaker under the stirrer assembly and lower it to immerse the pH electrode, temperature sensor and stirrer. Ensure that the reference junction of the pH electrode is 5 to 6 mm below the surface. If necessary add extra deionized water.

Note: *The dispensing tip should be slightly submerged in the sample.*

- Press . The titrator will start the analysis.
- At the end of the titration, when pH 4.50 is reached, "Titration Completed" will appear with the result. The result is expressed in **mg/L as calcium carbonate**.
- Remove the electrode and stirrer from the sample and rinse them thoroughly with deionized water.
- Record the result.

METHOD PARAMETERS

Name: Alkalinity of Water
 Method Revision: 3.0
 Stirrer Configuration:
 Stirrer: Stirrer 1
 Stirring Speed: 1400 RPM
 Pump Configuration:
 Titrant Pump: Pump 1
 Dosing Type: Dynamic
 Min Vol: 0.050 mL
 Max Vol: 0.500 mL
 delta E: 5.000 mV
 End Point Mode: Fixed 4.500 pH
 Pre-Titration Volume: 0.000 mL
 Pre-Titration Stir Time: 0 sec
 Measurement Mode: Signal Stability
 delta E: 1.0 mV
 delta t: 2 sec
 Min wait: 2 sec
 Max wait: 20 sec
 Electrode Type: pH
 Blank Option: No Blank
 Calculations: Sample Calc. by Volume
 Dilution Option: Disabled
 Titrant Name: 0.1N HCl
 Titrant Conc.: 0.1000 N(eq/L)
 Analyte Size: 50.000 mL
 Analyte Entry: Fixed
 Maximum Titrant Volume: 25.000 mL
 Potential Range: -2000.0 to 2000.0 mV
 Volume/Flow Rate: 25 mL/50.0 mL/min
 Signal Averaging: 1 Reading
 Significant Figures: XXXXX

CALCULATIONS

Calculations: Sample Calc. by Volume
 Titrant units: N (eq/L)
 Titrant volume dosed: V (L)
 Final result units: mg/L
 Titrant Conc.: 0.1000 N(eq/L)
 Sample/Titrant: 0.500 mol/eq
 mw of standard: 100.09 g/mol
 Sample Volume: 50.000 mL

$$\frac{\text{mg}}{\text{L}} \text{CaCO}_3 = \frac{V(\text{L}) * 1000 * 0.10 * 0.5 * 100.09 * 1000}{50.00}$$

RESULTS

Titration Report

Method Name: Alkalinity of Water
 Time & Date: 14:36 August 1, 2018
 Report ID: Ti_00036

Titration Results

Method Name: Alkalinity of Water
 Time & Date: 14:36 August 1, 2018
 Analyte Size: 50.000 mL
 End Point Volume: 9.336 mL
 pH Fixed End Point: 4.500
 Result: 934.44 mg/L
 Initial & Final pH: 10.232 to 4.419
 Titration Duration: 3:23 [mm:ss]
 Titration went to Completion

Analyst Signature: _____

HI1005EN ACIDITY OF WATER

0 to 2500 mg/L, pH 8.3 Endpoint

DESCRIPTION

Method for the determination of total (phenolphthalein) acidity in water by titration of a sample to pH 8.3. The results are expressed in **mg/L (ppm) as calcium carbonate**.

For the determination of methyl orange acidity, set the endpoint to pH 3.7.

REFERENCE

Standard Methods for the Examination of Water and Wastewater 21st edition, Method 2310B

ELECTRODE

- HI1131B Combination pH Electrode
- HI7662-T Temperature Probe

REAGENTS

- HI70456 0.1N Sodium Hydroxide (1 L)
- HI70436 Deionized Water (1 gal)

ACCESSORIES

- HI70300L Storage Solution (500 mL)
- HI7082 Electrode Fill Solution (4 x 30 mL)
- HI7004L pH 4.01 Buffer Solution (500 mL)
- HI7007L pH 7.01 Buffer Solution (500 mL)
- HI7010L pH 10.01 Buffer Solution (500 mL)
- HI740036P 100 mL Plastic Beaker (10 pcs)
- 50 mL Class A Volumetric Pipette

DEVICE PREPARATION

- Connect the pH electrode and temperature probe to the titrator.
- Install a 25 mL burette filled with 0.1N sodium hydroxide (HI70456) on pump one and verify that no air bubbles are present in the burette or tubing. If necessary prime the burette until all the air has been removed completely.
- For the determination of the exact concentration of the 0.1N sodium hydroxide, follow *HI0001EN 0.1N Sodium Hydroxide* Titrant Concentration.
- Press **Select Method** from the main screen. Use the arrow keys to highlight *HI1005EN Acidity in Water* and press **Select**.

ELECTRODE PREPARATION

- Press **Mode** from the main screen, if necessary select the analog board and press **pH**.
- Calibrate the electrode using pH 4.01, 7.01 and 10.01 buffers. Refer to the instruction manual for calibration procedure.

SAMPLE PREPARATION

- Use a Class A volumetric pipette to transfer exactly 50.00 mL of sample to a clean 100 mL plastic beaker.

ANALYSIS

- Place the beaker under the stirrer assembly and lower it to immerse the pH electrode, temperature sensor and stirrer. Ensure that the reference junction of the pH electrode is 5 to 6 mm below the surface. If necessary add extra deionized water.

Note: *The dispensing tip should be slightly submerged in the sample.*

- Press **start stop**, the titrator will start the analysis.
- At the end of the titration, when pH 8.30 is reached, "Titration Completed" will appear with the result. The result is expressed in **mg/L as calcium carbonate**.
- Remove the pH electrode, temperature probe and stirrer from the sample and rinse them thoroughly with deionized water.
- Record the result.

METHOD PARAMETERS

Name: Acidity of Water
 Method Revision: 3.0
 Stirrer Configuration:
 Stirrer: Stirrer 1
 Stirring Speed: 1400 RPM
 Pump Configuration:
 Titrant Pump: Pump 1
 Dosing Type: Dynamic
 Min Vol: 0.050 mL
 Max Vol: 0.500 mL
 delta E: 5.000 mV
 End Point Mode: Fixed 8.300 pH
 Pre-Titration Volume: 0.000 mL
 Pre-Titration Stir Time: 0 sec
 Measurement Mode: Signal Stability
 delta E: 1.0 mV
 delta t: 2 sec
 Min wait: 2 sec
 Max wait: 20 sec
 Electrode Type: pH
 Blank Option: No Blank
 Calculations: Sample Calc. by Volume
 Dilution Option: Disabled
 Titrant Name: 0.1N NaOH
 Titrant Conc.: 0.1000 N(eq/L)
 Analyte Size: 50.000 mL
 Analyte Entry: Fixed
 Maximum Titrant Volume: 25.000 mL
 Potential Range: -2000.0 to 2000.0 mV
 Volume/Flow Rate: 25 mL/50.0 mL/min
 Signal Averaging: 1 Reading
 Significant Figures: XXXXX

CALCULATIONS

Calculations: Sample Calc. by Volume
 Titrant units: N (eq/L)
 Titrant volume dosed: V (L)
 Final result units: (mg/L)
 Titrant Conc.: 0.1000 N(eq/L)
 Sample/Titrant: 0.500 mol/eq
 mw of standard: 100.09 g/mol
 Sample Volume: 50.000 mL

$$\frac{\text{mg}}{\text{L}} \text{CaCO}_3 = \frac{V(\text{L}) * 1000 * 0.10 * 0.5 * 100.09 * 1000}{50.0}$$

RESULTS

Titration Report

Method Name: Acidity of Water
 Time & Date: 14:54 August 1, 2018
 Report ID: Ti_00023

Titration Results

Method Name: Acidity of Water
 Time & Date: 14:54 August 1, 2018
 Analyte Size: 50.000 mL
 End Point Volume: 5.879 mL
 pH Fixed End Point: 8.300
 Result: 588.43 (mg/L)
 Initial & Final pH: 2.465 to 8.398
 Titration Duration: 3:42 [mm:ss]
 Titration went to Completion

Analyst Signature: _____

HI1007EN CHLORIDE IN WATER

0 to 150 ppm (mg/L)

DESCRIPTION

Method for the determination of chloride in water. The results are expressed as **ppm (mg/L) as Chloride**.

REFERENCE

Standard Methods for the Examination of Water and Wastewater 21st edition, Method 4500-Cl

ELECTRODE

- HI4115 Silver/Sulfide Combination ISE



REAGENTS

- HI70448 0.02M Silver Nitrate (1 L)
- HI70427 1.5M Nitric Acid Solution (500 mL)
- HI70436 Deionized Water (1 gal)

ACCESSORIES

- HI7072 Electrode Fill Solution (4 x 30 mL)
- 150 mL Glass Beaker
- 100 mL Class A Volumetric Pipette
- 10 mL Class A Volumetric Pipette

DEVICE PREPARATION

- Connect the Silver/Sulfide electrode to the titrator.
- Install a 25 mL burette filled with 0.02M silver nitrate (HI70448) on pump one and verify that no air bubbles are present in the burette or tubing. If necessary prime the burette until all the air has been removed completely.
- For the determination of the exact concentration of the 0.02M Silver Nitrate, follow *HI0200EN 0.02M Silver Nitrate* Titrant Concentration.
- Press  from the main screen. Use the arrow keys to highlight *HI1007EN Chloride in Water* and press .

ELECTRODE PREPARATION

- Prepare the Silver/Sulfide electrode according to the procedure in the manual.

SAMPLE PREPARATION

- Use a class A volumetric pipette to transfer exactly 100.00 mL of sample to a clean 150 mL beaker.
- Add 10.00 mL of 1.5M nitric acid (HI70427) to the beaker.

ANALYSIS

- Place the beaker under the stirrer assembly and lower it to immerse the electrode and stirrer. Ensure that the reference junction of the electrode is 5 to 6 mm below the surface. If necessary add extra deionized water.

Note: *The dispensing tip should be slightly submerged in the sample.*

- Press , the titrator will start the analysis.
- At the end of the titration, after detection of the equivalence point, "Titration Completed" will appear with the result. The result is expressed in **ppm (mg/L) of chloride**.
- Remove the electrode and stirrer from the sample and rinse them thoroughly with deionized water.
- Record the result.

METHOD PARAMETERS

Name: Chloride in Water
 Method Revision: 3.0
 Stirrer Configuration:
 Stirrer: Stirrer 1
 Stirring Speed: 1400 RPM
 Pump Configuration:
 Titrant Pump: Pump 1
 Dosing Type: Dynamic
 Min Vol: 0.030 mL
 Max Vol: 0.500 mL
 delta E: 5.000 mV
 End Point Mode:mv 1EQ point, 1st Der
 Recognition Options:
 Threshold: 100 mV/mL
 Range: NO
 Filtered Derivatives: NO
 Pre-Titration Volume: 0.000 mL
 Pre-Titration Stir Time: 0 sec
 Measurement Mode: Signal Stability
 delta E: 1.0 mV
 delta t: 2 sec
 Min wait: 2 sec
 Max wait: 20 sec
 Electrode Type: Silver/Sulfide
 Blank Option: No Blank
 Calculations: Sample Calc. by Volume
 Dilution Option: Disabled
 Titrant Name: 0.02M AgNO3
 Titrant Conc.: 2.0000E-2 M (mol/L)
 Analyte Size: 100.000 mL
 Analyte Entry: Manual
 Maximum Titrant Volume: 25.000 mL
 Potential Range:-2000.0 to 2000.0 mV
 Volume/Flow Rate: 25 mL/50.0 mL/min
 Signal Averaging: 1 Reading
 Significant Figures: XXXXXX

CALCULATIONS

Calculations: Sample Calc. by Volume
 Titrant units: M (mol/L)
 Titrant volume dosed: V (L)
 Final result units: (mg/L)
 Titrant Conc.: 2.0000E-2 M (mol/L)
 Sample/Titrant: 1.000 mol/mol
 mw of sample: 35.453 g/mol
 Sample Volume: 100.000 mL

$$\frac{\text{mg}}{\text{L}} = \frac{\text{V(L)} * 1000 * 0.02 * 1.0 * 35.45 * 1000}{100.0}$$

RESULTS

Titration Report

Method Name: Chloride in Water
 Time & Date: 15:11 August 1, 2018
 Report ID: Ti_00052

Titration Results

Method Name: Chloride in Water
 Time & Date: 15:11 August 1, 2018
 Analyte Size: 100.000 mL
 End Point Volume: 4.781 mL
 mV Fixed End Point: 280.3
 Result: 33.897 ppm (mg/L)
 Initial & Final mV: 94.8 to 298.5
 Titration Duration: 1:24 [mm:ss]
 Titration went to Completion

Analyst Signature: _____

HI1008EN NEUTRALIZATION WITH SULFURIC ACID 0 to 200 meq/L

DESCRIPTION

Method for the determination of strong or weak base concentration by titration of a sample to the equivalence point with sulfuric acid. The results are expressed as **meq/L**.

ELECTRODE

- HI1131B Combination pH Electrode
- HI7662-T Temperature Probe



REAGENTS

- HI70459 0.05M Sulfuric Acid (1 L)
- HI70436 Deionized Water (1 gal)



ACCESSORIES

- HI70300L Storage Solution (500 mL)
- HI7082 Electrode Fill Solution (4 x 30 mL)
- HI7004L pH 4.01 Buffer Solution
- HI7007L pH 7.01 Buffer Solution
- HI7010L pH 10.01 Buffer Solution
- HI740036P 100 mL Plastic Beaker (10 pcs)
- 10 mL Class A Volumetric Pipette

DEVICE PREPARATION

- Connect the pH electrode and temperature probe to the titrator.
- Install a 25 mL burette filled with 0.05M sulfuric acid (HI70459) on pump one and verify that no air bubbles are present in the burette or tubing. If necessary prime the burette until all the air has been removed completely.
- For the determination of the exact concentration of the 0.05M sulfuric acid, follow *HI0703EN 0.05M Sulfuric Acid* Titrant Concentration.
- Press  from the main screen. Use the arrow keys to highlight *HI1008EN Neutralization w/H2SO4* and press .

ELECTRODE PREPARATION

- Press  from the main screen, if necessary select the analog board and press .
- Calibrate the electrode using pH 4.01, 7.01 and 10.01 buffers. Refer to the instruction manual for calibration procedure.

SAMPLE PREPARATION

- Use a class A volumetric pipette to transfer exactly 10.00 mL of sample to a clean 100 mL plastic beaker.
- Add deionized water to the 50 mL mark on the beaker.

ANALYSIS

- Place the beaker under the stirrer assembly and lower it to immerse the pH electrode, temperature probe and stirrer. Ensure that the reference junction of the pH electrode is 5 to 6 mm below the surface.

Note: *The dispensing tip should be slightly submerged in the sample.*

- Press , the titrator will start the analysis.
- At the end of the titration, after detection of the equivalence point, "Titration Completed" will appear with the result. The result is expressed in **meq/L**.
- Remove the pH electrode and stirrer from the sample and rinse them thoroughly with deionized water.
- Record the result.

METHOD PARAMETERS

Name: Neutralization w/ H2SO4
 Method Revision: 3.0
 Stirrer Configuration:
 Stirrer: Stirrer 1
 Stirring Speed: 1400 RPM
 Pump Configuration:
 Titrant Pump: Pump 1
 Dosing Type: Dynamic
 Min Vol: 0.050 mL
 Max Vol: 0.500 mL
 delta E: 20.000 mV
 End Point Mode:pH 1EQ point, 1st Der
 Recognition Options:
 Threshold: 50 mV/mL
 Range: NO
 Filtered Derivatives: NO
 Pre-Titration Volume: 0.000 mL
 Pre-Titration Stir Time: 0 sec
 Measurement Mode: Signal Stability
 delta E: 1.0 mV
 delta t: 2 sec
 Min wait: 2 sec
 Max wait: 15 sec
 Electrode Type: pH
 Blank Option: No Blank
 Calculations: Sample Calc. by Volume
 Dilution Option: Disabled
 Titrant Name: 0.05M H2SO4
 Titrant Conc.: 5.0000E-2 M (mol/L)
 Analyte Size: 10.000 mL
 Analyte Entry: Fixed
 Maximum Titrant Volume: 20.000 mL
 Potential Range:-2000.0 to 2000.0 mV
 Volume/Flow Rate: 25 mL/50.0 mL/min
 Signal Averaging: 1 Reading
 Significant Figures: XXXXX

CALCULATIONS

Calculations: Sample Calc. by Volume
 Titrant units: M (mol/L)
 Titrant volume dosed: V (L)
 Final result units: meq/L
 Titrant Conc.: 5.0000E-2 M (mol/L)
 Sample/Titrant: 2.000 eq/mol
 Sample Volume: 10.000 mL

$$\frac{\text{meq}}{\text{L}} = \frac{\text{V(L)} * 1000 * 0.05 * 2.0 * 1000}{10.0}$$

RESULTS

Titration Report

Method Name: Neutralization w/ H2SO4
 Time & Date: 09:46 August 1, 2018
 Report ID: Ti_00027

Titration Results

Method Name: Neutralization w/ H2SO4
 Time & Date: 09:46 August 1, 2018
 Analyte Size: 10.000 mL
 End Point Volume: 9.562 mL
 mV Equivalence Point: 7.966
 Result: 95.620 meq/L
 Initial & Final pH: 11.655 to 6.248
 Titration Duration: 1:24 [mm:ss]
 Titration went to Completion

Analyst Signature: _____

HI1009EN NEUTRALIZATION WITH SODIUM HYDROXIDE 0 to 200 meq/L

DESCRIPTION

Method for the determination of strong or weak acid concentration by titration of a sample to the equivalence point with sodium hydroxide. The results are expressed as meq/L.

ELECTRODE

- HI1131B Combination pH Electrode
- HI7662-T Temperature Probe

REAGENTS

- HI70456 0.1N Sodium Hydroxide (1 L)
- HI70436 Deionized Water (1 gal)

ACCESSORIES

- HI70300L Storage Solution (500 mL)
- HI7082 Electrode Fill Solution (4 x 30 mL)
- HI7004L pH 4.01 Buffer Solution
- HI7007L pH 7.01 Buffer Solution
- HI7010L pH 10.01 Buffer Solution
- HI740036P 100 mL Plastic Beaker (10 pcs)
- 10 mL Class A Volumetric Pipette

DEVICE PREPARATION

- Connect the pH electrode and temperature probe to the titrator.
- Install a 25 mL burette filled with 0.1N sodium hydroxide (HI70456) on pump one and verify that no air bubbles are present in the burette or tubing. If necessary prime the burette until all the air has been removed completely.
- For the determination of the exact concentration of the 0.1N sodium hydroxide, follow *HI0001EN 0.1N Sodium Hydroxide Titrant Concentration*
- Press Select Method from the main screen. Use the arrow keys to highlight *HI1009EN Neutralization w/NaOH* and press Select.

ELECTRODE PREPARATION

- Press Mode from the main screen, if necessary select the analog board and press pH.
- Calibrate the electrode using pH 4.01, 7.01 and 10.01 buffers. Refer to the instruction manual for calibration procedure.

SAMPLE PREPARATION

- Use a class A volumetric pipette to transfer exactly 10.00 mL of sample to a clean 100 mL plastic beaker.
- Add deionized water to the 50 mL mark on the beaker.

ANALYSIS

- Place the beaker under the stirrer assembly and lower it to immerse the pH electrode, temperature probe and stirrer. Ensure that the reference junction of the pH electrode is 5 to 6 mm below the surface.

Note: The dispensing tip should be slightly submerged in the sample.

- Press start stop, the titrator will start the analysis.
- At the end of the titration, after detection of the equivalence point, "Titration Completed" will appear with the result. The result is expressed in meq/L.
- Remove the pH electrode and stirrer from the sample and rinse them thoroughly with deionized water.
- Record the result.

METHOD PARAMETERS

Name: Neutralization w/ NaOH
 Method Revision: 3.0
 Stirrer Configuration:
 Stirrer: Stirrer 1
 Stirring Speed: 1400 RPM
 Pump Configuration:
 Titrant Pump: Pump 1
 Dosing Type: Dynamic
 Min Vol: 0.050 mL
 Max Vol: 0.500 mL
 delta E: 20.000 mV
 End Point Mode:pH 1EQ point, 1st Der
 Recognition Options:
 Threshold: 50 mV/mL
 Range: NO
 Filtered Derivatives: NO
 Pre-Titration Volume: 0.000 mL
 Pre-Titration Stir Time: 0 sec
 Measurement Mode: Signal Stability
 delta E: 1.0 mV
 delta t: 2 sec
 Min wait: 2 sec
 Max wait: 15 sec
 Electrode Type: pH
 Blank Option: No Blank
 Calculations: Sample Calc. by Volume
 Dilution Option: Disabled
 Titrant Name: 0.1N NaOH
 Titrant Conc.: 0.1000 N(eq/L)
 Analyte Size: 10.000 mL
 Analyte Entry: Fixed
 Maximum Titrant Volume: 20.000 mL
 Potential Range:-2000.0 to 2000.0 mV
 Volume/Flow Rate: 25 mL/50.0 mL/min
 Signal Averaging: 1 Reading
 Significant Figures: XXXXXX

CALCULATIONS

Calculations: Sample Calc. by Volume
 Titrant units: N (eq/L)
 Titrant volume dosed: V (L)
 Final result units: meq/L
 Titrant Conc.: 5.0000E-2 M (mol/L)
 Sample/Titrant: 0.1000 N(eq/L)
 Sample Volume: 10.000 mL

$$\frac{\text{meq}}{\text{L}} = \frac{\text{V(L)} * 1000 * 0.1 * 1.0 * 1000}{10.0}$$

RESULTS

Titration Report

Method Name: Neutralization w/ NaOH
 Time & Date: 10:29 August 2, 2018
 Report ID: Ti_00017

Titration Results

Method Name: Neutralization w/ NaOH
 Time & Date: 10:29 August 2, 2018
 Analyte Size: 10.000 mL
 End Point Volume: 15.970 mL
 pH Equivalence Point: 8.431
 Result: 159.70 meq/L
 Initial & Final pH: 2.675 to 10.316
 Titration Duration: 3:20 [mm:ss]
 Titration went to Completion

Analyst Signature: _____

HI1011EN TROUBLESHOOTING 1

DESCRIPTION

Method for verifying the dosing and potentiometric signal accuracy of the titrator. This method should be used to troubleshoot a titrator equipped with a 25 mL burette. The titrator dispenses a 20.00 mL pre-titration volume, waits 20 seconds and dispenses an additional 20.00 mL dose, bringing the total volume to 40.00 mL. This procedure can also be used to check the stability of the mV and temperature channels.

The dosing accuracy of the 25 mL burette is ± 0.025 mL ($\pm 0.1\%$ of the full volume).

If the results are not correct, check all fittings for leakage, and burette and tubing for air bubbles. Repeat the measurement.



REFERENCE

ISO/TC 48/SC1N 380E and 383E: "Piston and/or Plunger Operated Volumetric Apparatus"

ACCESSORIES

- HI762000C 0°C Temperature Key
- HI762070C 70°C Temperature Key
- HI70436 Deionized Water (1 gal)
- HI7662-T Temperature Probe
- Shorting Cap
- Narrow Neck Beaker
- Analytical Balance with 0.0001g resolution

DEVICE PREPARATION

- Connect the shorting cap to the BNC socket on Analog Board 1
- Install a 25 mL burette filled with room temperature deionized water (HI70436) on pump one and verify that no air bubbles are present in the burette or tubing. If necessary prime the burette until all the air has been removed completely.
- Press  from the main screen. Use the arrow keys to highlight *HI1011EN Troubleshooting 1* and press .

LARGE DOSE DISPENSING PROCEDURE

- Add a small amount of deionized water to a narrow neck beaker.

- Place the narrow neck beaker on an analytical balance and zero the balance.
- Place the dosing tip through the neck of the beaker. Take care not to immerse it in the liquid during dispensing and not to touch the beaker walls.
- Press .
- Write down the exact weight displaced on the balance after each dose.
- This procedure can be repeated on pump 2.

Other burette sizes can be checked using the following settings, see instruction manual for accuracy:

Burette Volume	Pre-titration Volume	Max. Titrant Volume
5 mL	4.000 mL	8.000 mL
10 mL	8.000 mL	16.000 mL

METHOD PARAMETERS

```

Name: Troubleshooting 1
Method Revision: 3.0
Stirrer Configuration:
  Stirrer: Stirrer 1
  Stirring Speed: 0 RPM
Pump Configuration:
  Titrant Pump: Pump 1
Dosing Type: Linear - 20.000 mL
End Point Mode: Fixed 10.0 mV
Pre-Titration Volume: 20.000 mL
Pre-Titration Stir Time: 0 sec
Measurement Mode: Timed Increment
  Time interval: 20 sec
Electrode Type: Shorting Cap
Blank Option: No Blank
Calculations: No Formula (mL only)
Titrant Name: DI Water
Maximum Titrant Volume: 40.000 mL
Potential Range: -2000.0 to 2000.0 mV
Volume/Flow Rate: 25 mL/50.0 mL/min
Signal Averaging: 1 Reading
Significant Figures: XXXXX
  
```

CALCULATIONS

$$V = m * \frac{1}{\rho} * \left(1 + \frac{\rho_{\text{air}}}{\rho_L} - \frac{\rho_{\text{air}}}{\rho_{\text{std}}} \right)$$

- V Volume of measure mass of water (mL)
 m Measure mass of water (g)
 ρ_L Density of dispensed water (g/mL)
 ρ_{air} Density of ambient air (g/mL)
 ρ_{std} Density of calibration standard weight (g/mL)

ALTERNATIVE CALCULATIONS

If the actual values of the above parameters are not accessible the following equation can be used:

$$V = M * F$$

- V Volume of measured mass of water (mL)
 F Transformation factor

The values from the table have been calculated by correcting the air and water density with temperature, assuming the density of dry air $\rho_{\text{air}} = 0.0012$ g/mL and density of calibration steel standard weigh $\rho_{\text{STD}} = 8$ g/mL.

Temperature (°C)	Factor
17.0	1.002290
18.0	1.002467
19.0	1.002654
20.0	1.002853
21.0	1.003061
22.0	1.003282
23.0	1.003512
24.0	1.003752
25.0	1.004002
26.0	1.004261
27.0	1.004531
28.0	1.004809
29.0	1.005097
30.0	1.005395

TEMPERATURE CHANNEL FAST CHECK PROCEDURE

- Connect the shorting cap to the BNC socket on Analog Board 1.
- Connect the HI762000C 0°C temperature key to the RCA socket (temperature sensor input) on Analog Board 1.

- On the main screen select **Mode** if necessary select the analog board and press **mV**.
- The titrator should display ATC 0.0 ± 0.4°C with no fluctuations or drift.
- Connect the HI762070C 70°C temperature key to the RCA socket (temperature sensor input) on Analog Board 1.
- The titrator should display ATC 70.0 ± 0.4°C with no fluctuations or drift.
- This procedure can be repeated on analog board 2.

TEMPERATURE & mV CHANNEL LOGGING PROCEDURE

- Connect the shorting cap to the BNC socket on Analog Board 1.
- Connect the HI762000C 0°C temperature key to the RCA socket (temperature sensor input) on Analog Board 1.
- On the main screen select **Mode** if necessary select the analog board and press **mV**.
- Press **mV Setup** and use the arrow keys to highlight Logging Interval. Set the logging interval to 15 seconds and press **Accept**. Press **Escape** to return to the main screen.
- Press the **results** key and use the arrow keys to highlight Setup pH/mV/ISE Report, press **Select**.
- Select Potential and Temperature and Units. All other fields should be unselected.
- Press **Save Report** to return to the Data Parameters screen.
- Press **Escape** to return to the main screen.
- Once on the main screen press **Start Log** to start the automatic log.
- Let the log run for about 10 minutes. Press **Stop Log** to stop the automatic log.
- Press **results**, use the arrow keys to highlight Review Last Analysis Report, and press **Select**.
- The mV column should display 0.0 ± 0.1 mV and the temperature column should display 0.0°C ± 0.4°C.
- This procedure can be repeated using the HI762070C 70°C temperature key and on analog board 2.

HI1012EN TROUBLESHOOTING 2

DESCRIPTION

Method for verifying the dosing of the titrator. This method should be used to troubleshoot a titrator equipped with a 25 mL burette. The titrator dispenses a 10.00 mL pre-titration volume, waits 20 seconds and dispenses an additional 0.5 mL dose twenty times, waiting 20 seconds between each dose, bringing the total volume to 20 mL. This procedure can also be used to check the stirrer functionality.

The dosing accuracy of the 25 mL burette is ± 0.025 mL ($\pm 0.1\%$ of the full volume).

If the results are not correct, check all fittings for leakage, and burette and tubing for air bubbles. Repeat the measurement.



REFERENCE

ISO/TC 48/SC1N 380E and 383E: "Piston and/or Plunger Operated Volumetric Apparatus"

ACCESSORIES

- HI762000C 0°C Temperature Key
- HI70436 Deionized Water (1 gal)
- HI7662-T Temperature Probe
- Shorting Cap
- Narrow Neck Beaker
- Analytical Balance with 0.0001g resolution

DEVICE PREPARATION

- Connect the shorting cap to the BNC socket on Analog Board 1
- Install a 25 mL burette filled with room temperature deionized water (HI70436) on pump one and verify that no air bubbles are present in the burette or tubing. If necessary prime the burette until all the air has been removed completely.
- Press  from the main screen. Use the arrow keys to highlight *HI1012EN Troubleshooting 2* and press .

SMALL DOSE DISPENSING PROCEDURE

- Add a small amount of deionized water to a narrow neck beaker. By doing this the air space in the beaker will be vapor-saturated minimizing evaporation.
- Place the narrow neck beaker on an analytical balance and zero the balance.
- Place the dosing tip through the neck of the beaker. Take care not to immerse it in the liquid during dispensing and not to touch the beaker walls.
- Press .
- Write down the exact weight displaced on the balance after each dose.
- This procedure can be repeated on pump 2.

Other burette sizes can be checked using the following settings, see instruction manual for accuracy:

Burette Volume	Pre-titration Volume	Max. Titrant Volume
5 mL	4.000 mL	8.000 mL
10 mL	8.000 mL	16.000 mL

METHOD PARAMETERS

Name: Troubleshooting 2
 Method Revision: 3.0
 Stirrer Configuration:
 Stirrer: Stirrer 1
 Stirring Speed: 0 RPM
 Pump Configuration:
 Titrant Pump: Pump 1

Dosing Type: Linear - 0.500 mL
 End Point Mode: Fixed 10.0 mV
 Pre-Titration Volume: 10.000 mL
 Pre-Titration Stir Time: 0 sec
 Measurement Mode: Timed Increment
 Time interval: 10 sec
 Electrode Type: Shorting Cap
 Blank Option: No Blank
 Calculations: No Formula (mL only)
 Titrant Name: DI Water
 Maximum Titrant Volume: 20.000 mL
 Potential Range: -2000.0 to 2000.0 mV
 Volume/Flow Rate: 25 mL/50.0 mL/min
 Signal Averaging: 1 Reading
 Significant Figures: XXXXX

CALCULATIONS

$$V = m * \frac{1}{\rho} * \left(1 + \frac{\rho_{\text{air}}}{\rho_L} - \frac{\rho_{\text{air}}}{\rho_{\text{std}}} \right)$$

- V Volume of measure mass of water (mL)
- m Measure mass of water (g)
- ρ_L Density of dispensed water (g/mL)
- ρ_{air} Density of ambient air (g/mL)
- ρ_{std} Density of calibration standard weight (g/mL)

ALTERNATIVE CALCULATIONS

If the actual values of the above parameters are not accessible the following equation can be used:

$$V = M * F$$

- V Volume of measured mass of water (mL)
- F Transformation factor

The values from the table have been calculated by correcting the air and water density with temperature, assuming the density of dry air $\rho_{\text{air}} = 0.0012$ g/mL and density of calibration steel standard weigh $\rho_{\text{STD}} = 8$ g/mL.

Temperature (°C)	Factor
17.0	1.002290
18.0	1.002467
19.0	1.002654
20.0	1.002853
21.0	1.003061
22.0	1.003282
23.0	1.003512
24.0	1.003752
25.0	1.004002
26.0	1.004261
27.0	1.004531
28.0	1.004809
29.0	1.005097
30.0	1.005395

STIRRING SPEED FAST CHECK PROCEDURE

- On the main screen select **Mode** if necessary select the analog board and press **mV**.
- Press **mV Setup** and use the arrow keys to highlight Stirrer Configuration. Use the arrow keys to highlight Stirrer 1. Press **Accept**.
- Use the arrow keys to highlight String Speed. Use the numeric keypad to enter 200 rpms then press **Accept**.
- Press **Escape** to exit the mV Setup screen.
- From the main screen, press **stir**, use the up arrow key to increase the stir speed slowly to 2500 rpms.
- Check that the propeller continues to increase speed, following the commands.
- This procedure can be repeated on stirrer 2.

PART 4:

TITRATION THEORY



1. TITRATION THEORY

1.1. INTRODUCTION

A titration is a quantitative, volumetric procedure used in analytical chemistry to determine the concentration of an analyte (the species being measured) in solution. The concentration of the analyte is determined by slowly adding a titrant to the solution. As the titrant is added, a chemical reaction occurs between the titrant and the analyte.

Titration reactions are relatively fast, simple reactions that can be expressed using a chemical equation. The titration reaction continues as the titrant is added until all of the analyte is consumed and the analyte reacts completely and quantitatively with the titrant.

The point at which all of the analyte has been reacted is called the equivalence point, also known as the theoretical or stoichiometric endpoint. This point is accompanied by an abrupt physical change in the solution, which sharply defines the endpoint of the reaction. The physical change associated with the titration endpoint can be produced by the titrant, or an indicator, and can be detected visually or by physical measurements.

Titration cannot be used to determine the quantity of all analytes.

The chemical reaction between the titrant and analyte must fulfill four requirements:

- Must be fast and occur within approximately one second after the titrant is added
- Must go to completion
- Must have well-known stoichiometry (reaction ratios)
- A convenient endpoint or inflection point

Titration provides many advantages over alternative methods; they are highly precise, quickly performed and require relatively simple apparatus and instrumentation.

1.2. USES OF TITRATIONS

- Acid content of plant effluents, food (e.g.: cheese and wine), plating and etching baths, petroleum products, drugs
- Base content of fertilizer (containing ammonia), bleach, minerals
- Hardness in water
- Metal content of alloys, minerals, ores, clays, waters, plating baths, paints, paper, plant materials, biological fluids, petroleum products
- Moisture content in foodstuffs, petrochemicals, plastics, pharmaceutical products
- Redox reagent concentrations such as available chlorine in potable water, peroxide, traces of oxidants and reductants in food, reductants in high temperature or high pressure boiler water, vitamin analysis

1.3. ADVANTAGES & DISADVANTAGES

Advantages of titration as an analytical technique:

- More precise results than many instrumental methods, such as measurement by electrode, the accuracy of the measurement is up to 0.1%
- Simple methods, reasonable capital costs and easy training
- Suitability to measure major components of a mixture or product
- Automation can reduce time and labor spent on each analysis

Disadvantages of titration as an analytical technique:

- The time it takes to prepare standards and titrants
- Good technique is required to achieve precise results (training and practice required)
- Not suitable for determining trace or minor components of a mixture or product
- Limited dynamic range, it may require additional sample preparation (dilution) and repeat analyses

2. TYPES OF TITRATIONS

2.1. TITRATIONS ACCORDING TO THE MEASUREMENT METHOD

2.1.1. AMPEROMETRIC TITRATIONS

An amperometric titration is performed by placing two electrodes (typically a metal ion-selective electrode and a reference electrode) into the sample solution and keeping the potential of the metal electrode at a selected voltage. The current that flows, due to the oxidation or reduction of a reactant or product, is plotted vs. volume of titrant to provide the titration curve and locate the equivalence point. Changes in the current are due to changes in the concentration of a particular species (being oxidized or reduced at the electrode).

Generally, the reaction between the analyte and titrant forms a new species. Depending on the titration, the reactants are electroactive and the products are not or vice-versa. Amperometric titration curves look like two straight lines intersecting at the equivalence point, this is due to the change in the electroactivity of the solution. **Figure 1A**, Amperometric titrations, shows an active analyte and non-reactive titrant. **Figure 1B** and **1D**, Amperometric titrations, shows a nonreactive analyte and a reactive titrant. **Figure 1C**, Amperometric titrations, shows a reactive analyte and titrant.

Many metal ions can be amperometrically titrated using a precipitation, complexation or redox reaction. Some metal ions and species that can be determined in this manner include silver, barium, halides, potassium, magnesium, palladium, molybdate, sulfate, tungstate, zinc, bismuth, cadmium, fluoride, indium, thallium, iodine and gold.

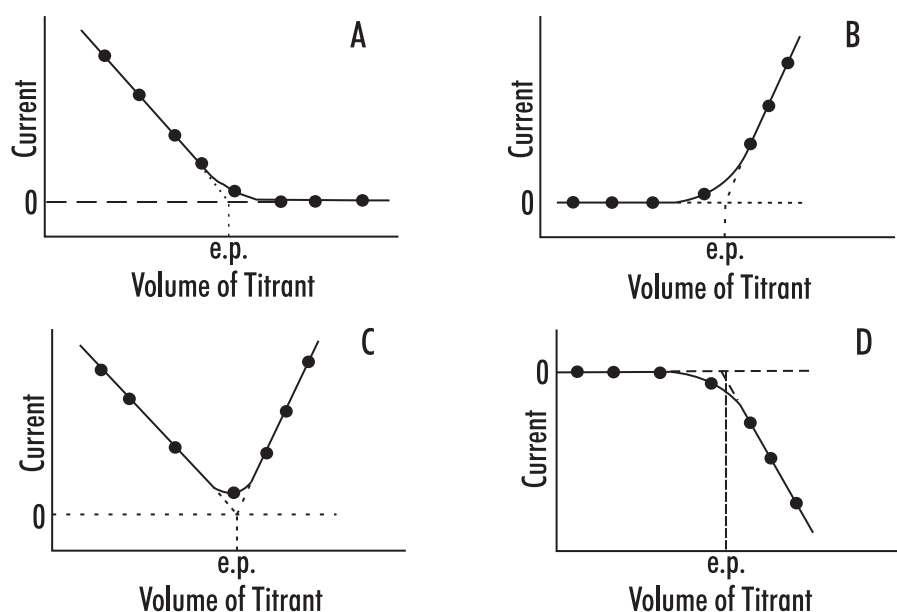

Figure 1: Amperometric titrations

2.1.2. POTENTIOMETRIC TITRATIONS

Potentiometric titrations are done by measuring the voltage across the solution using an electrode system. An electrode system consists of an indicator electrode and a reference electrode. As titrant is added, the variations in the potential of the indicator electrode, with respect to the reference electrode, are monitored to show the progress of the titration.

Potentiometry is the measurement of a potential under conditions of zero current flow. The measured potential can then be used to determine the analytical quantity of interest, generally a component concentration of the analyte solution. The potential that develops in the electrochemical cell is the result of the free energy change that would occur if the chemical phenomena were to proceed until the equilibrium condition has been satisfied.

There are many types of titrations where potentiometry can be used, e.g. pH electrodes for acid-base titrations, platinum ORP electrodes in redox titrations, ion-selective electrodes, such as chloride or fluoride for a specific ion titration, and silver electrodes for argentometric (silver-based) titrations.

In **Figure 2A**, Potentiometric titrations, the pH of the solution is plotted against the volume of titrant. In **Figure 2B**, Potentiometric titrations, the electrode potential is plotted against the volume of titrant.

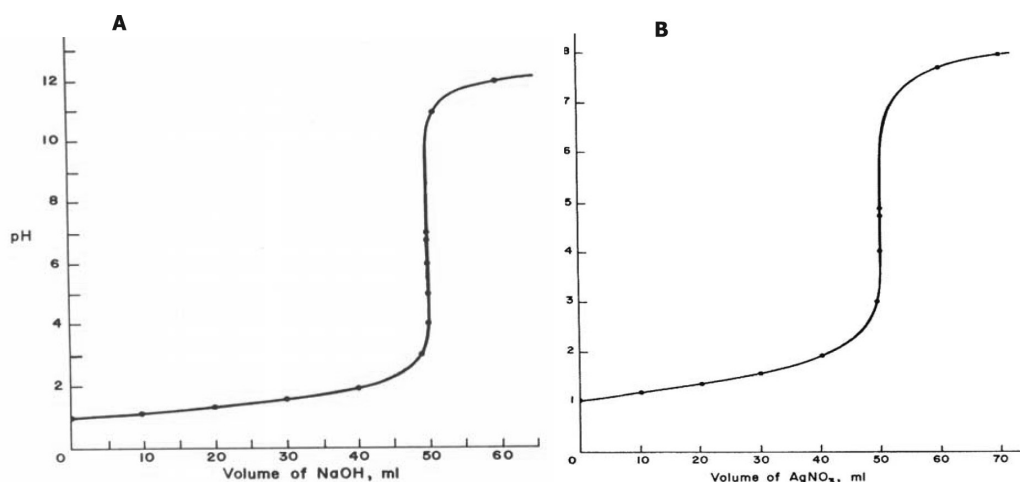

Figure 2: Potentiometric titrations

2.1.3. SPECTROPHOTOMETRIC TITRATIONS

The name comes from the method used to detect the endpoint of the titration, not its chemistry. Highly colored indicators that change color during the course of the titration are available for many titrations. More accurate data on the titration curve can be obtained if the light absorption is monitored instrumentally using a light source, a simple monochromator and a photodetector, rather than visually determining the color or light absorption change. Light absorption by either an indicator or by one of the reactants or products can be used to monitor the titration.

In **Figure 3A**, Spectrophotometric titrations, the absorption of a metal-indicator complex is being monitored. The absorption is constant while the metal is complexed by the ethylenediaminetetraacetic acid (EDTA) titrant. The metal indicator complex was stripped, causing a sharp break in the titration curve. The point where all the metal is complexed and stripped from the indicator is the equivalence point. This point is marked by "e.p." on the graph.

In **Figure 3B**, Spectrophotometric titrations, the metal complex is being measured while being titrated with EDTA. The new complex being formed is not colored and does not absorb light. The extrapolated intersection of the two lines determines the equivalence point.

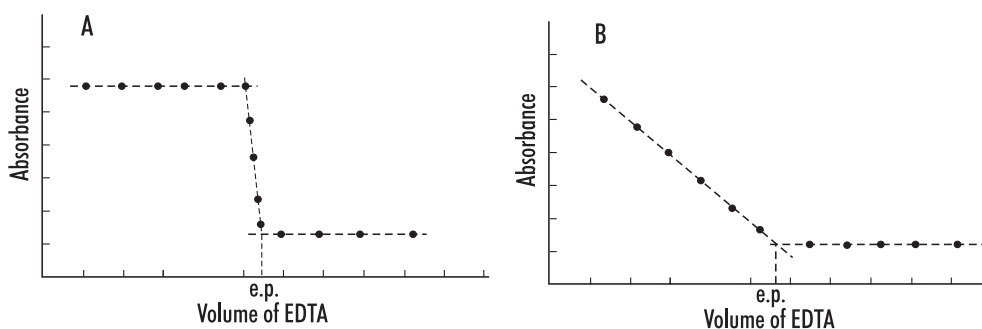

Figure 3: Spectrophotometric titrations

2.2. TITRATIONS ACCORDING TO THE REACTION TYPE

2.2.1. ACID-BASE TITRATIONS

Acid-base titrations are the most common type of titrations. They are based upon a reaction between an acid and a base, a stoichiometric neutralization or the exchange of protons. Virtually all acid-base titrations are carried out using a strong acid or a strong base as the titrant. The endpoint of a titration carried out with a weak acid or a weak base would be difficult to detect due to a small change in pH at the equivalence point.

Chemical indicators can be used to determine the endpoint. The indicator will change color to signify that the end of the titration has been reached. The color of the indicator is dependent upon the concentration of ions in the solution. An acid-base indicator is composed of a conjugate weak acid-weak base pair, where the two forms exhibit different colors depending on the pH of the solution. For an indicator, the acid ionization constant (K_a) is usually written as:

$$K_a = \frac{[H_3O^+][In^-]}{[HIn]}$$

HIn is the acid form of the indicator and In^- is the base form. At the center of the change region, the ratio of $[In^-]$ to $[HIn]$ is one, $[H_3O^+] = K_a$ and $pH = pK_a$. The color change region is usually ± 1 pH unit around this point.

Table 1, Aqueous acid-base chemical indicators, contains a list of aqueous acid-base chemical indicators, the pH range, the pK_a and the expected color (acid and base form). It is generally recommended to select a chemical indicator that has a pK_a as close to the endpoint of the titration as possible.

When chemical indicators are not suitable, a potentiometric pH titration can also be used. The pH of the solution is plotted versus the volume of titrant added.

Table 1: Aqueous acid-base chemical indicators

pH Range	Indicator	pK_a	Acid Form	Base Form
0.0 - 1.6	Methyl Violet		Yellow	Blue
1.2 - 2.8	Thymol Blue	1.65	Red	Yellow
3.2 - 4.4	Methyl Orange	3.46	Red	Yellow
3.8 - 5.4	Bromocresol Green	4.90	Yellow	Blue
4.8 - 6.0	Methyl Red	5.00	Red	Yellow
5.2 - 6.8	Chlorophenol Blue	6.25	Yellow	Red
6.0 - 7.6	Bromothymol Blue	7.30	Yellow	Blue
6.6 - 8.0	Phenol Red	8.00	Yellow	Red
7.4 - 9.0	Metacresol Purple	8.30	Yellow	Purple
8.0 - 9.6	Thymol Blue	9.20	Yellow	Blue
8.2 - 10.0	Phenolphthalein	9.50	Clear	Pink
9.4 - 10.6	Thymolphthalein		Clear	Blue
10.1 - 12.0	Alizarin Yellow R		Yellow	Red
11.4 - 12.6	Indigo Carmine		Blue	Yellow

Figure 4, Acid-base titration, shows a traditional strong acid-strong base titration curve, the volume of sodium hydroxide (NaOH) added to the solution is plotted against the pH of the solution. Note the abrupt change in the pH at the equivalence point.

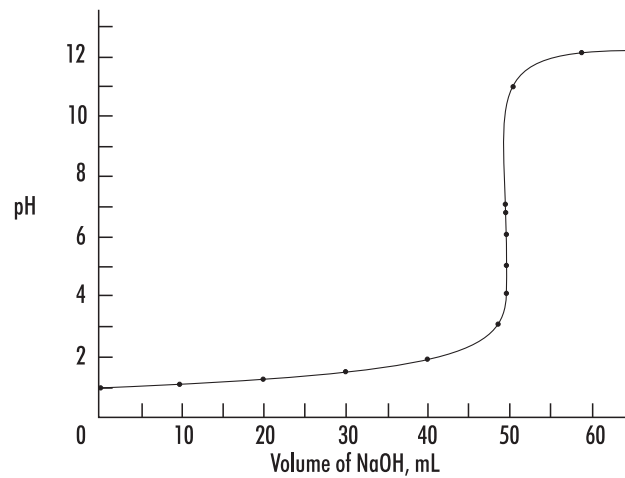

Figure 4: Acid-base titration

2.2.2. ARGENTOMETRIC TITRATIONS

Argentometric titrations use silver (nitrate) as the titrant and are generally precipitation titrations, as many silver salts are insoluble. These titrations are commonly used to titrate and determine the concentration of bromide, chloride, cyanide, iodide and sulfide.

Argentometric titrations can be done with Mohr's indicator. After all of the chloride has reacted, a red silver chromate precipitate is formed or the titration can be easily followed with a silver ISE (or chloride ISE for chloride titrations) and a reference electrode.

Figure 5, Argentometric titration, shows the titration of a sodium chloride solution with silver nitrate (AgNO_3). The volume of AgNO_3 is plotted against the potentiometric signal from a chloride ISE.

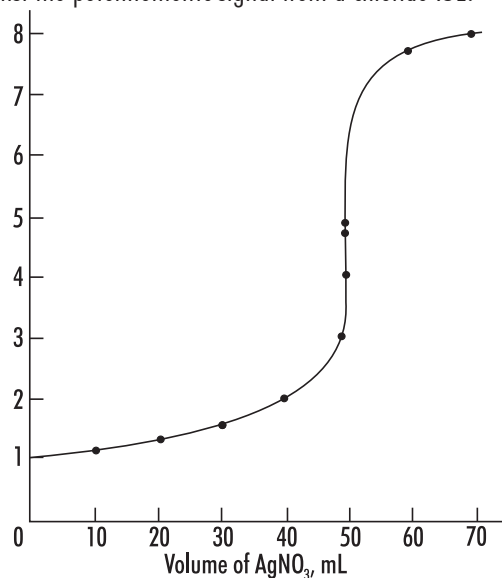

Figure 5: Argentometric titration

2.2.3. COMPLEXOMETRIC TITRATIONS

A complex is a species where a central metal ion is covalently bonded to one or more electron donating groups called ligands. In a complexometric titration, metal ions are titrated using a titrant that binds strongly to it. Often these titrants contain EDTA

or CDTA, polydentate ligands that form very stable coordination compounds with metal ions. The complexation reaction must be fast in order to be useful for direct titration. Some metal ions react too slowly with EDTA for a direct titration.

An indicator electrode that responds to the metal ion can be used to monitor the titration progress. The titration curve will appear similar to a potentiometric titration. Complexation indicators change color at the endpoint as all metal ions are “consumed” or complexed by the titrant.

Figure 6, Complexometric titration, shows a typically complexometric titration curve when using an indicator electrode that responds to the metal ion.

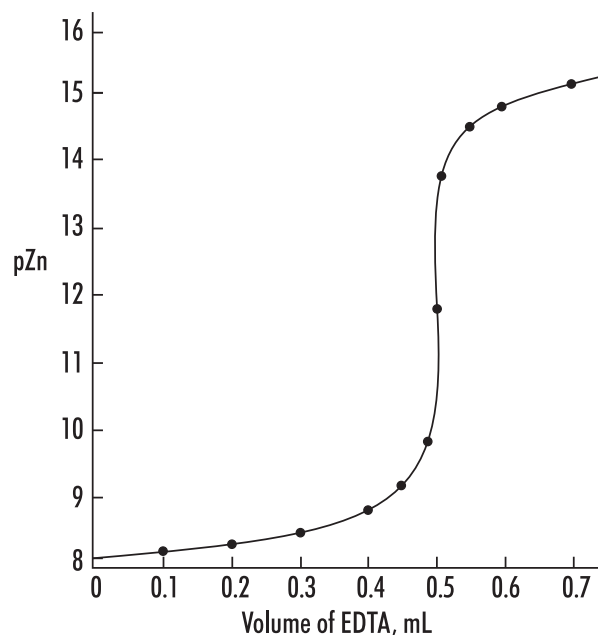

Figure 6: Complexometric titration

2.2.4. ION-SELECTIVE TITRATIONS

The most popular ion-selective titration is an acid-base titration. The hydrogen ion concentration is specifically measured and monitored during the titration process to locate the equivalence point. Using an ion-selective electrode (ISE) as the indicator electrode, the potentiometric signal (in mV) is used to directly follow a specific ion's concentration (or activity). Examples of ISE titrations include titrating fluoride with an aluminum titrant using a fluoride ISE, chloride with silver nitrate using a chloride ISE, sodium with a sodium ISE, etc. The equivalence point can be determined by plotting the mV value vs. the amount of titrant added.

2.2.5. NON-AQUEOUS SOLVENT ACID-BASE TITRATIONS

Non-aqueous solvents must be used to titrate very weak acids and bases due to the inherent leveling effect water has on all acids and bases dissolved in it. A wide variety of weak acids and bases can be titrated using non-aqueous solvents. Mixtures of acids or bases can often be individually analyzed in a single sequential titration.

2.2.5.1. TITRATION OF ACIDS

Weak acids with pK_a 's up to about 11 can be titrated in non-aqueous solvents. These include carboxylic acids, enols, phenols, imides, sulfonic acids and inorganic acids. Water or lower alcohols are suitable for titrating medium to strong acids (pK_a less than 5). Titrating a weaker acid with a strong base titrant requires a solvent less acidic than water or ethanol/methanol. Solvents such as acetone, acetonitrile, *t*-butyl alcohol, dimethylformamide, isopropanol and pyridine have been found to work well for acid-base titrations of strong, medium and weak acids/bases. Titrants include alcoholic potassium hydroxide and various sodium or potassium alkoxides in a 10:1 mixture of benzene/methanol. The best titrants are quaternary ammonium hydroxides (such as tetrabutylammonium hydroxide) due to good solubility of tetraalkylammonium salts of the titrated acids and the clean potentiometric titration curve obtained. **Figure 7**, Non-aqueous titration, shows an example of titration with tributylmethylammonium hydroxide titrant.

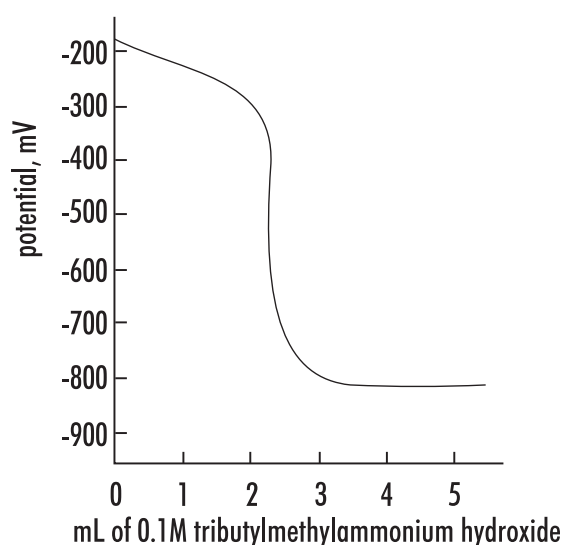

Figure 7: Non-aqueous titration

2.2.5.2. TITRATION OF BASES

Weak bases with pK_b 's up to about 11, which do not ionize with water, can be titrated in non-aqueous solvents. These bases include aliphatic and aromatic amines, basic nitrogen heterocycles, alkali metal and amine salts of acids, and many other organic basic compounds. Titrating a weak base with a strong acid titrant requires a basic solvent that is as weak as possible. Water and alcohols allow the titration of medium strength bases, such as aliphatic amines ($pK_b = 4$ to 5), but not the titration of weaker bases such as pyridine ($pK_b = 8.8$). Glacial acetic acid works well for weak bases and has been used extensively. Less basic solvents such as acetone, acetonitrile and nitromethane extend the range of titratable compounds.

The endpoint for non-aqueous titrations are usually determined potentiometrically using a pH glass electrode, a modified calomel or double junction reference electrode with a low-flow rate reference junction. Good potentiometric titration curves are obtained in most solvents, except those with very low dielectric constants such as benzene or chloroform, when high electrical resistance of the solvent causes unstable potentials.

2.2.6. PRECIPITATION TITRATIONS

Precipitation titrations allow for faster analysis when compared to gravimetric analysis, where a precipitate is formed, filtered, dried and weighed to analyze a compound. Typically silver halides, silver thiocyanate and a few mercury, lead, and zinc salts are titrated using this method. The chemical reactions must form an insoluble salt and precipitate out quickly in order to be analyzed by this method. When the reaction is not quick, a back titration can be used. A measured excess of the precipitating reagent (titrant) is added to force the reaction to occur, and then unreacted titrant is titrated with a standard solution of another reagent.

2.2.7. REDOX TITRATIONS

There are a number of oxidation-reduction reactions that can be used to determine unknown concentration by titration. If the reaction goes to completion, is fast and has an analytical signal available to follow it, a titration can be performed. The term “fast” means that each addition of titrant is reacted completely and the sensing electrode is able to detect the change in solution in less than one second. **Figure 8**, Redox titration, shows an example of a redox titration using Cerium (IV) as a titrant.

Redox titrations are potentiometric titrations where the mV signal from a combination ORP (redox) electrode (usually with a platinum indicator electrode) is used to follow the reaction of oxidant/reductant. The electrode potential is determined by the Nernst equation and is controlled by the oxidant/reductant ratio.

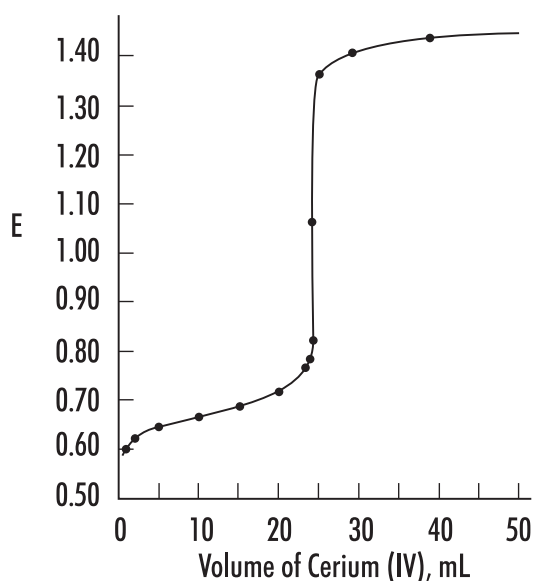

Figure 8: Redox titration

Visual indicators, such as Ferroin, are also available. The oxidized and reduced form of the indicator will have different colors and can be used to determine the endpoint.

Various reductants can be determined by titrants with oxidants such as potassium permanganate, potassium chromate or iodine. Commonly used reductants that are used as titrants include sodium thiosulfate and ferrous ammonium sulfate. As with acid-base titrations, the potential changes dramatically at the equivalence point.

2.2.8. KARL FISCHER TITRATIONS

This method is based on a well-defined chemical reaction between water and the Karl Fischer reagent. The chemistry provides excellent specificity for water determination. The method can be used to determine free and bound water in a sample matrix. The Karl Fischer method is widely considered to produce the most rapid, accurate and reproducible results and has the largest detectable concentration range spanning 1 ppm to 100%.

The determination of water content is one of the most commonly practiced methods in laboratories around the world. Knowledge of water content is critical to understanding chemical and physical properties of materials and ascertaining product quality. Water content determination is conducted on many sample types including pharmaceuticals and cosmetics, foods and natural products, organic and inorganic compounds, chemicals, solvents and gases, petroleum and plastic products as well as paints and adhesives. The KF method is verifiable and can be fully documented. As a result, Karl Fischer titration is the standard method for analysis of water in a multitude of samples as specified by numerous organizations including the Association of Official Analytical Chemists, the United States and European Pharmacopoeia, ASTM, American Petroleum Institute, British Standards and DIN.

2.3. TITRATIONS ACCORDING TO THE TITRATION SEQUENCE

2.3.1. BACK TITRATIONS

Back titrations are generally used when a reaction is too slow to be directly accomplished during a “direct” titration, where the reaction goes to completion within a few seconds. In a back titration, a large excess of a reagent is added to the sample solution, helping a slow reaction to go to completion. The unreacted, excess reagent is then titrated. The difference in the total volume of the first reagent added and amount determined from the second titration is the quantity of reagent required to complete the first reaction.

2.3.2. MULTIPLE ENDPOINT TITRATIONS

Under certain conditions, some titrations can exhibit more than one equivalence point and be titratable to the individual endpoints to determine the concentration of each individual component. Examples of these types of titrations include acid-base (different strengths acids or bases are in a mixture), redox (each species has a different reduction potential), complexometric (different species are separately titratable), and acid-base, using polyprotic acids (the pK_a of the different protons varies enough to separate them).

In **Figure 9A**, Multiple endpoint titrations, a titration of a polyprotic acid is shown, the different acid strengths of the first and second proton can be determined. **Figure 9B**, Multiple endpoint titrations, shows a titration with two different metal redox species, the different redox potentials allow the species to be separated. In **Figure 9C**, Multiple endpoint titrations, the solution being titrated contains a mixture of strong, weak, and very weak acids, the different pK_a 's allow the species to be separated.

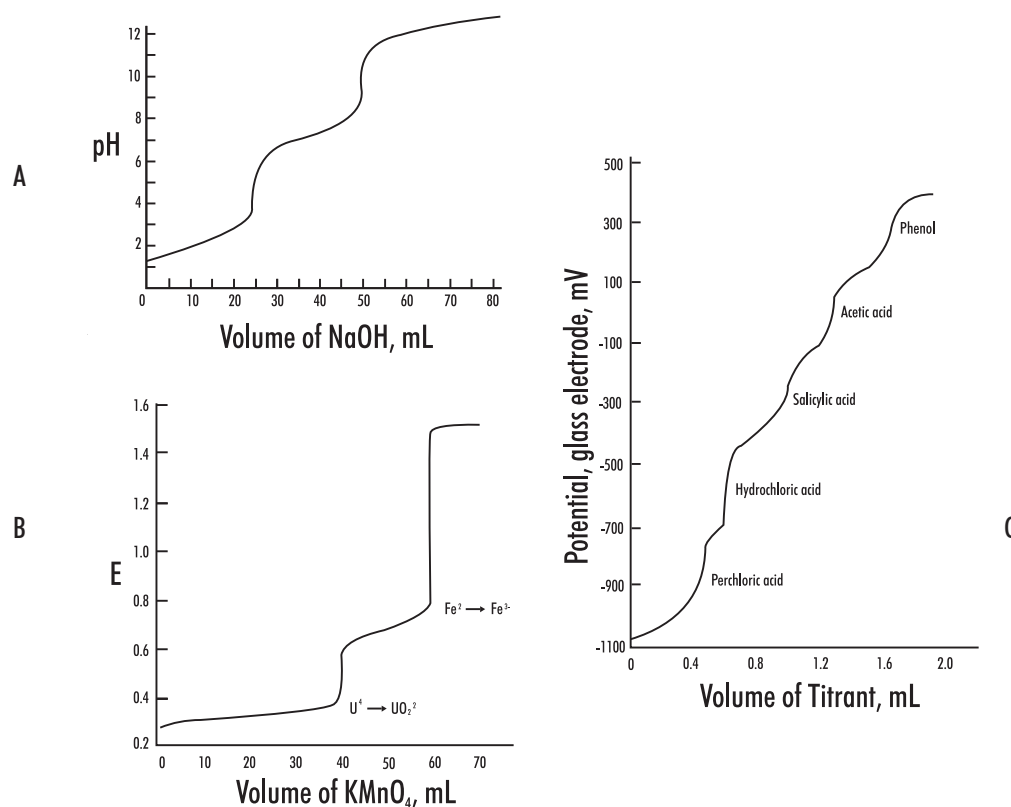

Figure 9: Multiple endpoint titrations

3. TITRATION PROCEDURE

3.1. MANUAL TITRATION

Apparatus required for manual titration include:

- Volumetric burette, for precisely controlled delivery of titrant to the reaction vessel
- Erlenmeyer, or similar flask, that facilitates constant mixing or swirling required to ensure solution homogeneity
- Volumetric pipettes for the precise addition of samples and indicator solutions
- Titrant solutions of known concentration
- A visual or instrumental indicator for detecting the completion of the reaction

A typical manual titration consists of the following steps:

- 1) A volumetric pipette is used to add a known volume of sample to the flask.
- 2) An indicator solution or instrument probe is added to the flask.
- 3) A burette is used to measure the addition of titrant to the flask and dispense titrant in a controlled manner.
- 4) Titrant is added via the burette until the method indication signals the reaction endpoint.
- 5) Analyte concentration is calculated based on the concentration and volume of titrant required to reach the endpoint.

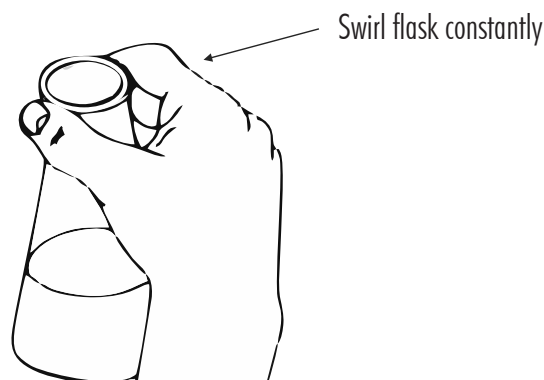
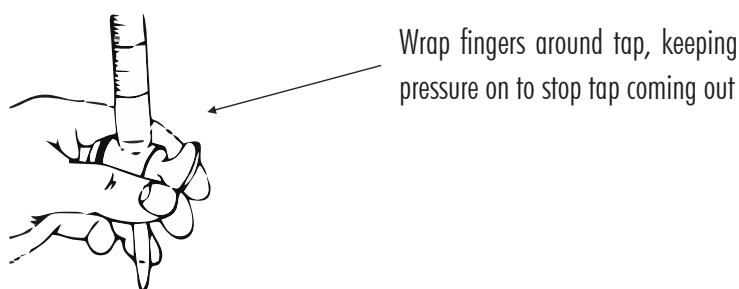

3.2. AUTOMATIC TITRATION

Automatic titrators are high-precision analytical instruments that deliver the titrant, monitor the physical change associated with the titration reaction, automatically stop at the endpoint and calculates the concentration of the analyte. Automatic titrators are best for repetitive titrations and high-accuracy analyses.

An automatic titrator must have an accurate liquid dispensing system. In high-accuracy systems like the **HI900**-series titrators, the liquid dispensing system consists of three main components: motor-driven syringe burette capable of accurately and precisely dispensing very small volumes of titrant, valve system capable of switching between titrant intake and outlet and a dispensing tip. These three main subsystem components must be as accurate as possible, with very low gear backlash in the burette pump, minimal piston seal flexing, precision ground inner diameter of the glass syringe, a low dead-volume valve, minimal evaporation/permeation, and chemically resistant tubing.

Apparatus required for automatic titration include:

- An automatic titrator, equipped with a burette
- A beaker
- An electronic stirring system, either a propeller stirrer or a magnetic stir bar and stir plate
- Volumetric pipettes for the precise addition of samples
- Standard titrant solutions of known concentration
- An electrode system that can be used to determine the endpoint of the titration

A typical automatic titration consists of the following steps:

- 1) Set up the automatic titrator according to the manufacturer's instructions.
- 2) Use a volumetric pipette to add a known volume of sample to the beaker.
- 3) Submerge the propeller stirrer or add the stir bar to the beaker and turn on.
- 4) Start the titration.
- 5) The titrator will automatically stop at the endpoint and determine the concentration of the analyte.

4. TITRATION RESULTS

4.1. ACCURACY

The factors most critical to achieving accurate results with the **HI900** titration systems are the concentration of the sample, size of the sample and having an optimized set of method parameters.

4.2. REPEATABILITY

Repeatability or the agreement between replicate determinations, is expressed quantitatively as the relative standard deviation (RSD).

4.3. SOURCES OF ERROR

One of the advantages of volumetric analysis is excellent accuracy and precision. The sources of error can be grouped into sampling, titrant and standards, chemical reactions, endpoint determination and calculations.

4.3.1. SAMPLING ERRORS

- Selection of a non-homogeneous or non-representative sample
- Sample changed or was contaminated during collection, storage or transfers
- Poor technique when transferring sample to beaker or flask
- Errors in the balance (calibrate and check balance regularly)

4.3.2. PREPARATION ERRORS

Incorrect preparation due to:

- Poor technique in weighing the salt or when transferring to volumetric glassware
- Low-purity salts or water used to make titrant and standard
- Dirty or wet glassware
- Improper storage of titrant or standard which allows water gain, evaporation or deterioration
- Failure to standardize frequently, to adjust for change in titrant
- Failure to flush titrator tubing with a volume of titrant before standardizing
- Volume errors from pipettes and volumetric flasks (grade A glassware is required)
- Balance errors when weighing out salts (calibrate and check balance regularly)

4.3.3. DISPENSING ERRORS

Incorrect dispensing due to:

- Dead valve volume and leaking valve
- Inaccuracy in motor drive and gear lash or backlash
- Poor burette or piston seal
- Non-uniform diameter of burette glass cylinder
- Chemical incompatibility with tubing or bubble generation
- Density or temperature changes in titrant
- Inadequate volume to cover electrode

4.3.4. CHEMICAL REACTION ERRORS

- Inappropriate solvent or sample, resulting in side reactions
- Poor mixing in the titration vessel
- Reaction between titrant and sample is not rapid
- Reaction does not go to completion
- Reaction has side reactions

4.3.5. ENDPOINT DETERMINATION ERRORS

Most manual titrations use a visual indicator to indicate when the endpoint is reached and the titration should be stopped. Automatic titrators use instrumental methods to determine the end of a titration and the equivalence point. There are two predominant methods used to determine the equivalence point, first derivative and second derivative.

The first derivative is often used to determine the inflection point. The inflection point of the titration curve (mV vs. volume) is normally assumed to be the equivalence point. The maximum value of the first derivative (ΔmV vs. ΔV) corresponds to the theoretical equivalence point. During a titration it is rare to have a data point exactly at the first derivative maximum, the maximum value is determined by interpolating the first derivative data points.

The second derivative (ΔmV^2 vs. ΔV^2) can also be used to determine the equivalence point, and can offer advantages over the first derivative method. Second derivatives have increased sensitivity to smaller inflection points and easier numerical evaluation of the actual equivalence point. The value where the second derivative is equal to zero is the equivalence point. The second derivative requires fewer points located near the equivalence point, where data is often not obtained or not as reliable.

Errors in determining the endpoint can result from:

- Incorrect signals from the sensor
- Sensor drift
- Sensor or instrument has slow response (it is recommended to keep the sensors in good condition)
- Inappropriate setting on the titrator

5. CALCULATIONS

The main variables used in calculating a result from a titration are the sample volume, the concentration of the titrant, and the volume of titrant required to reach the equivalence point. At the equivalence point, an equal number of equivalents of the analyte and titrant has been added.

5.1. SAMPLE CALCULATION BY MASS

$$C_{\text{sample}} = \frac{V_{\text{titrant}} \times C_{\text{titrant}} \times \text{Ratio} \times \text{FW}_{\text{analyte}}}{m_{\text{sample}}} \times 100$$

C_{sample}	Sample Concentration (g/100g)
V_{titrant}	Volume of Titrant
C_{titrant}	Titrant Concentration (eq/L)
Ratio	Equivalence Ratio of analyte / titrant (mol analyte / eq titrant)
$\text{FW}_{\text{analyte}}$	Formula Weight of the Analyte (g/mol)
m_{sample}	Mass of Sample (g)

5.2. SAMPLE CALCULATION BY VOLUME

$$C_{\text{sample}} = \frac{V_{\text{titrant}} \times C_{\text{titrant}} \times \text{Ratio} \times \text{FW}_{\text{analyte}}}{V_{\text{sample}}} \times 100$$

C_{sample}	Sample Concentration (g/100mL)
V_{titrant}	Volume of Titrant
C_{titrant}	Titrant Concentration (eq/L)
Ratio	Equivalence Ratio of analyte / titrant (mol analyte / eq titrant)
$\text{FW}_{\text{analyte}}$	Formula Weight of the Analyte (g/mol)
V_{sample}	Volume of Sample (mL)

5.3. STANDARDIZE TITRANT BY MASS

Titrant standardization is the second most important calculation in titrations. A primary standard is titrated in order to determine the concentration of the titrant. This is essentially a typical titration calculated in “reverse”, where the concentration of the solution is known and the titrant is unknown.

$$C_{\text{titrant}} = \frac{m_{\text{standard}} \times \text{Ratio}}{\text{FW}_{\text{standard}} \times V_{\text{titrant}}}$$

C_{titrant}	Titrant Concentration (N)
m_{standard}	Mass of Standard (g)
Ratio	Equivalence Ratio of titrant / standard (eq titrant / mol standard)
$\text{FW}_{\text{standard}}$	Formula Weight of the Standard (g/mol)
V_{titrant}	Volume of Titrant (L)

5.4. STANDARDIZE TITRANT BY VOLUME

Titrant standardization is the second most important calculation in titrations. A primary standard is titrated in order to determine the concentration of the titrant. This is essentially a typical titration calculated in “reverse”, where the concentration of the solution is known and the titrant is unknown.

$$C_{\text{titrant}} = \frac{V_{\text{standard}} \times (1 \text{ L}/1000 \text{ mL}) \times C_{\text{standard}}}{V_{\text{titrant}}}$$

C_{titrant}	Titrant Concentration (N)
V_{standard}	Volume of Standard (mL)
C_{standard}	Concentration of Standard (eq/L)
V_{titrant}	Volume of Titrant (L)

5.5. BLANK TITRATION

In a blank titration a pre-titration is performed, often times on the solvent to be used for the sample titration, and the titrant volume required to reach the endpoint is noted. This blank value nullifies error due to titrant required to react with the components of the titration solution matrix. The basic titration equation can be used for a blank titration, with the single modification that the volume of titrant used in the blank titration should be subtracted from the regular titration titrant volume.

$$C_{\text{sample}} = \frac{C_{\text{titrant}} \times (V_{\text{sample}} - V_{\text{blank}}) \times \text{Ratio} \times \text{FW}_{\text{analyte}}}{m_{\text{sample}}} \times 100$$

C_{sample}	Sample Concentration (g/100 g)
C_{titrant}	Titrant Concentration (eq/L)
V_{sample}	Volume of Titrant required for the sample (L)
V_{blank}	Volume of Titrant required for the blank (L)
Ratio	Equivalence ratio of analyte / titrant (mol analyte / eq titrant)
$\text{FW}_{\text{analyte}}$	Formula Weight of the Analyte (g/mol)
m_{sample}	Mass of Sample (g)

5.6. MULTIPLE ENDPOINT TITRATION

Some titrations have two or more endpoints, each corresponding to the equivalence point for a specific reaction. Multiple endpoint titrations are similar to a blank titration in that the volume of titrant required to reach the first endpoint is subtracted from the titrant volume used to reach the next sequential endpoint.

$$C_{\text{sample1}} = \frac{V_{\text{titrant1}} \times C_{\text{titrant}} \times \text{Ratio} \times \text{FW}_{\text{analyte1}}}{m_{\text{sample}}} \times 100$$

$$C_{\text{sample2}} = \frac{(V_{\text{titrant2}} - V_{\text{titrant1}}) \times C_{\text{titrant}} \times \text{Ratio} \times \text{FW}_{\text{analyte2}}}{m_{\text{sample}}} \times 100$$

$$C_{\text{sample3}} = \frac{(V_{\text{titrant3}} - V_{\text{titrant2}}) \times C_{\text{titrant}} \times \text{Ratio} \times \text{FW}_{\text{analyte3}}}{m_{\text{sample}}} \times 100$$

C_{sample1}	Sample 1 Concentration (g/100g)
C_{sample2}	Sample 2 Concentration (g/100g)
C_{sample3}	Sample 3 Concentration (g/100g)
$V_{\text{titrant 1}}$	Volume of titrant required to reach the first endpoint (L)
$V_{\text{titrant 2}}$	Volume of titrant required to reach the second endpoint (L)
$V_{\text{titrant 3}}$	Volume of titrant required to reach the third endpoint (L)
C_{titrant}	Concentration of Titrant (N)
Ratio	Equivalence Ratio of analyte / titrant (mol analyte / eq titrant)
$FW_{\text{analyte 1}}$	Formula Weight of the analyte 1 (g/mol)
$FW_{\text{analyte 2}}$	Formula Weight of the analyte 2 (g/mol)
$FW_{\text{analyte 3}}$	Formula Weight of the analyte 3 (g/mol)
m_{sample}	Mass of Sample (g)

5.6.1. BACK TITRATION

The equation used in back titration calculations is also similar to the equation for a blank titration. Instead of subtracting the initial amount of titrant needed to react with the blank, the amount of second titrant needed to react with the excess titrant added in the first titration is subtracted from the amount of the first titrant added. The difference between the two amounts is the amount of titrant necessary to reach the first equivalence point.

$$C_{\text{sample}} = \frac{(C_{\text{titrant1}} \times V_{\text{titrant1}} - C_{\text{titrant2}} \times V_{\text{titrant2}}) \times \text{Ratio} \times FW_{\text{analyte}}}{V_{\text{sample}}} \times 100$$

C_{sample}	Sample Concentration (g/100mL)
$C_{\text{titrant 1}}$	Concentration of Titrant 1 (N)
$V_{\text{titrant 1}}$	Volume of Titrant 1 (L)
$C_{\text{titrant 2}}$	Concentration of Titrant 2 (N)
$V_{\text{titrant 2}}$	Volume of Titrant 2 (L)
Ratio	Equivalence Ratio of analyte / titrant (mol analyte / eq titrant)
FW_{analyte}	Formula Weight of the analyte (g/mol)
V_{sample}	Volume of Sample (mL)

6. GLOSSARY

Acid

A chemical species that can donate one or more protons (hydrogen ions).

Acid-Base Titration

Stoichiometric neutralization titrations, based upon the reaction that occurs between an acid and a base.

Activity

A physical property corresponding to the concentration of all ions in a solution. Electrodes respond to activity.

Amperometric Titration

Titrations where the current flow between two electrodes (often a metal electrode and a reference electrode) are used to monitor the titration progress.

Analyte

The chemical species being measured in a titration.

Argentometric Titration

Titrations that use silver (nitrate) as the titrant. These titrations are typically precipitation titrations.

Automatic Titrator

An instrument designed to automatically carry out a titration. It will add the appropriate amount of titrant, determine the endpoint and calculate the results.

Back Titration

A type of titration where an excess amount of titrant is added to a sample, forcing a sluggish reaction to go to completion. The excess reagent is then "back" titrated with a second titrant.

Base

A chemical species that can accept one or more protons (hydrogen ions).

Biamperometric Indication

Uses a dual platinum pin electrode to measure the current flow through a titration solution.

Bivoltametric Indication

Uses a dual platinum pin electrode to measure the voltage required to maintain a constant current flow through a titration solution while constant voltage is applied across the platinum elements of the electrode.

Burette

A graduated cylindrical piece of laboratory glassware that is used to dispense precise amounts of solution.

Complex Ion

A species where a central metal ion is covalently bonded to one or more electron donating groups called ligands.

Complexometric Titrations

Metal ions are titrated using a titrant that binds strongly to it. The titrants often contain Ethylenediaminetetraacetic Acid (EDTA) or Cyclohexylenedinitrilotetraacetic Acid (CDTA).

Endpoint

The point where a titration is stopped because a physical change in the solution has indicated a completed titration. Titration endpoints typically coincide with the equivalence point. A fixed value endpoint (pH or mV) can be used as well. The titration will stop at the desired point regardless if the titration is complete.

Equivalence Point

The point where the quantity of titrant is stoichiometrically equal to the quantity of analyte.

Formal

The theoretical number of equivalents per liter of the solution. It is used in solutions where the exact concentration of a species may be affected by the other ions present, therefore the stated concentration may not be exactly correct.

Gravimetric Analysis

A quantitative determination of an analyte based on the mass of the solid.

Indicator Electrode

An electrode that responds to the species of interest. The electrode potential is proportional to the concentration or activity of that ion in the solution being measured.

Indicators

Chemical indicators are typically organic dyes that change form under different physical conditions, causing a color change that can be seen by an analyst. Typically used in manual titrations, chemical indicators have been replaced with electrometric indicators, which are used with automatic titrators.

Inflection Point

The point on a titration curve where the second derivative curve changes signs.

Ion-Selective Electrode (ISE)

An electrode that responds to a specific ion. The electrode potential is proportional to the concentration or activity of that ion in the solution being measured.

Karl Fischer Titration

A titration that uses a chemical reaction that is specific for determining water.

Manual Titration

A titration that is carried out by hand. The analyst must add the appropriate amount of titrant, determine the endpoint and calculate the results.

Molar

The concentration of a solute in a solution.

Mole (mol)

A quantity of a chemical species. The molecular weight of a substance in grams is equal to the mass of one mole of the substance. One mole is equal to 6.022×10^{23} atoms or molecules.

Monochromator

A device that allows only a narrow range of wavelengths to pass through it by separating the light into different wavelengths.

Multiple Endpoint Titration

A titration that reacts multiple species in solution, sequentially, using the same titrant. The concentration of each analyte can be determined from their respective endpoints.

Nernst Equation

The fundamental equation relating cell voltage to the concentration of a solution.

Neutralization

A chemical reaction where an acid and a base react to form a neutral salt and water.

Non-aqueous

A solution that does not contain water.

Non-aqueous Titration

A titration that is performed in non-aqueous solutions, typically used to titrate very weak acids and bases to eliminate the leveling effect water has on all acids and bases dissolved in it.

Normal

The concentration of a solution which accounts for any stoichiometric difference between the various species in a solution.

Oxidation / Reduction Potential (ORP)

The measurement describing whether a species wants to donate or accept electrons from other species in a redox reaction. If a solution's reduction potential is higher than the species it is reacting with, it will typically gain electrons or be reduced. If the potential is lower than the species it is reacting with, it will typically lose electrons or be oxidized.

Oxidant

The species that is accepting electrons in a redox reaction.

Pipette

Scientific apparatus that is used to deliver precise volumes of liquids.

Polyprotic Acid

Acids that are capable of donating more than one proton per acid molecule.

Potentiometric Titration

A titration in which the endpoint is determined by monitoring the voltage of the solution using an electrode.

Precipitation Titration

A titration in which the analyte reacts with the titrant to form an insoluble compound. The endpoint is typically detected with an ISE sensitive to either the analyte or titrant.

Reagent

The chemical added in a titration that causes the given reaction to occur.

Reduction-Oxidation Reaction (redox)

A chemical reaction in which the atoms involved in the reaction have their oxidation numbers changed. Reduction is the gain of electrons, which decreases the oxidation number. Oxidation is the loss of electrons, which increases the oxidation number.

Reductants

The electron donor in a redox reaction.

Reference Electrode

An electrode that supplies a constant electrode potential. It is used in combination with an "indicator" electrode, allowing for the "indicator" electrode potential to be measured.

Relative Standard Deviation (RSD)

A measure of the amount of relative variation in a set of data. It is calculated by dividing the standard deviation by the mean: $RSD = (\text{Standard Deviation of } X) * 100 / (\text{Mean of } X)$

Repeatability

The variation in sample measurements taken by a single person or instrument under the same conditions.

Spectrophotometric Titration

A titration in which the endpoint is marked by a change in color and/or color intensity.

Stoichiometry

The quantitative relationship of the reactants and products in a chemical reaction.

Titrant

The chemical added in a titration that causes the given reaction to occur.

Titration

A quantitative, volumetric procedure used in analytical chemistry to determine the concentration of an analyte in solution. The concentration of the analyte is determined by slowly adding a titrant to the solution. As the titrant is added, a chemical reaction between the titrant and the analyte occurs.

Titration Curve

A graph containing the physical data obtained for a titration. The data plotted is often an independent variable (volume of titrant) vs. a dependent variable (pH of the solution). From the titration curve, the equivalence point or endpoint can be determined.

Certification

All Hanna Instruments conform to the **CE European Directives**.



RoHS
compliant

Disposal of Electrical & Electronic Equipment. The product should not be treated as household waste. Instead hand it over to the appropriate collection point for the recycling of electrical and electronic equipment which will conserve natural resources.

Ensuring proper product and battery disposal prevents potential negative consequences for the environment and human health. For more information, contact your city, your local household waste disposal service, the place of purchase or go to www.hannainst.com.



Recommendations for Users

Before using this product, make sure it is entirely suitable for your specific application and for the environment in which it is used. Any variation introduced by the user to the supplied equipment may degrade the meters' performance. For yours and the meter's safety do not use or store the meter in hazardous environments.

Warranty

The **HI931** is warranted for two years against defects in workmanship and materials when used for its intended purpose and maintained according to instructions. Damage due to accidents, misuse, tampering or lack of prescribed maintenance is not covered.

If service is required, contact your local Hanna Instruments Office. If under warranty, report the model number, date of purchase, serial number and the nature of the problem. If the repair is not covered by the warranty, you will be notified of the charges incurred. If the instrument is to be returned to Hanna Instruments, first obtain a Returned Goods Authorization (RGA) number from the Technical Service department and then send it with shipping costs prepaid. When shipping any instrument, make sure it is properly packed for complete protection.

Hanna Instruments reserves the right to modify the design, construction or appearance of its products
without advance notice.

